

# LIFEPAK® 15 MONITOR/DEFIBRILLATOR

## Service Manual



## Section Navigator

### 1 Introduction

*page 11*

### 2 Safety

*page 29*

### 3 Device Description

*page 48*

### 4 Modes of Operation

*page 87*

### 5 Troubleshooting

*page 96*

### 6 Preventive Maintenance

*page 147*

### 7 Battery Maintenance

*page 161*

### 8 Replacement Procedures

*page 172*

### 9 Assembly Diagrams and Parts Lists

*page 352*

### Table of Contents

Section Navigator .....	ii
Introduction .....	11
Trademarks .....	12
Using Adobe Reader.....	13
Navigating Through the Manual.....	14
Service Personnel Qualifications.....	15
Contacting Physio-Control .....	16
Responsibility for Information .....	17
Device Tracking.....	18
Service Information.....	19
Recycling Information .....	20
Warranty .....	21
Configuration Information .....	22
Glossary.....	23
Acronyms.....	25
Safety.....	29
Terms .....	30
General Warnings.....	31
Symbols.....	36
Device Description .....	48
Introduction .....	49
Physical Description and Features .....	53
Devices, Options, Supplies, and Accessories .....	64
System Context Diagrams .....	69
Functional Descriptions.....	73

Modes of Operation.....	87
Manual Mode .....	88
AED Mode .....	89
Setup Mode.....	90
Service Mode.....	92
Demo Mode.....	94
Archive Mode .....	95
Troubleshooting.....	96
Troubleshooting Chart .....	97
Using the Service/Status Features .....	104
Device Log .....	106
Device Data.....	108
Service Log .....	111
Processing Service Log Codes .....	113
Counters .....	114
Clear Memory .....	116
Service Log Code Categories .....	117
Utility Service Codes .....	118
User Interface Service Codes .....	119
Data Management Service Codes .....	121
System Monitor Service Codes .....	122
Processor Control Service Codes.....	123
ECG Service Codes.....	125
Patient Parameter Service Codes .....	126
Therapy Service Codes.....	127
Printer Service Codes .....	139
Power Management Service Codes.....	140
Corrective Action Codes.....	141

Service LED .....	145
Display Pixels Test .....	146
Preventive Maintenance .....	147
Device Self Tests .....	148
Device User Test .....	149
Preventive Maintenance and Testing Schedule .....	150
Scheduled Replacement Items .....	151
Setting/Resetting the Maintenance Prompt Interval .....	152
Device Useful Life .....	153
Support Policy .....	154
Cleaning .....	155
Environmental Conditions .....	158
A12 Printer Maintenance .....	159
Battery Maintenance .....	161
Battery General Characteristics .....	162
Battery Status Indicators .....	163
Battery Performance Characteristics .....	166
Charging the Batteries Using the Station or Mobile Li-ion Battery Charger .....	167
Discarding/Recycling Batteries .....	168
Storing Batteries .....	169
Receiving New Batteries .....	170
Coin Cell Battery .....	171
Replacement Procedures .....	172
Summary of Replacement Procedures .....	173
Warnings and Cautions .....	176
Static-Sensitive Device Handling .....	177
Tools List .....	179
Capacitor Discharge Tool .....	180

Capacitor Discharging Procedure .....	181
Saving and Restoring the Setup Configuration .....	182
Disassembling the Case .....	183
Reassembling the Case.....	186
Inside Front Case Diagram .....	191
Interface PCB (A05) Replacement.....	192
Backlight PCB (A08) Replacement .....	197
Printer Control Keypad (A09) Replacement .....	200
Main Keypad (A10) Replacement .....	202
Display Shield Replacement .....	204
LCD Display Assembly (A11) Replacement.....	206
Display Lens Replacement.....	209
Front Case Replacement.....	211
System/Interface PCB Cable (W04) Replacement .....	215
Backlight/Interface PCB Cable (W06) Replacement.....	216
Therapy Connector Cable (W11) Replacement .....	217
Printer Control Keypad/Interface PCB Cable (W12) Replacement.....	219
Main Keypad/Interface PCB Cable (W13) Replacement.....	220
Speed Dial Assembly (W15) Replacement: .....	221
Installing the Speed Dial Assembly (W15).....	223
Printer Assembly/Interface PCB Cable (W16) Replacement .....	224
Speaker Assembly (W17) Replacement .....	226
LCD Display Assembly/Interface PCB Cable (W18) Replacement .....	229
Printer Assembly/Chassis Ground Cable (W19) Replacement.....	230
Inside Rear Case Diagrams .....	231
System (A01)/Therapy (A04) PCB Assembly Replacement .....	234
Installing the System (A01)/Therapy (A04) PCB Assembly .....	238
Power PCB (A03) Replacement .....	250

OEM PCB (A06) Replacement.....	261
Energy Storage Capacitor (A15) Replacement .....	268
SpO2 PCB (A16) Replacement.....	271
NIBP (A21)/CO2 (A23) Module Replacement .....	281
EMI Shield Replacement .....	291
NIBP Connector Replacement .....	292
Parameter Bezel Replacement.....	295
Rear Case Replacement.....	301
Handle Replacement.....	307
Paddle Retainer Cover Replacement .....	308
Power/System PCB Cable (W01) Replacement .....	309
Power/Therapy PCB Cable (W02) Replacement .....	310
Power/Contact PCB Cable (W05) Replacement .....	312
ECG Connector Cable (W07) Replacement .....	314
System Connector Cable (W08) and Auxiliary Connector Cable (W09) Replacement .....	317
Battery Pins / Power PCB Cable (W10) Replacement .....	320
USB Flex Module (W14) Replacement .....	325
OEM PCB/SpO2 (W21) Module Cable Replacement .....	327
SpO2 Connector Cable (W22) Replacement.....	329
Therapy to Cap Discharge PCB Wire Harness (W24) Replacement .....	331
OEM PCB/CO2 Module Cable (W26) Replacement .....	332
OEM PCB/NIBP Module Cable (W27) Replacement.....	334
CO2 Inlet Connector Cable (W28) Replacement.....	336
CO2 Adapter Cable (W30) Replacement.....	339
Invasive Pressure Connector Assembly (W33) Replacement.....	341
Temperature Cable Assembly (W35) Replacement.....	343
Contact PCB (A07) Replacement.....	345
Printer Assembly (A12) Replacement.....	346

Coin Battery Replacement .....	348
Battery Pin Replacement .....	350
Software and Device Upgrades .....	351
Assembly Diagrams and Parts Lists.....	352
Section Glossary .....	353
Main Diagrams .....	354
External Parts Diagrams and Lists .....	358
Front Parts Diagrams and Parts List.....	364
System/Therapy PCB Assembly Diagrams and Parts Lists.....	373
Parameter Bezel Diagrams and Parts Lists.....	378
Rear Diagrams and Parts List .....	386
OEM Optional Assemblies, Diagrams and Parts Lists .....	397
Label Language Parts .....	401
LIFEPAK 15 Setup Mode - Instructions.....	430
Connection Diagrams for Assemblies, Control Boards, Cables, and Connectors .....	432
Repair Kits.....	477
Defibrillator Part Number and Serial Number.....	500
Ordering Parts .....	501
Index.....	502



## Introduction

This service manual describes how to maintain, test, troubleshoot, and repair the LIFEPAK 15 monitor/defibrillator (V4 hardware configuration only). Devices with V4 configuration have the V4 icon  on the serial number label. Service instructions for LIFEPAK 15 devices with V1 and V2 hardware configuration are provided in a separate service manual.

Another publication, the *LIFEPAK 15 Monitor/Defibrillator Operating Instructions*, is for use by physicians, clinicians, and emergency care providers. The operating instructions provide step-by-step instructions as well as operator-level testing and maintenance.

**NOTE:** Hyperlinks appear in “[blue text](#).” Text that indicates the name of a button, menu item, or screen message appears in all caps (for example, press ANALYZE, select MANUAL MODE).

This section covers the following topics:

- [Trademarks](#) (p. 12)
- [Using Adobe Reader](#) (p. 13)
- [Navigating Through the Manual](#) (p. 14)
- [Service Personnel Qualifications](#) (p. 15)
- [Contacting Physio-Control](#) (p. 16)
- [Responsibility for Information](#) (p. 17)
- [Device Tracking](#) (p. 18)
- [Service Information](#) (p. 19)
- [Recycling Information](#) (p. 20)
- [Warranty](#) (p. 21)
- [Configuration Information](#) (p. 22)
- [Glossary](#) (p. 23)
- [Acronyms](#) (p. 25)

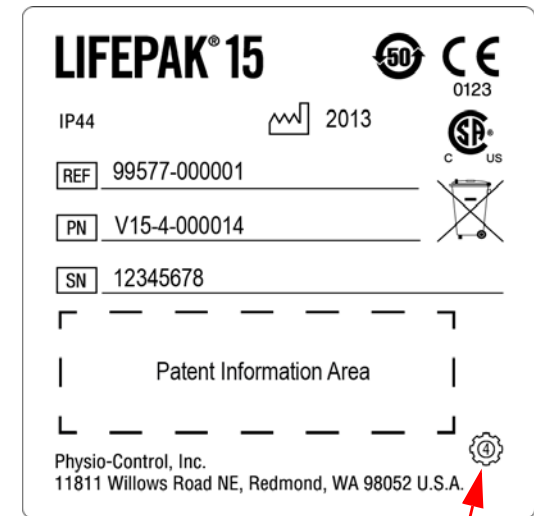

V4 icon

## Trademarks

LIFEPAK, LIFEPAK CR, LIFEPAK EXPRESS, LIFENET, LIFE•PATCH, FAST-PATCH, REDI-CHARGE, and QUIK-COMBO are registered trademarks of Physio-Control, Inc. CODE SUMMARY, CODE-STAT, PARTSLINE, REDI-PAK, Shock Advisory System, SunVue, and DT EXPRESS are trademarks of Physio-Control, Inc. Microsoft and Windows are registered trademarks of Microsoft Corporation in the US and/or other countries. Adobe is a trademark of Adobe Systems Incorporated. Masimo, the Radical logo, Rainbow, and SET are registered trademarks of Masimo Corporation. Red, LNCS, SpCO, and SpMet are trademarks of Masimo Corporation. CapnoLine and FilterLine are registered trademarks of Oridion Medical, Ltd. The Oridion medical capnography in this product is covered by one or more of the following US patents: 6,428,483; 6,997,880; 5,300,859; 6,437,316 and their foreign equivalents. Additional patent applications pending. Fluke and BIO-TEK are registered trademarks and QED-6H is a trademark of Fluke Biomedical Corporation. Bluetooth is a registered trademark of Bluetooth SIG, Inc. CASMED is a registered trademark of CAS Medical Systems, Inc. SIGNAGEL is a registered trademark of Parker Laboratories. EDGE System Technology is a trademark of Ludlow Technical Products. Specifications are subject to change without notice.



© 2019 Physio-Control, Inc.

PN 3316924-004

## Using Adobe Reader

### Accessing Adobe Reader Help

This service manual opens in Adobe® Acrobat Reader. The Adobe Reader can be downloaded for free at the Adobe internet URL <http://www.adobe.com/products/reader.html>. For additional assistance using the Adobe Reader program, access ADOBE READER HELP in the HELP menu.

### Using Bookmarks

Bookmarks appear in a column on the left side of the screen. They enable you to easily navigate to main sections of the manual, similar to a table of contents.

To view or hide the bookmarks column, click the BOOKMARKS tab located along the left side of the screen.



To jump to a bookmark topic, click the desired topic.

**NOTE:** A plus sign to the left of a bookmark topic indicates additional topics exist under that bookmark level. Click the plus sign to expand or collapse the bookmarks.



### Using Page View

Click the PAGES tab located to the far left of the screen to view miniature images of each page in the document. Scroll through the pages and click an image to jump quickly to that page.

## Navigating Through the Manual

Blue text indicates a hyperlink. Click a link to jump to that topic or page. Click  **Back** in the navigation bar (at the bottom of each page) to return to your previous location. The pointer changes to a pointing finger  when positioned over a link. A navigation bar at the bottom of each page also provides helpful links.

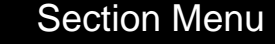
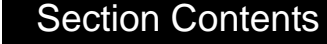
The navigation bar includes:

-  **Section Menu** Click to jump to the main table of contents for the manual.
-  **Section Contents** Click to jump to the table of contents for the section you are currently viewing.
-  **Back** Click to retrace your steps in a document, returning to each page in the reverse order visited.
-  **Index** Click to jump to the manual's index.

## Service Personnel Qualifications

Service technicians must be properly qualified and thoroughly familiar with the operation of the LIFEPAK 15 monitor/defibrillator. They must meet at least one of the following requirements (or the equivalent):

- Associate of Applied Science, with an emphasis in biomedical electronics
- Certificate of Technical Training, with an emphasis in biomedical electronics
- Equivalent biomedical electronics experience

## Contacting Physio-Control

### **Physio-Control, Inc.**

11811 Willows Road NE  
Redmond, WA 98052-2003 USA  
Telephone: 425.867.4000  
Toll Free (USA only): 800.442.1142  
Fax: 425.458.1404

**Internet:** [www.physio-control.com](http://www.physio-control.com)

### **Stryker European Operations B.V.**

Herikerbergweg 110  
1101 CM Amsterdam  
The Netherlands

### **Stryker Australia Pty Ltd**

8 Herbert Street  
St Leonards  
NSW 2065  
Australia

## Responsibility for Information

This service manual describes the methods required to maintain, test, and repair the LIFEPAK 15 monitor/defibrillator. This manual does not address the operation of the device. Qualified service personnel (see [Service Personnel Qualifications on page 15](#)) must consult this manual and the *LIFEPAK 15 Monitor/Defibrillator Operating Instructions* to obtain a complete understanding of the use and maintenance of the device.

It is the responsibility of our customers to ensure that the appropriate person(s) within their organization has access to the information in this service manual, including any warnings and cautions used throughout the manual.

## Device Tracking

### **!USA** Device Tracking:

The U.S. Food and Drug Administration requires defibrillator manufacturers and distributors to track the location of their defibrillators. If the device is located somewhere other than the shipping address or the device has been sold, donated, lost, stolen, exported, destroyed, permanently retired from use, or if the device was not obtained directly from Physio-Control, please do one of the following: register the device at <http://www.physio-control.com>, call the device registration phone line at 1.800.426.4448, or use one of the postage-paid address change cards located in the back of the *LIFEPAK 15 Monitor/Defibrillator Operating Instructions*, to update this vital tracking information.



### Service Information

Before attempting to clean or repair any assembly in the device, the service technician should be familiar with the information provided in [Preventive Maintenance \(p. 147\)](#).

A qualified service technician (see [Service Personnel Qualifications on page 15](#)) should inspect any device that has been dropped, damaged, or abused to verify that the device is operating within performance standards listed in the Performance Inspection Procedures (PIP), and that the leakage current values are acceptable.

Replacement procedures for the device are limited to those items accessible at the final assembly level. Replacements and adjustments must be made by qualified service personnel. Replacements at the final assembly level simplify repair and servicing procedures and help ensure correct device operation and calibration.

To obtain service and maintenance for your device, contact your local Physio-Control service or sales representative. In the USA, call Physio-Control Technical Support at 1.800.442.1142. Outside the USA, contact your local Physio-Control representative. When you call Physio-Control to request service, provide the following information:

- Model number and part number
- Serial number
- Observation of the problem that led to the call

## Recycling Information

Recycle the device at the end of its useful life.

- Recycling assistance – The device should be recycled according to national and local regulations. For instructions on disposing of this product or its accessories, see [www.physio-control.com/recycling](http://www.physio-control.com/recycling).
- Preparation – The device should be clean and contaminant-free prior to being recycled.
- Recycling of disposable electrodes – After using disposable electrodes, follow your local clinical procedures for recycling.
- Recycling of batteries – The device uses rechargeable Lithium-ion batteries. Follow local guidelines and instructions provided in this service manual for discarding and recycling batteries as described in [Discarding/Recycling Batteries \(p. 168\)](#)
- Packaging – packaging should be recycled according to national and local regulations.

## Warranty

To obtain a detailed warranty statement, contact your local Physio-Control representative or go to [www.physio-control.com](http://www.physio-control.com).

Using defibrillation electrodes, adapter devices, or other parts and supplies from sources other than Physio-Control is not recommended. Physio-Control has no information regarding the performance or effectiveness of its LIFEPAK defibrillators if they are used in conjunction with defibrillation electrodes or other parts and supplies from other sources. If device failure is attributable to defibrillation electrodes or other parts or supplies not manufactured by Physio-Control, this may void the warranty.

## Configuration Information

This service manual is relevant for the following device and options:

- LIFEPAK 15 monitor/defibrillator Version 4 (V4) device with auxiliary power option
- ECG monitoring — standard
- Manual mode defibrillation — standard
- AED mode — standard
- Noninvasive pacing — standard
- *Bluetooth*® wireless technology option (within approved countries)
- 12-lead ECG option
- Oridion® CO2 option
- Masimo® SpO2/SpCO™/SpMet™ options
- CASMED® NIBP monitoring option
- 2 Channel Invasive pressure option
- Vital signs and ST trending option
- Temperature monitoring option (temperature option and invasive pressure option cannot be installed on the same device)

## Glossary

The following are definitions of terms used throughout this service manual.

- Biphasic waveform — Characterized by a positive current phase followed by a reverse current phase of shorter duration and decreased magnitude. The waveform pulse characteristic is biphasic truncated exponential (BTE).
- Automated external defibrillator (AED) — An Automated ECG analysis and a prompted treatment protocol for patients in cardiac arrest.
- Shock Advisory System (SAS) — A computerized ECG analysis system used in AED mode for detecting a shockable rhythm. For more information about SAS, see Appendix C in the operating instructions.
- Continuous patient surveillance system (CPSS) — A feature that monitors the patient ECG in LEADS or PADDLES for a potentially shockable rhythm. CPSS is active when the VF/VT ALARM is selected ON (Setup/Alarms) or after pressing the ALARMS button. For more information about CPSS, see Appendix C in the operating instructions.
- CODE SUMMARY™ report — A summary report that includes the ECG segments associated with key events, such as analysis or shock. See “Data Management” in the operating instructions for a sample CODE SUMMARY report.
- CO2 monitor — An optional noninvasive capnometer that monitors CO2, EtCO2, FiCO2, and respiration rate (referred to henceforth as CO2).
- End-tidal carbon dioxide (EtCO2) — EtCO2 is the measurement of CO2 at the end of expiration.
- Event log summary — A report summarizing important events for a particular patient record; part of the CODE SUMMARY report.
- Noninvasive blood pressure (NIBP) — An optional oscillometric measurement of systolic, diastolic, and mean arterial blood pressure, along with pulse rate.
- Noninvasive pacing — A standard feature that delivers repetitive electrical stimuli to the heart through large adhesive electrodes placed on the patient’s chest.

- QUIK-COMBO® pacing/defibrillation/ECG electrodes — An electrode system that allows monitoring of ECG, delivery of pacing and defibrillation therapy to the patient.
- QUIK-COMBO patient simulator — A combination QC therapy cable and ECG lead cardiac rhythm simulator. The simulator is designed for use in training clinical personnel to operate the LIFEPAK 15 monitor/defibrillator.
- Pulse Co-oximeter — An optional noninvasive pulse oximeter that measures the saturation of oxygen in arterial blood, carboxyhemoglobin and methemoglobin concentrations, respectively.
- SpO<sub>2</sub>/SpCO/SpMet — The measure of functional oxygen saturation (SpO<sub>2</sub>), carboxyhemoglobin concentration (SpCO), and methemoglobin concentration (SpMet) in the blood.
- Test Load — An accessory shipped with the LIFEPAK monitor/defibrillator that connects to the QUIK-COMBO therapy cable. It provides a 50 ohm load for shock discharge through the therapy cable.
- Vital sign (VS) and ST segment Trends — An optional trending feature that can graphically display and document a patient's vital signs and ST segment measurements for up to eight hours.

## Acronyms

Table 1.1 lists acronyms and abbreviations used in this manual.

**Table 1.1— Acronyms and Abbreviations**

Term	Description
AAMI	Association for the Advancement of Medical Instrumentation
ADC	Analog-to-digital conversion
AED	Automated external defibrillator
Ah	Ampere hour
AHA	American Heart Association
AMI	Acute myocardial infarction
ANSI	American National Standards Institute
ASIC	Application-specific integrated circuit
BF	Electrically isolated, external body connection
BPM	Beats per minute
BTE	Biphasic truncated exponential
CF	Electrically isolated, direct cardiac connection
CO2	Carbon dioxide

**Table 1.1— Acronyms and Abbreviations (Continued)**

CPR	Cardiopulmonary resuscitation
CPU	Central processing unit
CPSS	Continuous patient surveillance system
DDE	Disposable defibrillation electrodes
DMM	Digital multimeter
DSP	Digital signal processor
DUART	Dual universal asynchronous receiver/transmitter
ECG	Electrocardiogram
EMS	Emergency medical service
ESCC	Energy storage capacitor charger
ESD	Electrostatic discharge
ESU	Electrosurgical unit
EtCO <sub>2</sub>	End-tidal carbon dioxide
FiCO <sub>2</sub>	Inspired carbon dioxide
HR	Heart rate
IEC	International Electrical Commission
IP	Invasive pressure
LCD	Liquid crystal display



**Table 1.1— Acronyms and Abbreviations (Continued)**

LED	Light-emitting diode
Li-ion	Lithium-ion
mmHg	Millimeters of mercury
NIBP	Noninvasive blood pressure
NSR	Normal sinus rhythm
OEM	Original equipment manufacturer
RR	Respiration rate
PC	Personal computer
PCB	Printed circuit board
PIP	Performance inspection procedure
PPM	Pulses per minute
PR	Pulse rate
QRS	Refers to portions of the ECG waveform
RTC/NVRAM	Real-time clock/non-volatile random-access memory
RTS	Radio transparent system
SAS	Shock Advisory System
SBC	Single-Board Computer
SpCO	Measurement of carboxyhemoglobin concentration

**Table 1.1— Acronyms and Abbreviations (Continued)**

SpO <sub>2</sub>	Measurement of oxygen saturation
SpMet	Measurement of methemoglobin concentration
SSD	Static-sensitive device
TCP	Test and calibration procedure
USB	Universal serial bus
VF	Ventricular fibrillation
VS	Vital signs
VT	Ventricular tachycardia
μA	MicroAmpere

## Safety

This section describes the general safety conventions, terms, and symbols used in this service manual or on the LIFEPAK 15 monitor/defibrillator front and rear panels. This information is intended to alert service personnel to recommended precautions in the care, use, and handling of this medical device.

- [Terms \(p. 30\)](#)
- [General Warnings \(p. 31\)](#)
- [Symbols \(p. 36\)](#)

## Terms

The following terms are used in this service manual or on the various configurations of the LIFEPAK 15 monitor/defibrillator (device). Familiarize yourself with their definitions and significance.

### **DANGER**

Immediate hazards that will result in serious personal injury or death.

### **WARNING**

Hazards or unsafe practices that may result in serious personal injury or death.

### **CAUTION**

Hazards or unsafe practices that may result in minor personal injury, product damage, or property damage.

## General Warnings

The following are general danger, warning, and caution statements. Keep them in mind when working with the LIFEPAK 15 monitor/defibrillator (device). Additional specific warnings and cautions appear throughout this service manual and the *LIFEPAK 15 Monitor/Defibrillator Operating Instructions*.

### DANGER

#### EXPLOSION HAZARD

Do not use this defibrillator in the presence of flammable gases or anesthetics.

#### SHOCK HAZARD

Do not disassemble the defibrillator. It contains no operator serviceable components and lethal voltages may be present. Contact authorized service personnel for repair.

### WARNINGS

#### SHOCK OR FIRE HAZARDS

##### SHOCK HAZARD

The defibrillator delivers up to 360 joules of electrical energy. Unless properly used as described in these operating instructions, this electrical energy may cause serious injury or death. Do not attempt to operate this device unless thoroughly familiar with these operating instructions and the function of all controls, indicators, connectors, and accessories.

## WARNINGS (CONTINUED)

### **SHOCK OR FIRE HAZARD**

Do not immerse any portion of this defibrillator in water or other fluids. Avoid spilling any fluids on defibrillator or accessories. Spilled liquids may cause the defibrillator and accessories to perform inaccurately or fail. Do not clean with ketones or other flammable agents. Do not autoclave or sterilize this defibrillator or accessories unless otherwise specified.

### **POSSIBLE FIRE**

Use care when operating this device close to oxygen sources (such as bag-valve-mask devices or ventilator tubing). Turn off gas source or move source away from patient during defibrillation.

### WARNINGS (CONTINUED)

#### ELECTRICAL INTERFERENCE HAZARDS

##### **POSSIBLE ELECTRICAL INTERFERENCE WITH DEVICE PERFORMANCE**

Equipment operating in close proximity may emit strong electromagnetic or radio frequency interference (RFI), which could affect the performance of this device. If use of equipment in close proximity is necessary, observe the device to verify normal operation in the configuration in which the device will be used. RFI may result in distorted ECG, incorrect ECG lead status, failure to detect a shockable rhythm, cessation of pacing, or incorrect vital sign measurements. Avoid operating the device near cauterizers, diathermy equipment, or other portable and mobile RF communications equipment. Do not rapidly key EMS radios on and off. Refer to Appendix D in the Operating Instructions for recommended distances of equipment. Contact Physio-Control Technical Support if assistance is required.

##### **POSSIBLE ELECTRICAL INTERFERENCE**

Using cables, electrodes, or accessories not specified for use with this defibrillator may result in increased emissions or immunity from electromagnetic or radio frequency interference (RFI) which could affect the performance of this defibrillator or of equipment in close proximity. Use only parts and accessories specified in these operating instructions.

### WARNINGS (CONTINUED)

#### **POSSIBLE ELECTRICAL INTERFERENCE**

This defibrillator may cause electromagnetic interference (EMI) especially during charge and energy transfers. EMI may affect the performance of equipment operating in close proximity. Verify the effects of defibrillator discharge on other equipment prior to using the defibrillator in an emergency situation, if possible.

#### IMPROPER DEVICE PERFORMANCE HAZARDS

#### **POSSIBLE IMPROPER DEVICE PERFORMANCE**

Using other manufacturers' cables, electrodes, power adapters, or batteries may cause the device to perform improperly and may invalidate the safety agency certifications. Use only the accessories that are specified in these operating instructions.

#### **POSSIBLE IMPROPER DEVICE PERFORMANCE**

Changing factory default settings will change the behavior of the device. Changes to the default settings must only be made by authorized personnel.

#### POSSIBLE DEVICE SHUTDOWN

Always have immediate access to a spare, fully charged, properly maintained battery. Replace the battery when the device displays a low battery warning.



## WARNINGS (CONTINUED)

### SAFETY RISK AND POSSIBLE EQUIPMENT DAMAGE

#### **POSSIBLE INJURY OR SKIN BURNS**

Monitors, defibrillators, and their accessories (including electrodes and cables) contain ferromagnetic materials. As with all ferromagnetic equipment, these products must not be used in the presence of the high magnetic field created by a Magnetic Resonance Imaging (MRI) device. The high magnetic field created by an MRI device will attract the equipment with a force sufficient to cause death or serious personal injury to persons between the equipment and the MRI device. This magnetic attraction may also damage and affect the performance of the equipment. Skin burns will also occur due to heating of electrically conductive materials such as patient leads and pulse oximeter sensors. Consult the MRI manufacturer for more information.

#### **POSSIBLE SKIN BURNS**

A defect in the neutral electrode connection on HF surgical equipment could cause burns at the lead or sensor site and damage to the monitor/defibrillator. Do not apply patient leads or sensors when using high frequency (HF) surgical (electrocautery) equipment.

## Symbols

The following list includes symbols that may be used in this service manual or on various configurations of the LIFEPAK 15 monitor/defibrillator and accessories. Some symbols may not be relevant to your device or used in every country.

Table 2.1—Symbols







Symbol	Description
Device or User Interface	
	Consult accompanying documents
	Follow instructions for use
	V4 service icon symbol, located on the serial number label. This service manual applies only to LIFEPAK 15 devices with this symbol.
	Alarm on
	Alarm off
	VF/VT alarm on

Table 2.1—Symbols (Continued)









Symbol	Description
	VF/VT alarm is on, but is silenced or suspended
	Battery in well, fully charged. For a description of all battery indicators, see <a href="#">Battery Status Indicators (p. 163)</a> .
	Heart rate/pulse rate indicator
	<i>Bluetooth</i> wireless technology
	Shock count (x) on screen
	Shock button on front panel or hard paddles
	Auxiliary power indicator
	Battery charging indicator
	Service indicator

Table 2.1—Symbols (Continued)







Symbol	Description
>	Greater than
<	Less than
J	Joules
	Display mode button
	Home Screen button
	CO <sub>2</sub> exhaust
	Input/output
	Defibrillation-proof type CF patient connection
	Defibrillation protected, type BF patient connection

Table 2.1—Symbols (Continued)







Symbol	Description
	Do not dispose of this product in the unsorted municipal waste stream. Dispose of this product according to local regulations. See <a href="http://www.physio-control.com/recycling">www.physio-control.com/recycling</a> for instructions on disposing of this product.
	Symbol for China RoHS indicating the Environmentally Friendly Use Period (EFUP) denoting the number of years before any substance is likely to leak out into the environment.
	Mark of conformity to applicable European Directives
	Canadian Standards Association certification for Canada and the United States
	Date of manufacture.
	Authorized EC representative
	Part number
	Serial number

Table 2.1—Symbols (Continued)





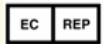



Symbol	Description
	Reorder number
 or Rx Only	By prescription only
	For USA audiences only
	Catalog number
	Manufacturer
 N13571	Indicates that a product complies with applicable ACA standards
	Positive terminal
	Negative terminal
	Fuse

Table 2.1—Symbols (Continued)





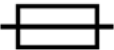

Symbol	Description
	Battery
	Static-sensitive device. Static discharge may cause damage.
Reports	
	Biphasic defibrillation shock
	Pace arrow, noninvasive pacing
	Pace arrow, internal pacing detection
	QRS sense marker
	Event marker

Table 2.1—Symbols (Continued)







Symbol	Description
Accessories	
	Mark of conformity to applicable European Directives
	Recognized component mark for the United States
	Recognized component mark for Canada and the United States
	Complies with (USA) Federal Communications Commission regulations
	Type BF patient connection
	Lot number (batch code). YY (year) and WW (week) of manufacture.
IP44	Enclosure ingress protection code per IEC 60529
	Warning, high voltage



Table 2.1—Symbols (Continued)





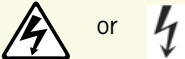



Symbol	Description
	<b>CAUTION - FIRE HAZARD</b> Do not disassemble, heat above 100°C (212°F), or incinerate battery
	<b>CAUTION - FIRE HAZARD</b> Do not crush, puncture, or disassemble battery
	Use By date shown: yyyy-mm-dd or yyyy-mm
	Indoor use only
	Item is latex free
	Lead free
	Dispose of properly
	Store in a cool, dry location (0° to 50°C, 32° to 122°F)
	Single use only

Table 2.1—Symbols (Continued)







Symbol	Description
	2 electrodes in 1 package
	10 packages in 1 shelf-pak
	5 shelf-paks in 1 case
	Shave patient skin
	Clean patient skin
	Treatment
	Tear here
	Press electrode firmly onto patient
	Connect QUIK-COMBO cable

Table 2.1—Symbols (Continued)

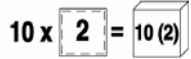
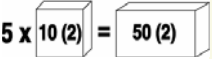







Symbol	Description
	Slowly peel back protective liner on electrode
	Do not use this pediatric QUIK-COMBO electrode on LIFEPAK 500, LIFEPAK 1000, LIFEPAK CR <sup>®</sup> Plus, or LIFEPAK EXPRESS <sup>®</sup> defibrillators
	For use on adults
	Not for use on adults
	For use on children up to 15 kg (33 lb)
	Not for use on children under 15 kg (33 lb)
	Remove label from battery
	Charge battery

Table 2.1—Symbols (Continued)

















Symbol	Description
	Insert battery in LIFEPAK 15 monitor/defibrillator
	Rechargeable battery
	AC-DC power adapter
	DC-DC power adapter
	For use with the LIFEPAK 15 monitor/defibrillator
	Power input
	Power output
	DC voltage
	AC voltage

Table 2.1—Symbols (Continued)

Symbol	Description
Shipping carton	
	This end up
	Fragile/breakable Handle with care
	Protect from water
	Recommended storage temperature -20° to 60°C (-4° to 140°F)
	Relative humidity range 10 to 95%
 or 	Recycle this item

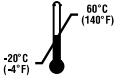
## Device Description

This section describes the physical characteristics and functionality of the LIFEPAK 15 monitor/defibrillator (device). Topics include input signals, assembly functions, and device outputs.

- [Introduction \(p. 49\)](#)
- [Physical Description and Features \(p. 53\)](#)
- [Devices, Options, Supplies, and Accessories \(p. 64\)](#)
- [System Context Diagrams \(p. 69\)](#)
- [Functional Descriptions \(p. 73\)](#)

## Introduction

The introduction provides general information about the LIFEPAK Monitor/Defibrillator including the following topics:

- [About the Device \(p. 49\)](#)
- [Defibrillation Waveform \(p. 49\)](#)
- [Energy Delivery \(p. 49\)](#)
- [Pacing Waveform \(p. 50\)](#)
- [In AED Mode Operation \(p. 50\)](#)
- [Manual Mode Operation \(p. 50\)](#)
- [Device Primary Functions \(p. 50\)](#)
- [Assemblies \(p. 52\)](#)

### About the Device

The LIFEPAK 15 monitor/defibrillator provides innovative solutions for emergency response care, all the way from first responders to throughout the hospital.

### Defibrillation Waveform

The device generates a biphasic truncated exponential (BTE) shock pulse for defibrillation.

### Energy Delivery

The device standard method of defibrillation energy delivery is through self-adhesive QUIK-COMBO pacing/defibrillation/ECG electrodes. When using these disposable electrodes (DDEs), internal circuitry continuously measures the impedance between the electrodes and allows defibrillation only when the defibrillation electrodes are attached to the patient. The user can select from a variety of optional accessories for energy delivery (for example, hard paddles).

### Pacing Waveform

The device generates a Monophasic, truncated exponential current pulse.

### In AED Mode Operation

In the AED mode, see [AED Mode \(p. 89\)](#), the operator is prompted to press ANALYZE, which allows the Shock Advisory System (SAS) to analyze the ECG rhythm and make recommendations. The operator then follows a prompted protocol for administering defibrillation therapy. For more information about AED mode, see section 5 in the operating instructions.

### Manual Mode Operation

In Manual mode, see [Manual Mode \(p. 88\)](#), the LIFEPAK 15 monitor/defibrillator is a direct current defibrillator that applies a brief, intense pulse of electricity to the heart muscle. Manual mode requires operator interpretation of the ECG rhythm and interaction with the device in order to defibrillate the patient. For more information about Manual mode, see section 5 in the operating instructions.

### Device Primary Functions

The device has six primary functions:

- Defibrillation
  - ~ Manual or semi-automatic (AED) defibrillation
  - ~ Leads-off detection for therapy and ECG electrodes
  - ~ Synchronized cardioversion
- Noninvasive pacing
  - ~ Demand and non-demand modes of operation
- Patient information capturing
  - ~ Stores both patient and device data at each event
  - ~ Real-time clock provides time stamps for events



- ~ Provides operator review of stored events for printout or transmission
- ~ Captures up to 360 minutes of continuous ECG data
- ~ Continuous printing of ECG data
- Patient signal monitoring
  - ~ ECG monitoring — displays up to three ECG waveforms simultaneously
  - ~ Pulse oximetry (SpO2) monitoring (continuous numeric and waveform display)  
**NOTE:** SpO2 numeric display will be replaced by SpCO and/or SpMet reading if one or both parameters are above alarm threshold.
  - ~ Heart rate/pulse rate monitoring (continuous numeric display)
  - ~ Noninvasive blood pressure (NIBP) monitoring (numeric display)
  - ~ Invasive pressure (IP) monitoring (continuous numeric and waveform display)
  - ~ Capnography (CO2 and RR) monitoring (continuous numeric and waveform display)
  - ~ Carboxyhemoglobin (SpCO) monitoring (continuous numeric is displayed when parameter is over alarm threshold)  
Note: numeric display will revert to SpO2 reading when alarm condition is canceled.
  - ~ Methemoglobin (SpMet) monitoring (continuous numeric is displayed when parameter is over alarm threshold)  
Note: numeric display will revert to SpO2 reading when alarm condition is canceled.
  - ~ Vital Signs Trend — Vital signs can be displayed graphically for time ranges up to 8 hours.
  - ~ ST Trend — 12-lead ECG ST measurements can be displayed graphically for time ranges up to 8 hours.
  - ~ Temperature monitoring (numeric display).
- 12-lead ECG capture and analysis
  - ~ Acquires, analyzes, and automatically prints 12-lead data
- Alarms and warnings management
  - ~ Ventricular fibrillation/ventricular tachycardia monitoring and alarm
  - ~ Places alarm limits on patient monitoring parameters
  - ~ Automatic alarm limit reset at operator request
  - ~ Activates or suspends alarms and stores alarm events
  - ~ Silences alarms for up to 15 minutes
  - ~ Visual indicators and audible tones in alarm conditions

Service features include calibration and diagnostic functions.

### Assemblies

The device consists of a two-piece case assembly that encloses the following:

Printed Circuit Boards (when fully configured with options)

- A01 System PCB
- A03 Power PCB
- A04 Therapy PCB
- A05 Interface PCB
- A06 OEM PCB
- A07 Contact PCB
- A08 Backlight PCB
- A16 SpO2 Module
- A21 NIBP Module
- A23 CO2 Module

Subassemblies and Wire Harnesses

- A09 Printer Control Keypad
- A10 Main Keypad
- A11 LCD Assembly
- A12 Printer Assembly
- A15 Energy Storage Capacitor
- W07 ECG Connector Cable
- W08 System Connector Cable
- W09 Auxiliary Connector Cable
- W11 Therapy Connector Cable
- W15 Speed Dial Assembly
- W17 Speaker Assembly
- W22 SpO2 Connector Cable
- W28 CO2 Inlet Connector Cable
- W33 Invasive Pressure Cable
- W35 Temperature Cable

See the [Interconnect Diagram \(Figure 9.2 on p. 356\)](#)—shows detailed assembly and cable interconnect information and provides [links to each part diagram. \(p. 354\)](#).

### Physical Description and Features

Refer to this topic for a description and list of features for the following:

- [Front Panel \(p. 54\)](#)
- [Rear Panel \(p. 61\)](#)
- [What Is Shipped with a Basic Device \(p. 63\)](#)

### Front Panel

This section provides information about buttons, indicator LEDs, and connectors on the front panel. Select the area to view on [Figure 3.1 on p. 54](#)

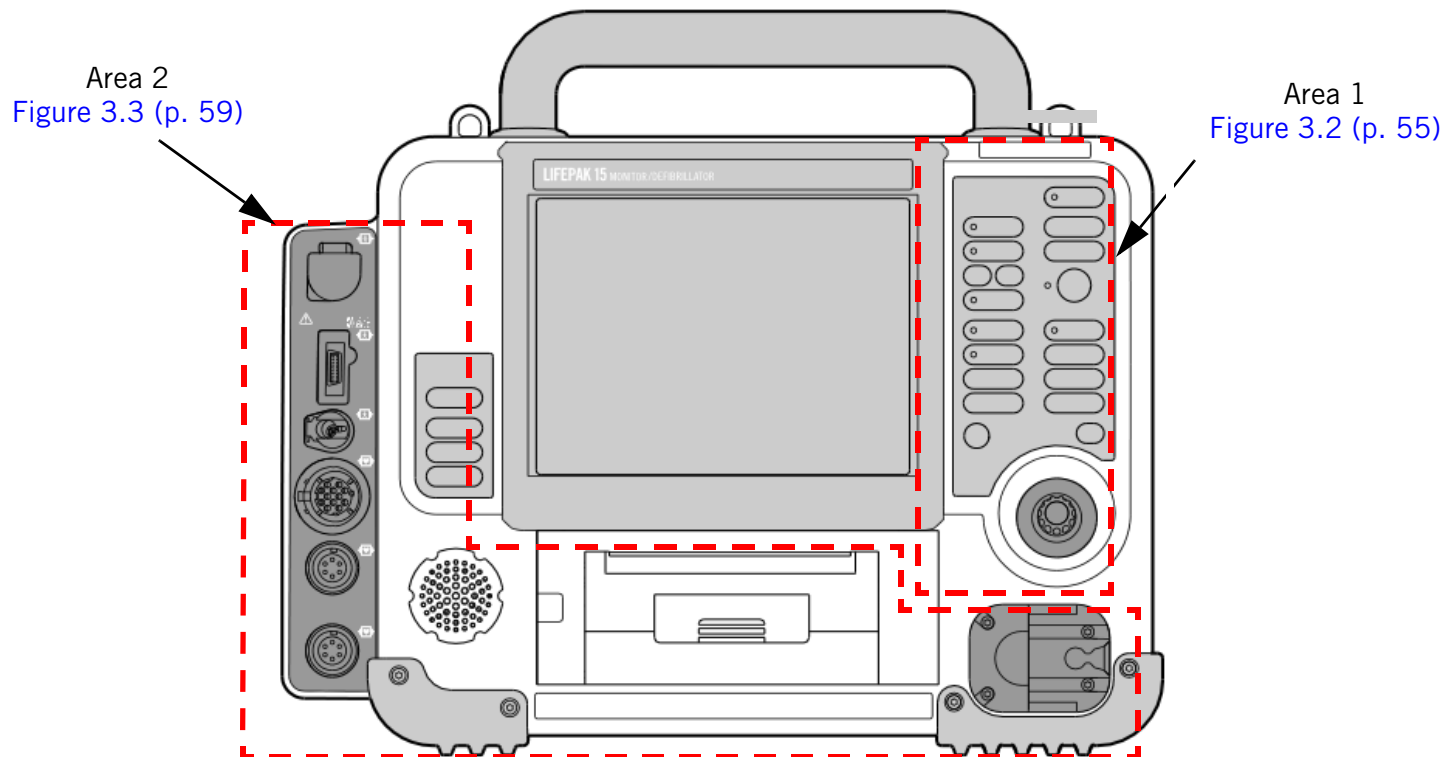

Figure 3.1—Front panel

Click the appropriate number below to view a description of that feature. See area 2 in [Figure 3.3 \(p. 59\)](#).

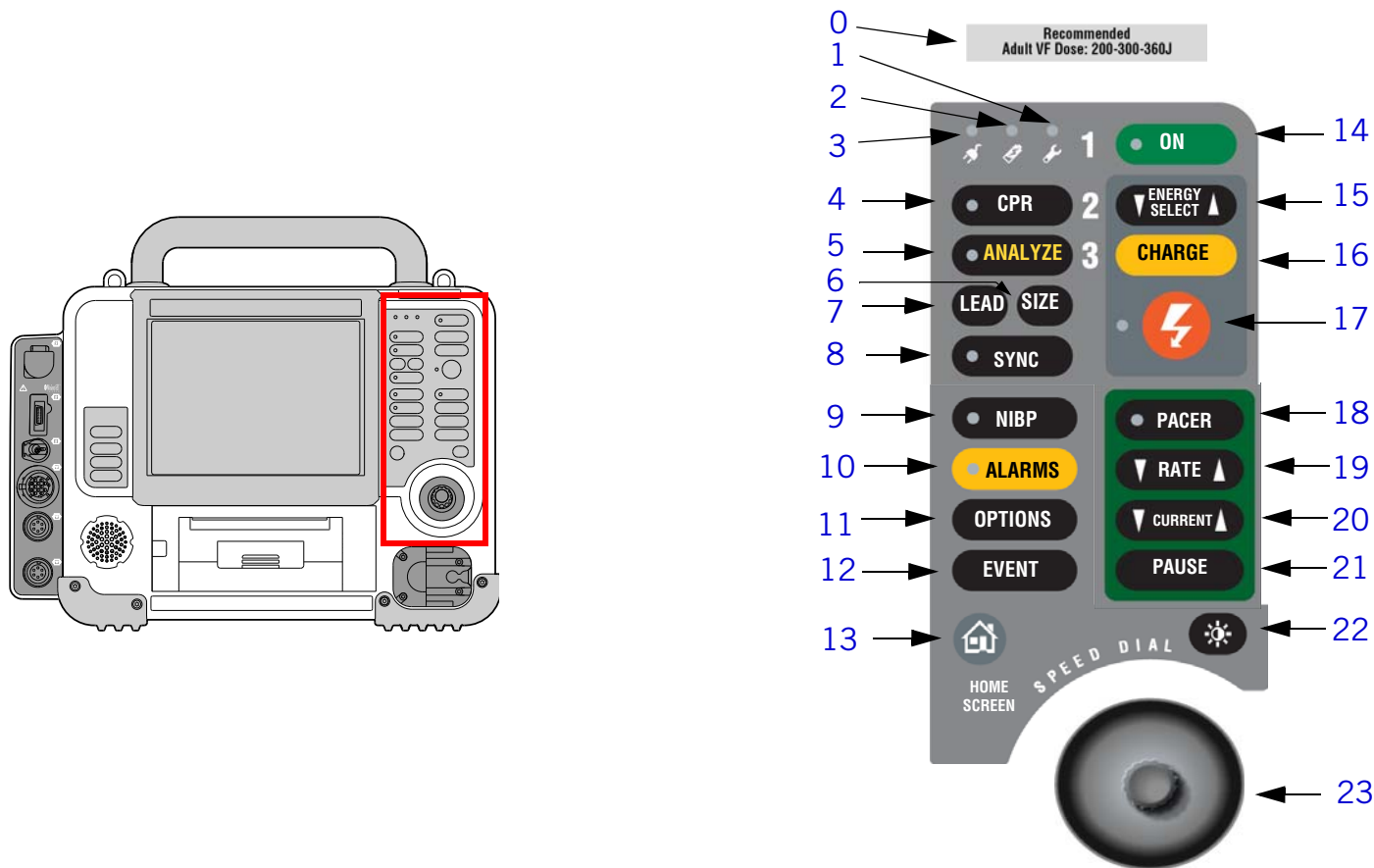

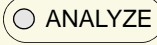

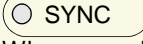
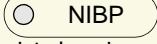
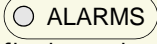

Figure 3.2—Front panel area 1

**Table 3.1— Front Panel Area 1 Features**

Number	Description
0	VF dose label — Physio-Control recommended energy dose for adult Ventricular Fibrillation (VF)
1	 Service LED — Illuminates when service error codes are written into the Service Log (accessed in the Service/Status menu, see <a href="#">Displaying the Service/Status Submenu (p. 104)</a> ). See <a href="#">Troubleshooting (p. 96)</a> for information about error codes.
2	Battery charging indicator — LED illuminated when installed batteries are fully charged. LED flashes when either battery is charging. LED is not illuminated when no batteries are installed or a battery is unable to be charged.
3	Auxiliary power indicator — LED illuminated when defibrillator is connected to auxiliary AC or DC power source, whether defibrillator is turned on or off.
4	 button and LED — Controls CPR metronome. LED is illuminated when metronome function is active.
5	 button and LED — Activates the Shock Advisory System (SAS) in AED mode. The LED is illuminated when the SAS is active and flashes when user is prompted to press ANALYZE.
6	 button — Changes ECG size.
7	 button — Changes ECG lead or lead set.
8	 button and LED — Activates synchronized cardioversion in Manual mode. The LED is illuminated when active. When synchronized, the LED flashes with each detected QRS complex.
9	 button (optional) — Initiates blood pressure measurement. LED is illuminated when BP measurement is being obtained.
10	 button and LED — Open alarms menu or silences alarms. The LED is illuminated when alarms are enabled and flashes when an alarm condition occurs.

**Table 3.1— Front Panel Area 1 Features (Continued)**







Number	Description
11	 button — Accesses optional functions. The options menu selections are: PATIENT, PACING, DATE/TIME, ALARM VOLUME, ARCHIVES, PRINT, and USER TEST.
12	 button — Accesses pre-defined and user-defined events.
13	 <b>HOME SCREEN</b> button — Returns to Home Screen display or to previous menu.
14	 button and LED — Turns device ON or OFF. LED illuminated when ON. Press and hold to turn device off.
15	 button — Increase or decrease defibrillator energy level in Manual mode. Energy levels are from 2 joules to 360 joules.
16	 button — Charges the defibrillator in Manual mode. QUIK-COMBO or hard paddles must be attached. When operating with hard paddles, use the <b>CHARGE</b> button on the <b>APEX</b> paddle. If the device is in pacing mode, pressing this button deactivates Pacing Mode and charges the device.
17	 <b>SHOCK</b> button and LED — Initiates discharge of defibrillator energy in either AED mode or Manual mode. The LED flashes when the device is fully charged. When operated with hard paddles, pressing both <b>SHOCK</b> buttons on the paddles discharge energy.
18	 button and LED — Activates pacer function. LED illuminated when function is activated and flashes with each current pulse.
19	 button — Increases or decreases pacing rate. The up or down arrows on button adjusts the pacing rate in 10 ppm increments, or rotate the <b>SPEED DIAL</b> to change the rate in 5 ppm increments.
20	 button — Increases or decreases pacing current. The up or down arrows on button adjusts the pacing current in 10 mA increments, or rotate the <b>SPEED DIAL</b> to change the current in 5 mA increments.

Table 3.1— Front Panel Area 1 Features (Continued)

Number	Description
21	 button — Temporarily slows pacing rate to 25% of the set rate. While pressed, PAUSED appears before PPM at the bottom of the screen. Release to resume pacing at the set rate.
22	 DISPLAY MODE button — Switches between color display and high contrast SunVue™ display.
23	 SPEED DIAL — Scrolls through and selects screen or menu items.

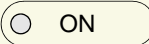
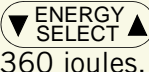

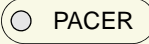
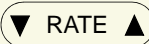
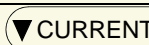
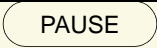
Click the appropriate number to view a description of that feature.

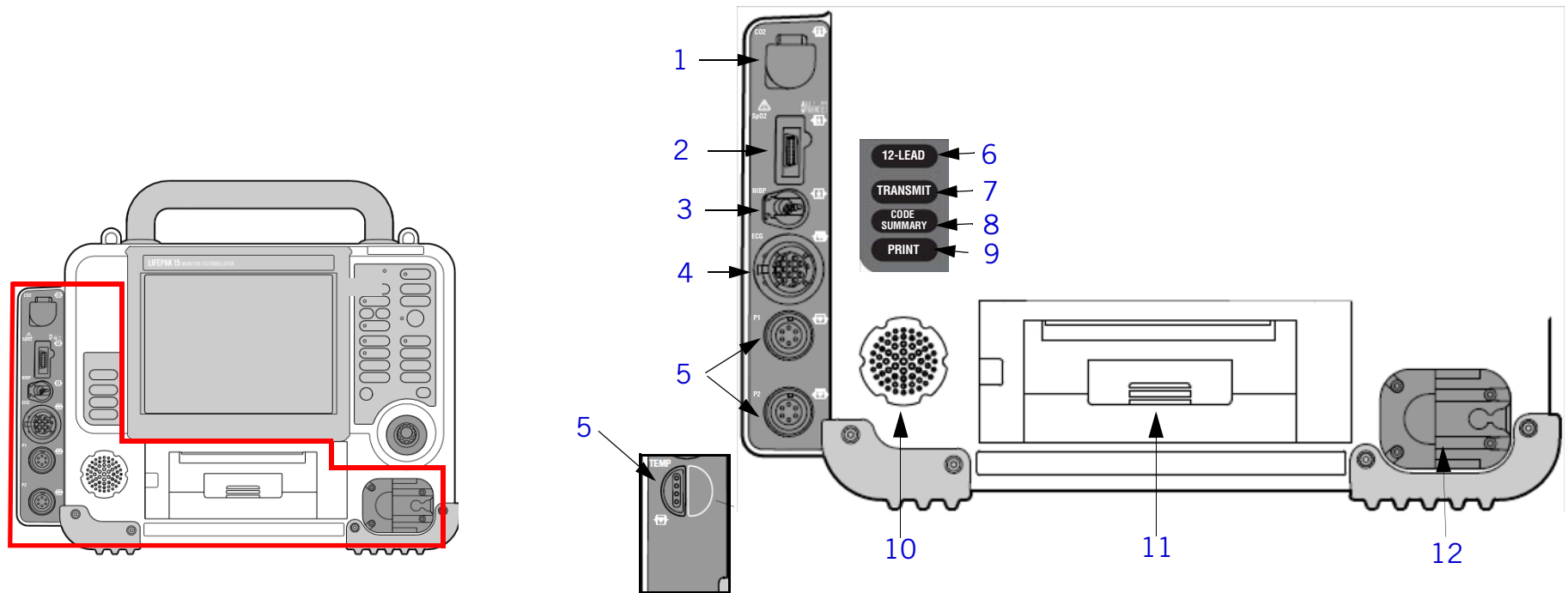
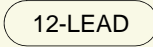
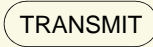



Figure 3.3—Front panel area 2

**Table 3.2— Front Panel Area 2 Features**

Number	Description
1	CO2 FilterLine® set port (optional) — Intake port for the CO2 monitor, which continuously measures the amount of CO2 during each breath and reports the amount present at the end of exhalation (CO2).
2	SpO2/SpCO/SpMet sensor cable port (optional) — Connection port for the pulse oximeter, which noninvasively checks the saturation of oxygen, carboxyhemoglobin concentration, and methemoglobin concentration in arterial blood.
3	NIBP pneumatic tubing port (optional) — Port for connection to the blood pressure tubing which connects to the cuff. NIBP measures the blood pressure of the adult or pediatric patient.
4	ECG cable port — Connection port for the electrically isolated ECG patient cable. Cable configurations include the 12-lead cable with limb lead and precordial lead attachments, 5-wire, and 3-lead cables.
5	IP cable ports — P1 and P2 connection ports for invasive pressure cables, which invasively measure arterial blood pressures, central venous pressure (CVP), or intracranial pressure. Note: If device is configured for temperature monitoring, P1 and P2 are replaced by a single port labeled TEMP.
6	 button (optional) — Initiates acquisition, analysis, storage, and printing of a 12-lead ECG report.
7	 button — Initiates transmission of patient data to another location through direct connect serial, gateway, or wireless connection.
8	 button — Prints a summary of the current patient documentation, including vital signs and waveforms.
9	 button — Prints a continuous ECG stripchart. Press again to stop printing.
10	Speaker — Projects device tones and voice prompts.
11	Printer — Prints displayed waveforms, CODE SUMMARY, and other reports.
12	Therapy cable receptacle — Connection point for QUIK-COMBO therapy cable and hard paddles.

### Rear Panel

This section provides information about features on the rear panel.

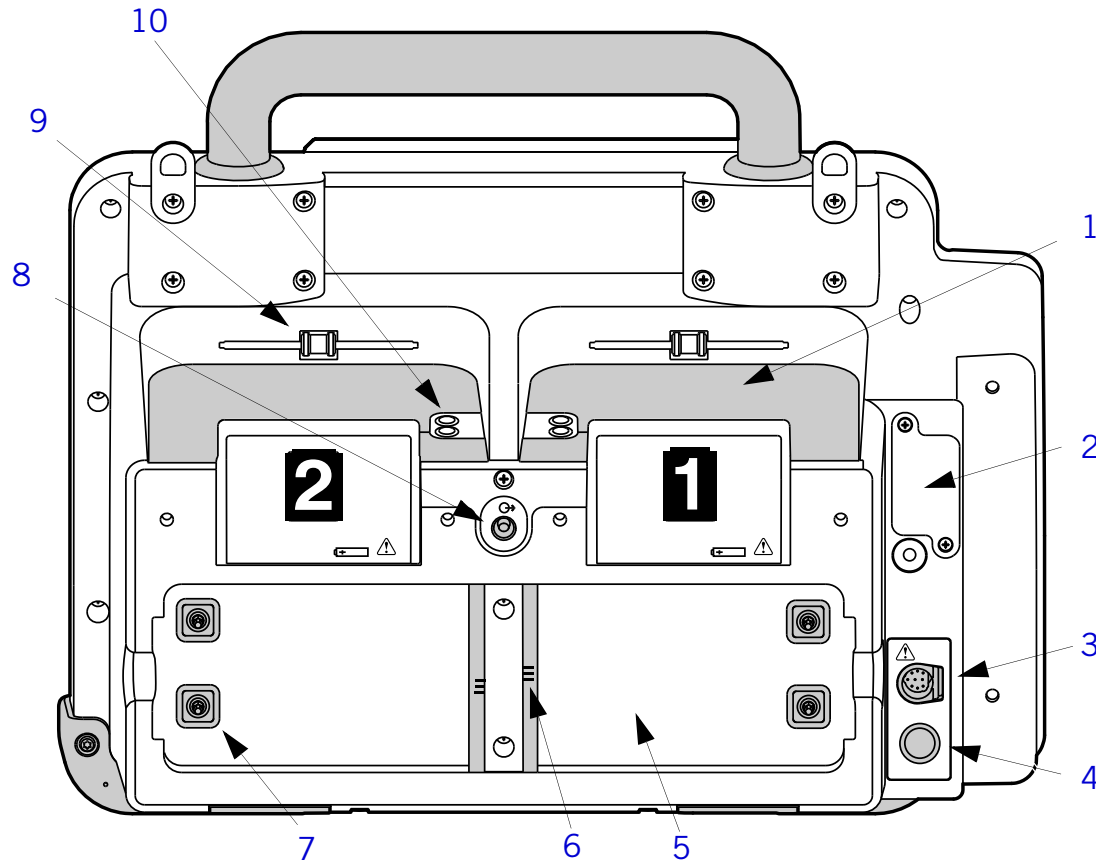

Figure 3.4—Rear features diagram

**Table 3.3— Rear Panel Features**

Number	Description
1	Hard paddle wells — Storage area for a set of hard paddles.
2	USB port cover — Protects USB port from the environment.
3	System connector — Connects device to a gateway or external computer for transfer of patient reports. Also provides real-time ECG output.
4	Auxiliary connector — Connection port for an external power adapter.
5	Battery compartments — Accommodate two removable Lithium-ion batteries that provide power for the LIFEPAK 15 monitor/defibrillator.
6	Battery contacts — Transfer battery status information.
7	Battery pins — Two pins in each battery compartment transfer the battery power.
8	CO2 exhaust port (optional) — Vents gasses from CO2 monitor.
9	Paddle retainers — Provide secure retention and quick removal of paddles.
10	Paddle test contacts — Allow complete paddles defibrillation checks.

### What Is Shipped with a Basic Device

A basic device includes the components shown below.

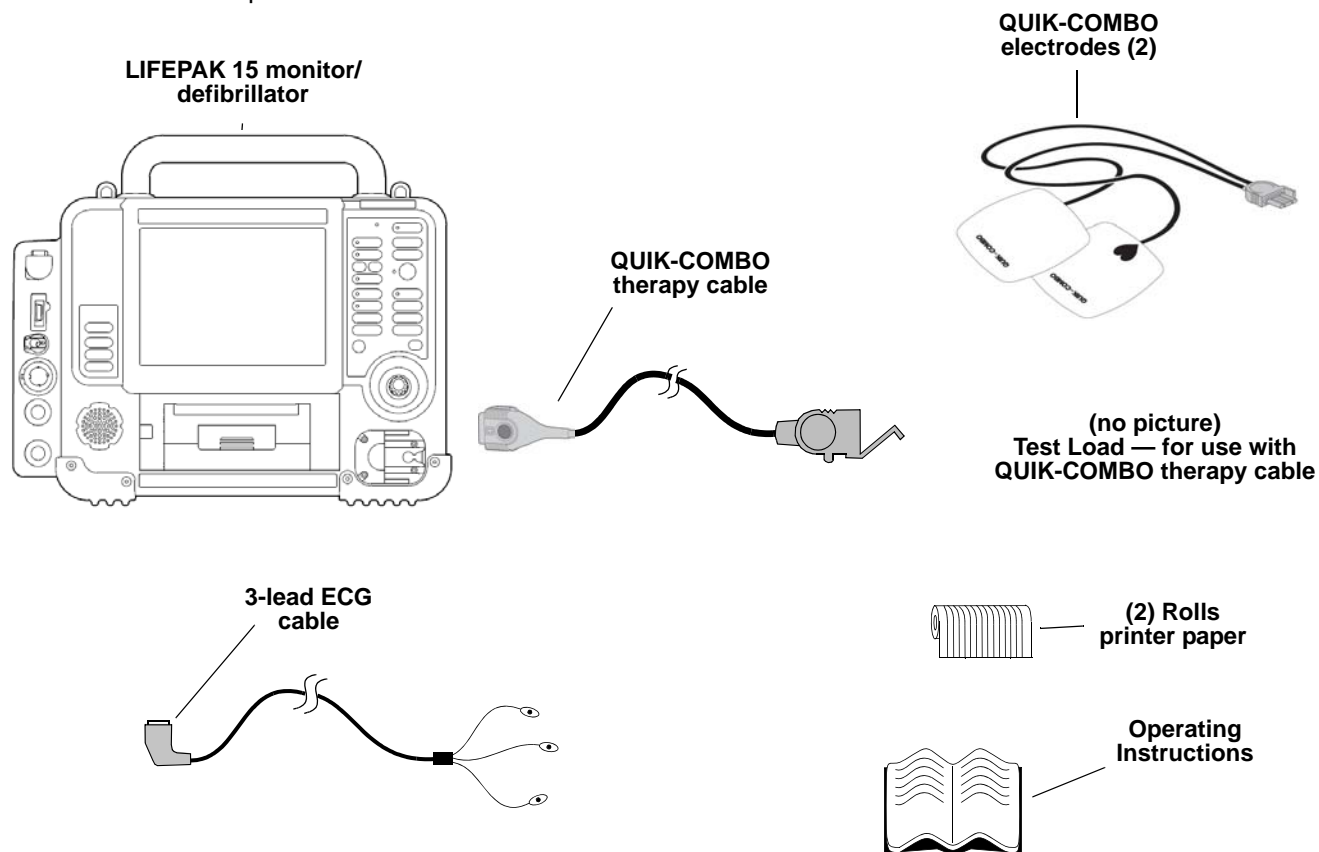

Figure 3.5—Components of the basic device

## Devices, Options, Supplies, and Accessories

The following table, provided for reference, summarizes optional configurations, supplies, and accessories that are available. For up-to-date ordering information, contact your Physio-Control representative or order online at [store.physio-control.com](http://store.physio-control.com) (U.S. only).

**Table 3.4— LIFEPAK 15 Configurations**

Item	Description
<b>LIFEPAK 15 monitor/defibrillator</b>	
Basic device	<ul style="list-style-type: none"> <li>• 3-lead ECG cable</li> <li>• QUIK-COMBO therapy cable</li> <li>• Two sets QUIK-COMBO electrodes</li> <li>• Device operating instructions</li> <li>• 2 rolls of 100-mm printer paper</li> </ul>
<b>Optional Features</b>	
SpO2 (only)	Accessories: <ul style="list-style-type: none"> <li>• Masimo SET® Red™ or LNCS™ sensors</li> <li>• Masimo SET Red patient cables</li> <li>• Nellcor Oximax™ sensors with Masimo Red™ MNC patient cable</li> </ul>
SpO2/SpCO/SpMet	Accessories: <ul style="list-style-type: none"> <li>• Masimo SET Rainbow® sensors</li> </ul>
CO2	Accessories: <ul style="list-style-type: none"> <li>• Airway adapter</li> <li>• FilterLine®</li> <li>• CapnoLine®</li> </ul>

**Table 3.4— LIFEPAK 15 Configurations (Continued)**

Item	Description
NIBP	Accessories: <ul style="list-style-type: none"> <li>• Reusable blood pressure cuff</li> <li>• Disposable blood pressure cuff</li> <li>• NIBP hose - coiled</li> </ul>
Vital signs and ST trending	Provides graphical plot trending of vital signs or ST measurement for up to 8 hours.
Invasive Pressure	See the operating instructions for IP accessory specifications.
Temperature	Accessories: <ul style="list-style-type: none"> <li>• Disposable temperature probes</li> <li>• Temperature probe adapter cable</li> </ul>
12-lead ECG	Accessories: <ul style="list-style-type: none"> <li>• Main 4-wire cable</li> <li>• 6-wire precordial lead attachment</li> </ul>
Bluetooth	Provides wireless communication to Physio-Control data management products
<b>Optional Therapy Delivery</b>	
Hard paddles (can be used instead of QUIK-COMBO cable and electrodes for defibrillation or sync cardioversion)	Pair
Pediatric paddles (attach to hard paddles)	Two required

**Table 3.4— LIFEPAK 15 Configurations (Continued)**

Item	Description
<b>Electrodes</b>	
LIFE•PATCH ECG electrodes (for monitoring only)	Sets of 3 or 4
QUIK-COMBO multifunctional ECG electrodes with EDGE System™ technology	<ul style="list-style-type: none"> <li>• Standard — one pair</li> <li>• Radio transparent system (RTS) — one pair</li> <li>• RTS, pediatric — one pair</li> <li>• REDI-PAK™ preconnect system — one pair</li> </ul>
<b>Power Options</b>	
Batteries (two per device)	<ul style="list-style-type: none"> <li>• Rechargeable Lithium-ion (with fuel gauge)</li> </ul>
LIFEPAK 15 monitor/defibrillator Station or Mobile Li-ion Battery Charger	<ul style="list-style-type: none"> <li>• AC power cord (country/region specific)</li> <li>• DC power cable (Mobile Charger only)</li> <li>• Mounting bracket with 4 (8-32 x 0.5”) screws, 4 lock washers, and template</li> </ul>
REDI-CHARGE® Li-ion Battery Charging System	<ul style="list-style-type: none"> <li>• LIFEPAK 15 Li-ion battery adapter tray</li> <li>• AC power cord (country/region specific)</li> </ul>
LIFEPAK 15 monitor/defibrillator AC power adapter	<ul style="list-style-type: none"> <li>• AC power cord (country/region specific)</li> <li>• Power adapter output cable</li> <li>• Optional - output extension cable</li> </ul>
LIFEPAK 15 monitor/defibrillator DC power adapter	<ul style="list-style-type: none"> <li>• DC power cord (unterminated)</li> <li>• Power adapter output cable</li> <li>• Optional - output extension cable</li> </ul>



**Table 3.4— LIFEPAK 15 Configurations (Continued)**

Item	Description
<b>Data Management and Communications</b>	
Cables	<ul style="list-style-type: none"> <li>• Device-to-PC serial interface cable (connects to serial port on a PC or other equipment)</li> <li>• Device-to-PC USB interface cable (connects to USB connector on a PC or other equipment)</li> <li>• Analog ECG output cable (used to monitor ECG waveforms on external equipment)</li> </ul>
PC software	<ul style="list-style-type: none"> <li>• CODE-STAT™ Reviewer, version 8.0 (minimum version required)</li> <li>• DT EXPRESS™ 3.0 Data Transfer Software</li> </ul>
<b>Training and Testing Tools</b>	
Patient simulators	<ul style="list-style-type: none"> <li>• QUIK-COMBO, 3-lead</li> <li>• QUIK-COMBO, 12-lead (used with 12-lead ECG feature)</li> </ul>
Testers	<ul style="list-style-type: none"> <li>• Defibrillation checker for hard paddles</li> <li>• Test Load — for use with QUIK-COMBO therapy cable only</li> </ul>
<b>Technical Manuals</b>	
Operating Instructions	<ul style="list-style-type: none"> <li>• Printed, one included per device</li> </ul>
Service Manual	<ul style="list-style-type: none"> <li>• CD-ROM</li> </ul>
<b>Carrying Bags</b>	
Carrying bags	<ul style="list-style-type: none"> <li>• Basic carrying bag system — device only (includes left and right bags) with shoulder strap</li> <li>• Shoulder strap</li> <li>• Rear bag — (screws into back of device)</li> <li>• Paddle well bag</li> </ul>

Table 3.4— LIFEPAK 15 Configurations (Continued)

Item	Description
<b>Supplies</b>	
Printer paper	<ul style="list-style-type: none"><li>• 100-mm printer paper — box of 2 rolls</li></ul>
SIGNAGEL <sup>®</sup> electrode gel	<ul style="list-style-type: none"><li>• Use with hard paddles</li></ul>

### System Context Diagrams

Refer to this section to view diagrams of how the major parts of the system are connected. The diagrams include the following:

- [Front of Device \(p. 70\)](#)
- [Device Communication \(p. 72\)](#)

### Front of Device

The following diagrams illustrate how the device connects to external accessories.

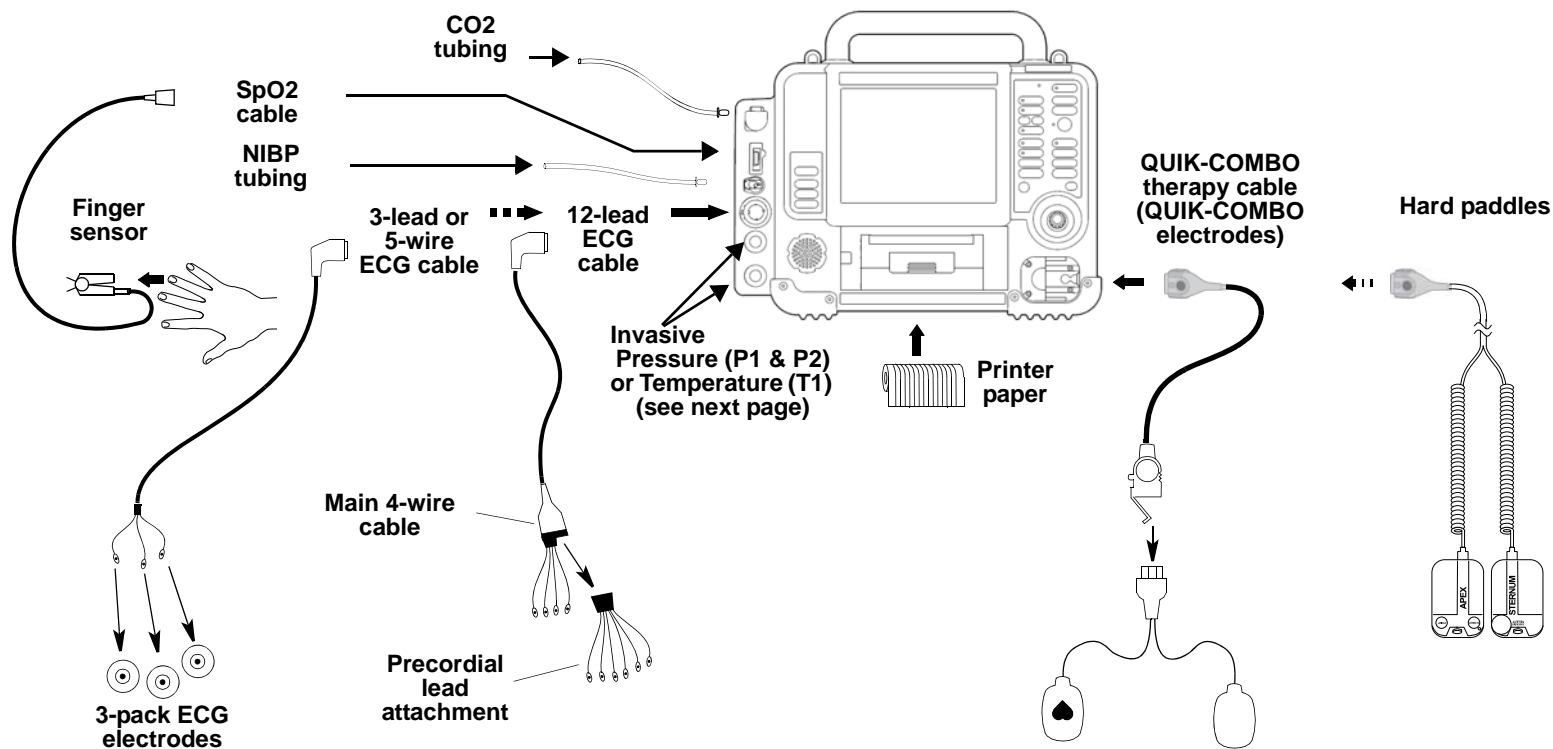

Figure 3.6—Device connections with external equipment and accessories

The following diagram illustrates how the device connects to invasive pressure or temperature equipment.

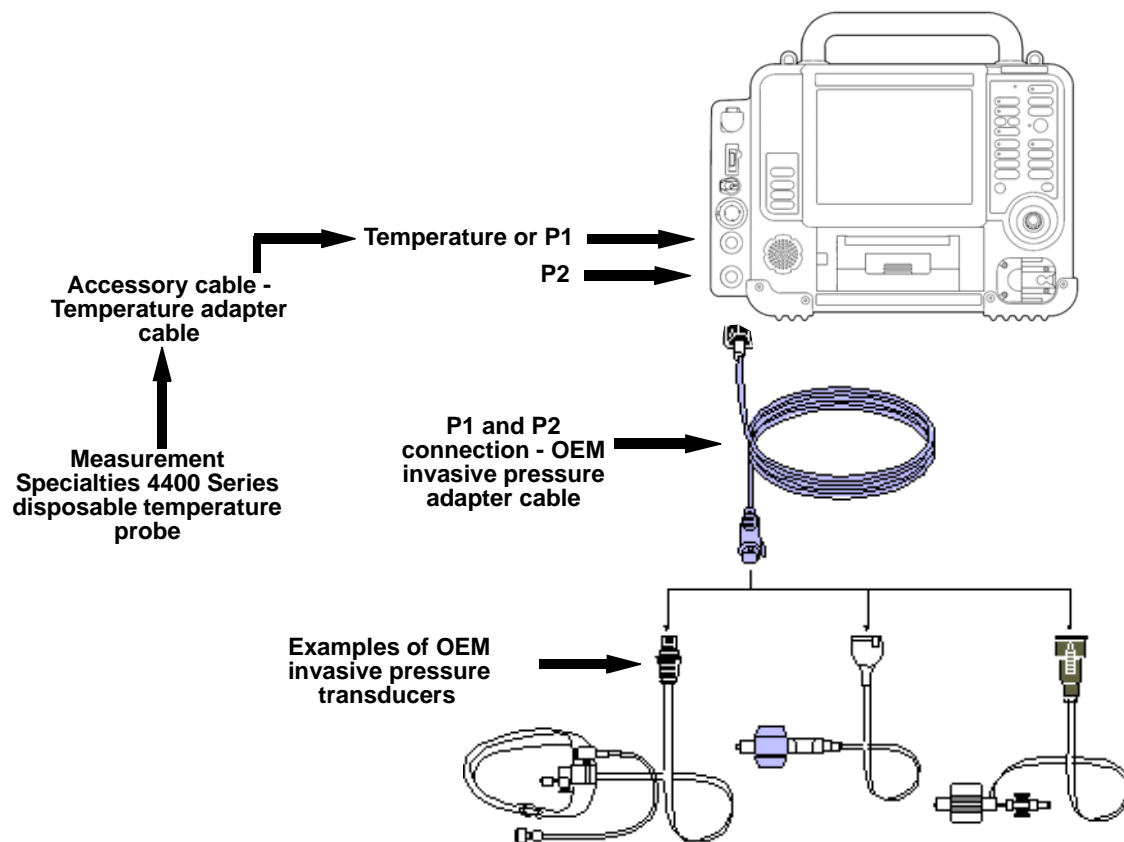

Figure 3.7—Device connection with invasive pressure or temperature equipment

### Device Communication

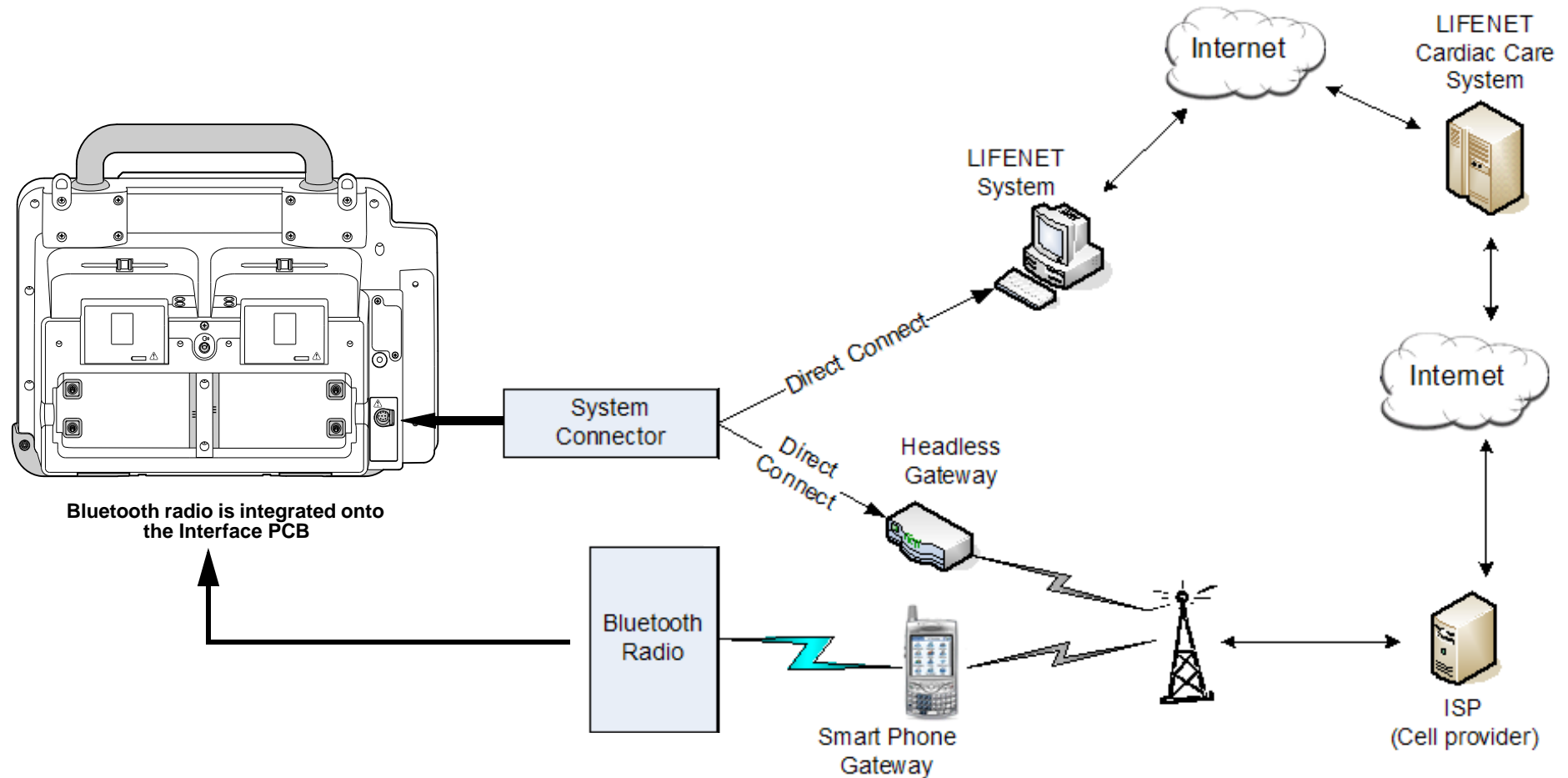

Figure 3.8—Device system connector

## Functional Descriptions

The LIFEPAK 15 monitor/defibrillator (device) is a platform medical device capable of combining a variety of therapeutic and monitoring features. In addition to manual defibrillation, semi-automatic defibrillation, and noninvasive pacing, the device offers optional oximetry, invasive pressure, noninvasive blood pressure, CO<sub>2</sub>, 12-lead ECG, and temperature monitoring. A key feature of the device is its ability to be upgraded as the needs of the customer change or as new features become available. This portable device is powered by two Lithium-ion batteries.

The functional descriptions that follow provide a basic understanding of the device design and assist the qualified service technician in troubleshooting to the subassembly level. Troubleshooting below the subassembly level, outside the factory, is not recommended, nor is it within the scope of this service manual to provide the detail necessary to support such repairs.

See the system block diagram ([Figure 3.9 on p. 75](#)) when necessary as you review the following functional descriptions.

- [System PCB \(A01\) \(p. 76\)](#)
- [Power PCB \(A03\) \(p. 78\)](#)
- [Therapy PCB \(A04\) \(p. 79\)](#)
- [OEM PCB \(A06\) \(p. 82\)](#)
- [Contact PCB \(A07\) \(p. 83\)](#)
- [Backlight PCB \(A08\) \(p. 83\)](#)
- [Printer Control Keypad \(A09\)/Main Keypad \(A10\) \(p. 83\)](#)
- [LCD Assembly \(A11\) \(p. 83\)](#)
- [Printer Assembly \(A12\) \(p. 83\)](#)
- [Energy Storage Capacitor \(A15\) \(p. 84\)](#)
- [SpO<sub>2</sub>/SpCO/SpMet Module \(A16\) \(p. 84\)](#)
- [NIBP Module \(A21\) \(p. 84\)](#)
- [CO<sub>2</sub> Module \(A23\) \(p. 84\)](#)
- [ECG Connector Cable \(W07\) \(p. 84\)](#)
- [System Connector Cable \(W08\) \(p. 85\)](#)
- [Therapy Connector Cable \(W11\) \(p. 85\)](#)
- [Speed Dial Assembly \(W15\) \(p. 85\)](#)

- [Speaker Assembly \(W17\) \(p. 86\)](#)
- [SpO2 Connector Cable \(W22\) \(p. 86\)](#)
- [CO2 Inlet Connector Cable \(W28\) \(p. 86\)](#)
- [IP Connector Cable \(W33\) \(p. 86\)](#)
- [Temperature Connector Cable \(W35\) \(p. 86\)](#)



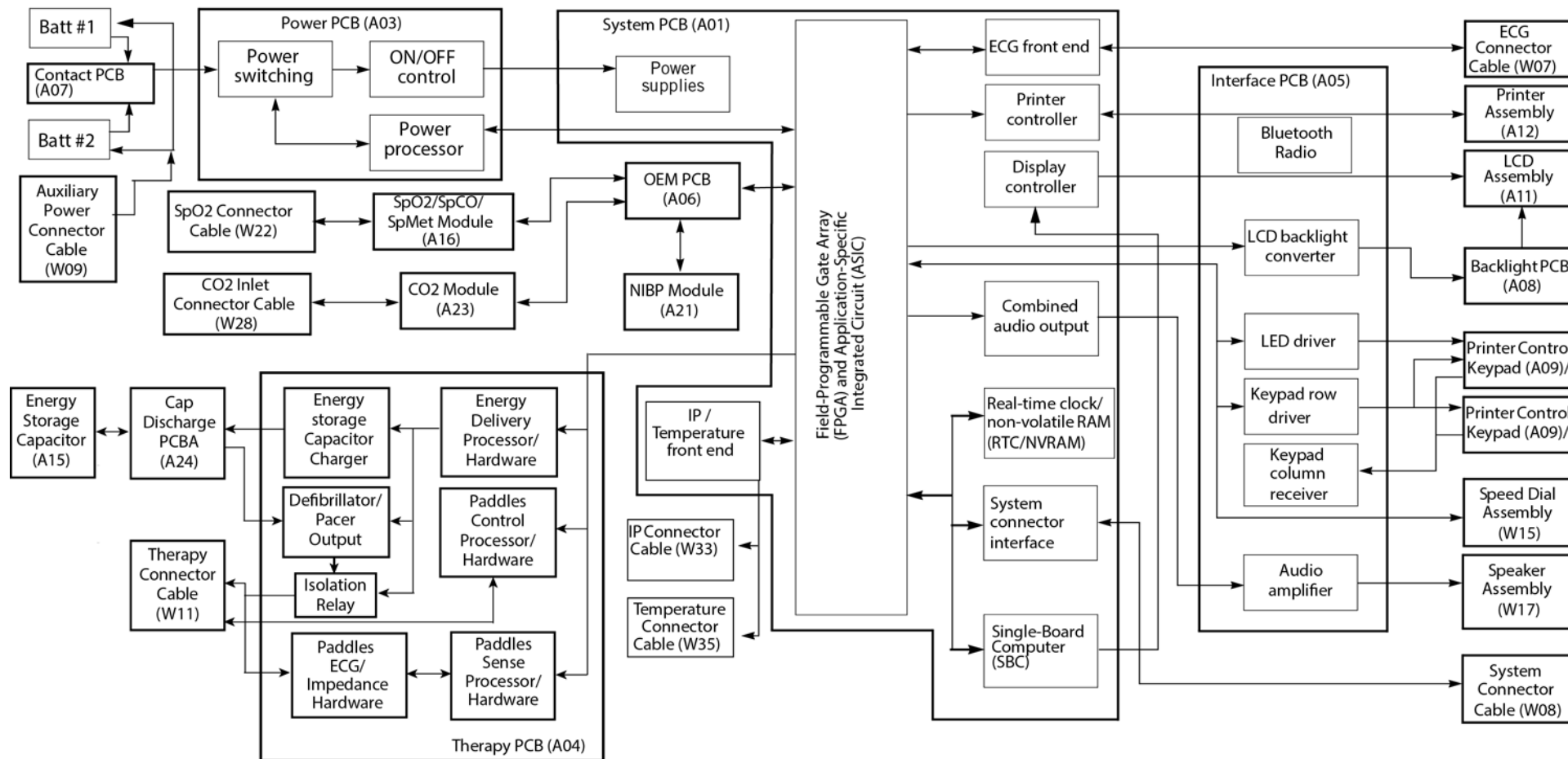

Figure 3.9—System block diagram

### System PCB (A01)

The A01 System PCB integrates and controls all functions of the device. There are two primary components:

#### Single-Board Computer (SBC)

The single board computer (SBC) functions as the central processing unit (CPU) for intensive number-processing tasks.

#### Field-Programmable Gate Array (FPGA) and Application-Specific Integrated Circuit (ASIC)

The field-programmable gate array (FPGA) and application-specific integrated circuit (ASIC) operate as the interface between the CPU and all other therapeutic, monitoring, data management, and display device subsystems.

The following items identify the major subsystems of the A01 System PCB and their basic functions.

#### Power supplies

The A01 System PCB uses SW\_VB (switched battery voltage) from the A03 Power PCB (via the A04 Therapy PCB) to originate six power supplies for use throughout the device as follows:

- ~ +1.5 V power for use on the FPGA.
- ~ +1.8 V power for use on the SBC.
- ~ +5 V logic power for use on the A01 System PCB within the DUART, RTC, ASIC, and audio subsystems, and the A04 Therapy PCB.
- ~ +3.3 V logic power for use on the A01 System PCB within the SBC and FPGA CPUs, DSP, main, and ASIC subsystems.
- ~  $\pm 12$  V analog power for use on the A01 System PCB and A04 Therapy PCB.
- ~ +24 V power for use in the A01 System PCB printer subsystem.

#### ECG front end

The device simultaneously captures inputs from up to 10 independent patient-connected leads for use in the interpretive 12-lead algorithm and ECG waveform display. The ECG front end performs the functions of patient isolation, electrostatic discharge and defibrillation protection, lead selection, baseline dc restore, bandwidth filtering, internal pacemaker

detection, and ECG sampling via analog-to-digital conversion (ADC). Results from the ADC process pass across the isolation barrier to the A01 System PCB digital signal processor (DSP) for filtering and signal conditioning before being used by the SBC CPU. ECG input is through the parameter bezel W07 ECG Connector Cable.

#### IP / Temperature front end

The invasive pressure (IP) circuitry processes the input signal from a disposable IP transducer through the IP input connectors on the device parameter bezel. Two input connectors are provided for simultaneous monitoring of two IP channels. The W33 Invasive Pressure Harness provides the connection from the parameter bezel to the A01 System PCB, where the IP/temp preamplifier circuitry is located.

The IP/temp preamplifier is isolated from the AC power ground by the ECG preamplifier iso-barrier. The transducer drive circuitry supplies a positive 2.5 V and a negative 2.5 V excitation voltage to the resistive bridge-type transducer. The output signal from the transducer is conditioned by a low-pass filter at the input of an instrumentation amplifier, which amplifies the signal approximately 400 times. The signal is then multiplexed to the A-D converter, digitized, and then sent serially across the iso-barrier for DSP processing and display.

The temperature circuitry processes the input signal from a disposable temperature probe through the external adapter cable. The temperature adapter cable connects to the connector below the ECG connector on the parameter bezel. The W35 temperature connector cable provides the connection from the parameter bezel to the A01 System PCB.

#### Printer controller

The device uses a 100-mm thermal array printer. The A01 System PCB printer controller governs motor speed, adjusts print strobe pulse width, senses paper presence and door closure, senses printhead temperature, and provides the data to be printed. Printer fonts are stored in memory devices located on the A01 System PCB.

#### Real-time clock/non-volatile RAM (RTC/NVRAM)

The RTC/NVRAM maintains the date and time and provides storage for device user setups. The RTC/NVRAM is powered by a lithium coin cell battery.

### System connector interface

The device can be connected to external equipment for transmitting analog ECG signal output, data transmission, factory test, Physio-Control field service data collection, and device configuration during field upgrade. Except for analog ECG signals, all data communication at the system connector is at RS-232 levels.

The analog ECG signal output path consists of A01 System PCB components, including a digital-to-analog converter (DAC), low-pass filter, and electrostatic discharge protection.

The digital communications output path consists of the following two components:

- ~ Dual universal asynchronous receiver/transmitter (DUART)
- ~ Level-shifter, used for converting device internal logic levels to RS-232 levels.

### Display controller

Data for display on the device A11 LCD assembly originates from the A01 System PCB Display Controller made up of a portion of the SBC and dedicated data driver/buffers. Screen fonts are stored in memory devices located on the A01 System PCB.

### Combined audio output

Originates from the A01 System PCB ASIC. System audio (voice prompts and alarm tones) from the ASIC returns to analog form in an A01 System PCB DAC. System audio is filtered and routed to the A05 Interface PCB audio amplifier for application to the W17 Speaker Assembly. Voice prompts are stored in memory devices located on the A01 System PCB.

## Power PCB (A03)

The A03 Power PCB manages application of power to the device from the two Li-ion batteries. Additional functions include power on/off control, “smart” battery communication, routing battery charge currents, battery voltage measurement, over-current protection fusing, and serial communication of power status to the A01 System PCB.

A03 Power PCB operation centers around a power processor, which detects the presence of available power sources, selects a power source for use by the device, and monitors their status (for example, low battery, replace battery, removal from the device, etc.) and can apply charging currents from an attached power adapter to the batteries when connected.

When the device is OFF, closure of the device power control activates A03 Power PCB circuitry to alert the power processor, which chooses the appropriate source to originate SW\_VB (switched battery voltage) power. SW\_VB is then routed, in turn, to the A04 Therapy PCB and A01 System PCB for use, as is, and for further processing into system power supply voltages.

Closure of the power control when the device is ON triggers an orderly device shutdown prior to turning off SW\_VB.

### Therapy PCB (A04)

The A04 Therapy PCB maintains the patient interface for therapeutic purposes. In addition to developing biphasic defibrillation and noninvasive pacing energies, the A04 Therapy PCB ensures safe delivery of those energies, captures ECG paddles, and monitors attachment of accessory therapy delivery cables, such as the QUIK-COMBO cable. There are three processing systems on the A04 Therapy PCB: the Energy delivery processor, Paddles sense processor and Paddles control processor.

The major subsystems of the A04 Therapy PCB and their basic functions are as follows:

#### Energy delivery processor

The energy delivery processor manages the defibrillator and pacemaking energy storage and delivery functions using serial inputs from the A01 System PCB FPGA, hardware inputs from external paddles, and inputs from other A04 Therapy PCB circuitry and processors. Status of the defibrillator subsystem is reported serially to the A01 System PCB FPGA.

#### Paddles sense processor

The paddles sense processor controls ECG, leads off detection, impedance and motion detection.

#### Paddles control processor

The paddles control processor is responsible for identification of therapy cables connected to W11 Therapy cable connector.

#### Energy storage capacitor charger (ESCC)

Under control of the energy delivery processor, the ESCC converts SW\_VBAT (common battery voltage) to high voltage for application to the energy storage capacitor. Circuitry within the ESCC performs comparisons between stored energy and target

energy to limit charging to the value selected by the user.

#### Defibrillator energy transfer control

To enable the transfer of defibrillation energy, the A04 Therapy PCB integrates control signals from the SHOCK button (or external paddles' SHOCK buttons) via the energy delivery processor and the A01 System PCB, system processor. The transfer relay will be activated to deliver energy to the defibrillation electrodes only when all conditions are satisfied in each system component. During noninvasive pacemaker operation, the transfer relay remains closed, allowing energy to pass to the defibrillator/pacing electrode pads.

#### Defibrillator energy dump relay control

The dump relay control is a fail-safe system used to safely dissipate defibrillation energies from the energy storage capacitor under a number of circumstances (for example, change of energy selection, power removal, pacing activation, and QUIK-COMBO leads-off). The dump relay control system functions under the control of the system and/or energy delivery processors.

#### QUIK-COMBO leads-off (impedance sense/motion detection)

With the QUIK-COMBO electrodes applied and the device in AED mode, leads-off/motion detection circuits are active. Only leads-off is active when device is in Manual mode and QUIK-COMBO electrodes applied.

For purposes of this discussion, consider the leads-off/motion detector and patient system as a simple voltage divider.

Leads-off/motion detection relies on two main characteristics:

- ~ Leads-off/motion detector output impedance is relatively high (greater than 125 k $\Omega$ ).
- ~ Patient impedance is relatively low (typically less than 30  $\Omega$ ).

To exploit these characteristics, the device injects an ac impedance drive signal through the QUIK-COMBO electrodes into the relatively low patient impedance and monitors the voltage drop across the patient. Minute perturbations sensed in the low-amplitude signal developed across the patient represent motion; gross changes in the sensed signal indicate electrode disconnection.

#### Paddles/QUIK-COMBO ECG preamplifier

The ECG paddles/QUIK-COMBO ECG preamplifier perform the functions of patient isolation, electrostatic discharge and defibrillation protection, baseline dc restore, bandwidth filtering, and ECG sampling through analog-to-digital conversion (ADC). Results from the ADC process are fed to the energy delivery processor, paddles sense processor, and paddles control processor.

#### Noninvasive pacemaker

The A04 Therapy PCB noninvasive pacemaker subsystem develops isolated, adjustable current, 20-millisecond (nominal), trapezoidal transchest pacing impulses. Major components of the noninvasive pacemaker include the energy delivery processor, isolated low- and high-voltage power supplies, safety monitors, output current, pulse width, and pulse shape controls. Controls for, and status of, the noninvasive pacemaker passes between the energy delivery processor and the A01 System PCB FPGA. When the pacemaker is active, the transfer relay control is closed, allowing the energy to be passed to therapy electrode pads.

### Interface PCB (A05)

The A05 Interface PCB is primarily a signal collector/distributor used to simplify the routing of cables between the front and rear halves of the device. The majority of signals from the device rear half are consolidated into the W04 System PCB/Interface PCB Cable and passed to the A05 Interface PCB for further distribution to front half components (for example, A09 Printer Control Keypad, A10 Main Keypad, A11 LCD Assembly, and A12 Printer Assembly). The following active circuits reside on the A05 Interface PCB:

#### Audio amplifier

Combined audio output signals receive final amplification in the A05 Interface PCB Audio Amplifier prior to application to the W17 Speaker Assembly.

#### LED driver

Most device LEDs (located on the A10 main keypad) receive their drive from a serial-to-parallel converter located on the A05 Interface PCB. The Service LED drive originates from the A01 System PCB ASIC. The CHARGE and Power ON LEDs receive their drive from the A03 Power PCB Power Processor.

#### Keypad row driver

The A01 System PCB ASIC reads device control buttons using a row and column address scheme (that is, each button resides at a unique row and column address). Data from the ASIC shifts serially into the A05 Interface PCB Keypad Row Driver (a serial-to-parallel converter) for application to button rows in the A09 printer control keypad and A10 main keypad. A button closure enables row drive for a unique button to be sensed at the keypad column receiver.

#### Keypad column receiver

The A01 System PCB ASIC reads button closures serially from the Interface keypad column receiver (a parallel-to-serial converter). In practice, closure of a device button passes row drive for that button to one, and only one, column receiver input.

#### LCD backlight converter

The A05 Interface PCB applies filtered SW\_VB through a Boost Converter to apply a minimum of 9.6 V to the A08 Backlight PCB when it receives an enable signal (LCD\_BL\_ON) from the A01 System PCB display controller. A separate backlight power supply is mounted on a metal bracket in the front case.

#### Bluetooth Radio

Bluetooth radio is integrated onto the Interface PCB. You can transmit current and archived data from the LIFEPAK 15 device to the LIFENET® System or to post-event review products such as CODE-STAT™ or DT EXPRESS™ software.

### OEM PCB (A06)

A PCB used to integrate monitoring modes supplied to Physio-Control by third parties, or original equipment manufacturers (OEMs), into the device system architecture. The A06 OEM PCB provides isolated power supplies, safety isolation, transient protection, and signal interface adapters to support hosted OEM modules.



### Contact PCB (A07)

Interfaces the Li-ion battery edge connector with the device and provides I2C communication to and from the battery. In addition, the device uses a battery pull signal to indicate when the battery is being removed.

### Backlight PCB (A08)

A printed circuit board that contains the circuitry to light the A11 LCD assembly screen.

### Printer Control Keypad (A09)/Main Keypad (A10)

Common device controls (those not available using the **SPEED DIAL**) are initiated through either the A09 printer control keypad or the A10 main keypad. The number of buttons on these keypads varies, depending on the features installed in a specific device. All buttons, with the exception of **ON** and **SHOCK**, are addressed by the user controls section of the A01 System PCB ASIC.

- The **ON** button remains separate from the addressed buttons because it is needed to activate and deactivate the device without ASIC interaction. Closures of the **ON** button are applied to the A03 Power PCB On/Off control block.
- The **SHOCK** button remains separate from the addressed buttons as a matter of fail-safe design, thus preventing inappropriate activation under conditions of loss of CPU control. Operator-initiated closures of the **SHOCK** button are applied to the FPGA and controlled by the system processor.

### LCD Assembly (A11)

A backlit, 640 × 480 pixel, color LCD that displays the primary and secondary ECG waveforms and text messages.

### Printer Assembly (A12)

The 100-mm printer is installed to support 12-lead ECG monitoring and printing of multiple displayed waveforms.

### Energy Storage Capacitor (A15)

A metallized film capacitor used for energy storage. The capacitance of the A15 Energy Storage Capacitor is calculated when you perform the TCP – Defibrillator Calibration procedure. The nominal value is 196  $\mu$ F.

### SpO2/SpCO/SpMet Module (A16)

An OEM oximetry module supplied by Masimo. The module performs all functions related to oxygen, carboxyhemoglobin and methemoglobin saturation, including sensor drive. Measurement results pass serially by means of the A06 OEM PCB to the A01 System PCB ASIC for display.

### NIBP Module (A21)

An OEM NIBP monitor supplied by CAS Medical Systems. This module performs blood pressure monitoring, determining systolic, diastolic and mean pressures and pulse rate. Measurement results pass serially by means of the A06 OEM PCB to the A01 System PCB ASIC for display. Readings may be taken one time or on a recurring interval.

### CO2 Module (A23)

An OEM capnometry module supplied by Oridion Medical Ltd. This module continuously monitors end-tidal carbon dioxide (CO2) and respiratory rate. Measurement results pass serially by means of the A06 OEM PCB to the A01 System PCB ASIC for display.

### ECG Connector Cable (W07)

A front panel connector port used for attaching a 3-lead, 5-wire, or 12-lead ECG cable. Signal processing takes place on the A01 System PCB ECG front end processing circuitry (see [ECG front end \(p. 76\)](#)).

### System Connector Cable (W08)

A rear panel connector port used for the exchange of digital information with an external modem, personal computer, factory test systems, or Physio-Control field service test systems. The system connector also supplies a real-time analog ECG signal for use in basic central monitoring or telemetry systems.

### Auxiliary Power Connector Cable (W09)

A rear panel access port used for connection of external power adapters.

### Therapy Connector Cable (W11)

A patient connector port used for delivery of either defibrillation or pacing therapeutic energies. The therapy connector allows attachment of all available electrode accessories, including QUIK-COMBO pacing/defibrillation/ECG electrodes, and adult hard paddles with energy select and discharge control.

**NOTE:** Some therapeutic accessories such as pediatric or posterior paddle attachments connect to the device by means of the accessories mentioned previously.

The LIFEPAK 15 monitor/defibrillator uses varying jumper configurations within attached accessories to determine the type of accessory connected. Discriminator circuitry within the A04 Therapy PCB defibrillator processor subsystem decodes the accessory jumper configurations.

### Speed Dial Assembly (W15)

A rotary, optical pulse-code modulator used to navigate through and select specific items from the LIFEPAK 15 monitor/defibrillator menu system. Detent points on the **SPEED DIAL** provide tactile feedback to the user. When the desired item has been highlighted on the display, the user presses the **SPEED DIAL** to enter the selection. The **SPEED DIAL** forms part of the user controls and indicators block. Pulses derived from the W15 speed dial assembly pass serially to the user controls portion of A01 System PCB ASIC.

### **Speaker Assembly (W17)**

Used to announce device warnings, alarms, tones and, in AED mode, voice prompts. Drive for the W17 Speaker Assembly originates in the A01 System PCB combined audio output block. Final amplification occurs in the A05 Interface PCB audio amplifier.

### **SpO2 Connector Cable (W22)**

A front panel connector port on the parameter bezel used for attaching an SpO2 (oximeter) sensor.

### **CO2 Inlet Connector Cable (W28)**

A front panel connector port used for attaching a CO2 FilterLine®. Signal processing takes place on the CO2 module.

### **IP Connector Cable (W33)**

A front panel connector port used for attaching invasive pressure transducers.

### **Temperature Connector Cable (W35)**

A front panel connector port used for attaching external temperature probes.

## Modes of Operation

When the LIFEPAK 15 monitor/defibrillator is turned on, it is always in one of six modes of operation. See the following topics to learn more about a particular mode.

- [Manual Mode \(p. 88\)](#)—for performing manual defibrillation, synchronized cardioversion, noninvasive pacing, and ECG and vital sign monitoring.
- [AED Mode \(p. 89\)](#)—for automated ECG analysis and a prompted treatment protocol for patients in cardiac arrest.
- [Setup Mode \(p. 90\)](#)—for changing default settings of the operating functions. For additional information, see *LIFEPAK 15 Monitor/Defibrillator Setup Options* (REF 26500-003308).
- [Service Mode \(p. 92\)](#)—for authorized personnel to perform diagnostic tests and calibrations.
- [Demo Mode \(p. 94\)](#)—for simulated waveforms and trend graphs for demonstration purposes.
- [Archive Mode \(p. 95\)](#)—for accessing stored patient information.

## Manual Mode

### Entering Manual Mode

To enter Manual mode, turn on the device. The factory default settings allow direct access to Manual mode. This access can be modified to require confirmation or a passcode, or can be restricted entirely.

- ◆ To change Manual mode access:
  1. Select MANUAL MODE in the Setup menu (see [Setup Mode \(p. 90\)](#)).
  2. In the Setup/Manual Mode submenu, select MANUAL ACCESS.

**Table 4.1— Mode Response Descriptions**

Mode/Response When Turned On	Response Description
Manual/Direct (default)	Turn on in Manual; direct access between AED and Manual modes
AED/Direct	Turn on in AED; direct access between AED and Manual modes
AED/Confirm Once	Turn on in AED; operator confirms Manual mode selection once
AED/Confirm Always	Turn on in AED; operator confirms Manual mode selection every time
AED/Passcode Once	Turn on in AED; operator enters Manual mode passcode once
AED/Passcode Always	Turn on in AED; operator enters Manual mode passcode every time
AED/Restricted	Turn on in AED; no access to Manual mode

## AED Mode

### About AED Mode and Entering AED Mode

Factory default settings allow the device to operate in Manual mode. If you want the device to operate in AED (automated external defibrillator) mode when it is turned on, you must change several setup options in different menus. The Setup/AED Mode menu allows you to change settings for the AED prompted protocol.

- ◆ To set up the device to turn on in AED mode:
  1. Select MANUAL MODE in the Setup menu (see [Setup Mode \(p. 90\)](#)).
  2. In the Setup/Manual Mode submenu, select MANUAL ACCESS.
  3. Select the desired AED/XXX option.
  4. Press HOME SCREEN.
  5. Select MONITORING and then select CHANNELS.
  6. Select SET 1 and then select CHANNEL 1.
  7. Select PADDLES.
  8. Select PREVIOUS PAGE. Confirm that Set 1 appears as the Default Set.

## Setup Mode

### About Setup Mode

Setup mode allows you to change the factory default settings and define custom settings based on local medical protocols and specific needs. Options include general characteristics, manual and AED mode operating characteristics, alarms setup, transmission sites, time-of-day clock, and other options. There is also a factory reset option that resets the device to the factory default settings, (except for transmission menu entries and the maintenance interval, which remain unchanged). When setup is complete, turn off the device to save the settings. The next time the device is turned on, the operating defaults you selected are active.

### Preserving the Existing Setup Options

Print the existing device setup options by selecting Print Defaults from the Setup mode menu or store setup options using the LIFEPAK Defibrillator Software Solutions Configuration Setup Tool before performing service.

**NOTE:** The LIFEPAK Defibrillator Software Solutions Configuration Setup Tool is a Windows<sup>®</sup>-based application designed to assist you in managing the setup options in your LIFEPAK 15 monitor/defibrillator. You can download the tool from <http://www.physio-control.com/config.aspx>.



### Entering Setup Mode

- ◆ To enter the Setup mode:
  1. Press and hold **OPTIONS** and **EVENT**, and then turn the device **ON**. Continue holding until the Setup mode passcode prompt appears. The factory default passcode is 0000; the reserved technician passcode is 5433.
  2. To enter the passcode, rotate the **SPEED DIAL** to select a digit, and then press the **SPEED DIAL** to continue. After the last digit is entered, the Setup menu appears.
  3. Rotate the **SPEED DIAL** to select a setup option, and then press the **SPEED DIAL** to display the option submenu.

For more detailed information about Setup mode options, see *LIFEPAK 15 Monitor/Defibrillator Setup Options* (Example, 26500-003308. See [Table 9.15 Setup Mode - Instruction Catalog Numbers](#) (p. 430))

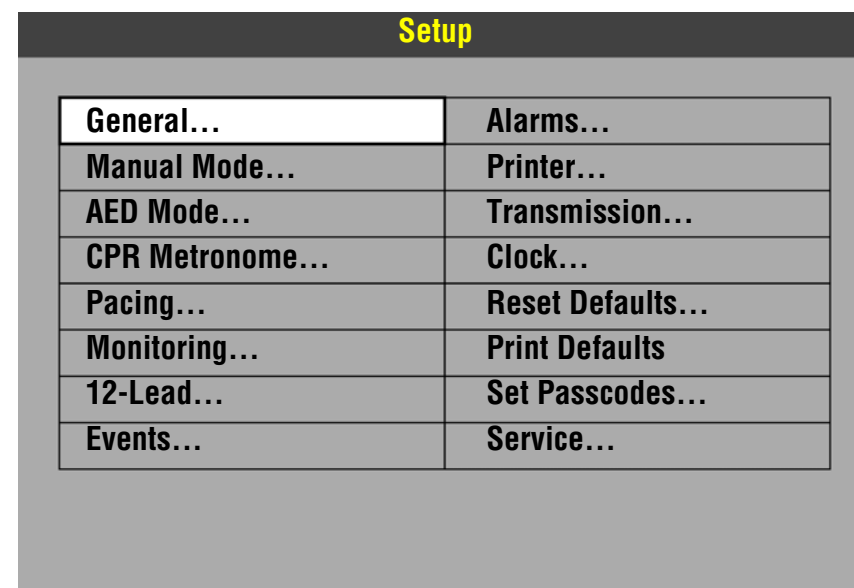
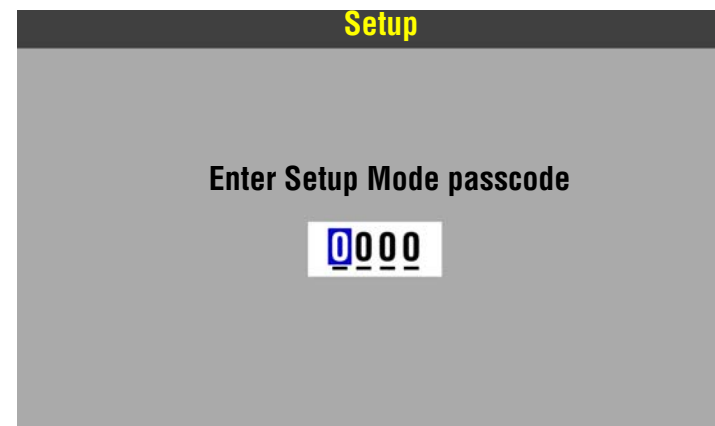

## Service Mode

### About Service Mode

Service mode functions allow qualified service personnel to:

- Perform device calibration routines:
  - ~ Defibrillation calibration
  - ~ Printer calibration
  - ~ CO2 calibration
  - ~ NIBP calibration
  - ~ Temperature calibration
- Perform device tests:
  - ~ Buttons test
  - ~ Pixels test
  - ~ Printer test
  - ~ Voice/Tone test
- View the device status registers:
  - ~ Device Log status
  - ~ Service Log status
  - ~ Device Data status
  - ~ Counters status
  - ~ Clear Memory (clears data management memory)
- Set the Service mode passcode
- Set the maintenance prompt interval

### Entering Service Mode

- ◆ To enter the Service mode:
  1. Enter the Setup Mode (see [Setup Mode \(p. 90\)](#))
  2. Rotate the SPEED DIAL to select SERVICE in the Setup menu, and then press the SPEED DIAL. The Service mode passcode prompt appears. The factory default passcode is 0000; the reserved technician passcode is 5433.
  3. To enter the passcode, rotate the SPEED DIAL to select a digit, and then press the SPEED DIAL to continue. After the last digit is entered, the Service menu appears.
  4. Rotate the SPEED DIAL to select a service option, and then press the SPEED DIAL to display the option overlay.

**Calibration** — See Test and Calibration Procedures (TCP).

**Tests** — See Performance Inspection Procedures (PIP).

**Status** — See [Troubleshooting \(p. 96\)](#).

**Set Passcode** — Set a Service mode access passcode.

**Maint Prompt** — See [Preventive Maintenance \(p. 147\)](#).

**Setup** — Return to the Setup Home Screen.

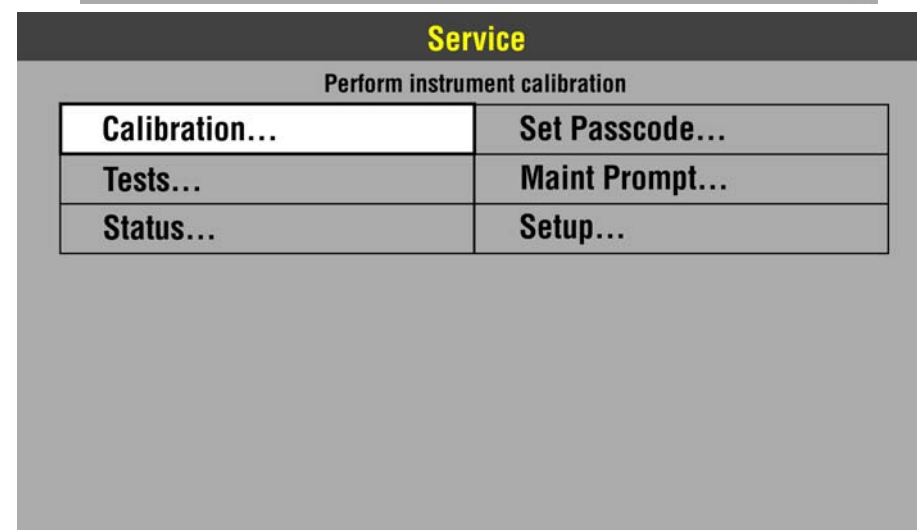

## Demo Mode

### About Demo Mode

Demo mode allows you to practice or demonstrate the monitoring functions of the LIFEPAK 15 monitor/defibrillator, including:

- ECG lead selection
- SpO2
- SpCO
- SpMet
- CO2
- NIBP
- IP
- Temperature
- Trend graphs
- Alarms
- Events

### Entering Demo Mode

- ◆ To enter Demo mode:
  1. Remove all front panel cables from the device (therapy, ECG, etc.). You cannot enter Demo mode if any front panel cable is attached.
  2. Press and hold EVENT and HOME SCREEN, and then turn on the device. The Demo mode screen appears.
  3. To exit Demo mode, turn the device off.

## Archive Mode

### About Archive Mode and Entering Archive Mode

Patient information is stored in Archive mode. When you enter Archive mode, patient monitoring ends and the current Patient Record is saved and closed.

◆ To enter Archive mode:

1. Turn on the device and press OPTIONS.
2. Select ARCHIVES, and then select YES.

**NOTE:** You may be required to enter a password to enter Archive mode.

3. Turn the device OFF to exit Archive mode.

## Troubleshooting

This section describes error code usage, interpretation, and corrective action. It includes a separate troubleshooting chart keyed to the Performance Inspection Procedures (PIP) and individual troubleshooting tests that require operator interpretation. Choose from the following topics:

- [Troubleshooting Chart \(p. 97\)](#)
- [Using the Service/Status Features \(p. 104\)](#)
- [Device Log \(p. 106\)](#)
- [Device Data \(p. 108\)](#)
- [Service Log \(p. 111\)](#)
- [Processing Service Log Codes \(p. 113\)](#)
- [Counters \(p. 114\)](#)
- [Clear Memory \(p. 116\)](#)
- [Service Log Code Categories \(p. 117\)](#)
- [Utility Service Codes \(p. 118\)](#)
- [User Interface Service Codes \(p. 119\)](#)
- [Data Management Service Codes \(p. 121\)](#)
- [System Monitor Service Codes \(p. 122\)](#)
- [Processor Control Service Codes \(p. 123\)](#)
- [ECG Service Codes \(p. 125\)](#)
- [Patient Parameter Service Codes \(p. 126\)](#)
- [Therapy Service Codes \(p. 127\)](#)
- [Printer Service Codes \(p. 139\)](#)
- [Power Management Service Codes \(p. 140\)](#)
- [Corrective Action Codes \(p. 141\)](#)
- [Service LED \(p. 145\)](#)
- [Display Pixels Test \(p. 146\)](#)

### Troubleshooting Chart

**NOTE:** Corrective actions are listed in sequential order according to what is most likely to correct the observed symptom.

**Table 5.1— Corrective Actions**

Area	Observed Symptom	Suggested Corrective Action
Physical Inspection	Loose or broken hardware	Locate and tighten or replace loose items. Locate and replace broken components.
	Evidence of dirt, fluids, or foreign objects	Perform <a href="#">External Cleaning Procedure (p. 156)</a> .
	Damaged keypad or label	Possible A09 Printer Control Keypad failure. Possible A10 Main Keypad failure. Replace Bezel Label (287). Replace Product Identification Label (476).
	Damaged battery pin(s)	Possible battery pin(s) failure.
Power On/Self Test	No power ON	Install fully charged, properly maintained batteries. Possible loose or broken battery pin(s). Possible W04 System/Interface PCB cable connection issue. Possible A03 Power PCB failure.
	Service LED remains ON	See <a href="#">Processing Service Log Codes (p. 113)</a> for assistance.
	MAINTENANCE DUE message appears	See <a href="#">Setting/Resetting the Maintenance Prompt Interval (p. 152)</a> .

Table 5.1— Corrective Actions (Continued)

Area	Observed Symptom	Suggested Corrective Action
LCD Display	Improper LCD response, wrong colors, strips across display	Perform <a href="#">Display Pixels Test (p. 146)</a> . Possible W18 LCD Flex Cable Assembly failure. Possible A11 LCD Assembly failure. Possible A01 System PCB failure. Possible W04 or W18 Flex Cable failure.
Keypads Test	Improper key response	Possible A09 Printer Control or A10 Main Keypad failure. Possible W12 Printer Control or W13 Main Keypad Cable Assy failure. Possible A05 Interface PCB failure. Possible A01 System PCB failure. Possible W04 Flex Cable failure.



**Table 5.1— Corrective Actions (Continued)**

Area	Observed Symptom	Suggested Corrective Action
Printer Test	Missing dots in printed “X”	Verify use of proper printer paper. Clean the printhead. Check A12 Printer Assembly; replace if necessary.
	One or more horizontal lines missing or distorted	Possible A01 System PCB failure.
	Missing or broken characters	Verify use of proper paper. Clean the printhead. Check A12 Printer Assembly; replace if necessary. Possible A01 System PCB failure.
	Improper 25 mm marker spacing	Calibrate the TCP—Printer Calibration at 25 mm.
	Improper 12.5 mm marker spacing	Calibrate the TCP—Printer Calibration at 12.5 mm.
	CHECK PRINTER message appears	Clean the paper sensor (see <a href="#">Paper Sensor Cleaning (p. 160)</a> ). Verify that the printer paper is correctly loaded. Check A12 Printer Assembly; replace if necessary.
Audio Test	Inaudible or garbled audio	Possible W17 Speaker Assembly failure. Possible A05 Interface PCB failure. Possible A01 System PCB failure.

**Table 5.1— Corrective Actions (Continued)**

Area	Observed Symptom	Suggested Corrective Action
Power Source Management Test		<p>Verify instructions and retry test.</p> <p>If available, verify Aux Power adapter LED is ON and input cable is connected to device.</p> <p>Substitute another battery and retry test.</p> <p>Possible loose or broken battery pin(s).</p> <p>Possible A03 Power PCB failure.</p>
QUIK-COMBO or Hard Paddles Delivered Energy Test	No energy discharge	<p>Verify test setup and retry test.</p> <p>See <a href="#">Processing Service Log Codes (p. 113)</a> for assistance.</p> <p>Check therapy cable or hard paddles; replace if necessary.</p> <p>Possible W11 Therapy Connector Cable failure.</p> <p>Possible A04 Therapy PCB failure.</p> <p>Possible A15 Energy Storage Capacitor failure.</p>
	ABNORMAL ENERGY DELIVERY message appears	<p>Possible W11 Therapy Connector Cable failure.</p> <p>Possible A04 Therapy PCB failure.</p>
	Delivered energy out of tolerance	<p>Perform TCP—Defibrillator Energy Calibration.</p>
QUIK-COMBO Patient Impedance Test	Inappropriate screen message response	<p>Verify test setup and retry test.</p> <p>Check therapy cable; replace if necessary.</p> <p>Possible W11 Therapy Connector Cable failure.</p> <p>Possible A04 Therapy PCB failure.</p>
Defibrillation Isolation Test	Measured energy exceeds 2 joules	<p>Verify test setup and retry test.</p> <p>Possible damaged internal high-voltage wiring.</p> <p>Possible internal high-voltage wire connection issue.</p>

**Table 5.1— Corrective Actions (Continued)**

Area	Observed Symptom	Suggested Corrective Action
QUIK-COMBO or Hard Paddles Synchronous Cardioversion Test	No Sync mark	Verify test setup and retry test. Adjust ECG size. Possible A01 System PCB failure.
	Failure to transfer coincident with Sync mark	Take device out of Sync and attempt to discharge. Possible A10 Main Keypad failure. Check therapy cables or hard paddles; replace if necessary.
	Sync discharge time exceeds 60 ms	Verify test setup and retry test. Possible A01 System PCB failure.
Pacing Test	No pacer output	Verify test setup and retry test. Possible W11 Therapy Connector Cable failure. Possible A04 Therapy PCB failure.
User Test	Service LED illuminates, User Test fails	See <a href="#">Processing Service Log Codes (p. 113)</a> for assistance.
ECG Tests	Inappropriate screen message response	Verify test setup and retry test. Check ECG cable; replace if necessary. Possible W07 ECG Connector Cable failure. Possible A01 System PCB failure.
	ECG gain out of tolerance	Verify test setup and retry test. Check ECG cable; replace if necessary. Possible A01 System PCB failure.

**Table 5.1— Corrective Actions (Continued)**

Area	Observed Symptom	Suggested Corrective Action
Paddles Lead ECG Tests	ECG gain out of tolerance	Verify test setup and retry test. Check therapy cable; replace if necessary. Possible A04 Therapy PCB failure. Possible A01 System PCB failure.
	ECG fast restore out of tolerance	Verify test setup and retry test. Check therapy cable; replace if necessary. Possible A04 Therapy PCB failure.
SpO2/SpCO/SpMet Features	Saturation reading missing or out of tolerance.  SpO2 displays XXX in the SpO2 region of the display with the Service LED OFF (review diagnostic log).	Verify test setup and retry test. Retry test with another test subject. Check finger sensor; replace if necessary. Possible device configuration setup error. Possible A16 SpO2 Module failure. Possible W22 SpO2 Connector Cable failure. Possible A06 OEM PCB failure.
	SpO2 displays XXX in the SpO2 region of the display with the Service LED ON	See error code 900e in <a href="#">Table 5.12 on page 126</a> for assistance.
	NIBP Feature	NIBP displays XXX in the NIBP region of the display with the Service LED OFF (review diagnostic log).
NIBP displays XXX in the NIBP region of the display with the Service LED ON		See error code 9119 in <a href="#">Table 5.12 on page 126</a> for assistance.

**Table 5.1— Corrective Actions (Continued)**

Area	Observed Symptom	Suggested Corrective Action
Temperature Feature	TEMP: ACCURACY OUTSIDE LIMITS message is displayed, and the temperature value is “XXX”	Temperature calibration required; verify test setup and test equipment accuracy requirements. Possible temperature adapter cable failure. Possible A01 System PCB failure.
CO2 Feature <b>Note:</b> The CO2 module can take up to 6 minutes for all internal processes to complete.	CO2 fails calibration	Verify test setup and retry test. Check to see if CO2 calibration gas canister is empty. Check FilterLine to see if it is disconnected. Check for pinched hose inside device. Possible A23 CO2 module failure.
	CO2 displays FilterLine Blockage message	Replace FilterLine. Possible occlusion or kinking of input tubing between CO2 connector and CO2 module. Possible A23 CO2 module failure.
	CO2 displays XXX in the CO2 region of the display with Service LED OFF	Replace FilterLine. Possible occlusion or kinking of tubing inside device. Possible A23 CO2 module failure.
	CO2 displays XXX in the CO2 region with Service LED ON (review diagnostic log).	Review error code 9205 in <a href="#">Table 5.12 on page 126</a> .
	CO2 FilterLine installed with no indication on display that CO2 is connected	Clean the CO2 input connector with compressed air to remove loose debris. Replace FilterLine.
	CO2 fails leak test	Leaking exhaust hose, CO2 nipple on rear case.

## Using the Service/Status Features

### Introduction

The device includes a series of service/status screens and menus that detail device data such as stored manufacturing data, recorded errors, and counters for shock and pacing operation.

### Displaying the Service/Status Submenu

- ◆ To display the Service/Status submenu:
  1. Press and hold the OPTIONS and EVENT buttons, and then turn the device ON. Continue holding until the Setup mode passcode prompt appears.
  2. Enter the passcode **5433** by rotating the SPEED DIAL to select a digit, and then pressing the SPEED DIAL to continue. After the last digit is entered, the Setup menu appears.
  3. Rotate the SPEED DIAL to select SERVICE in the Setup menu, and then press the SPEED DIAL. At the service passcode prompt, enter the passcode **5433**. The Service menu appears.

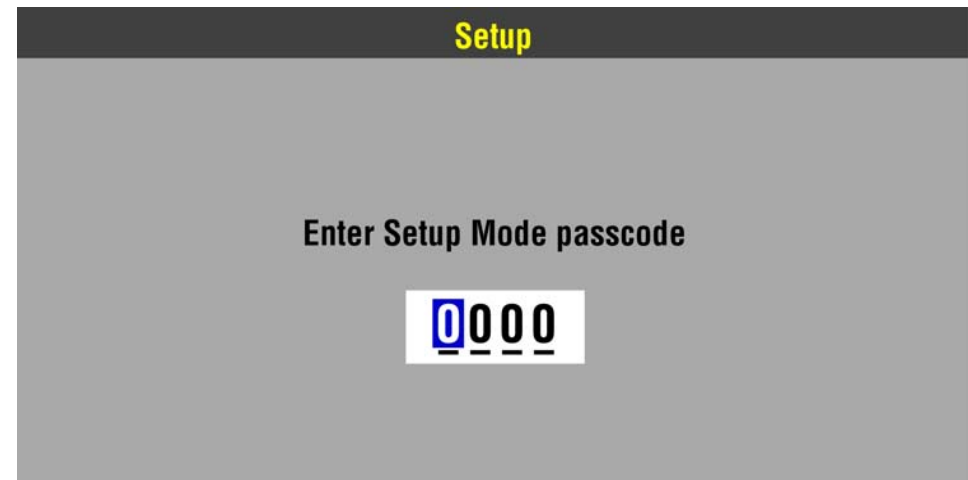

4. Rotate the SPEED DIAL to select STATUS, and then press the SPEED DIAL to display the Service/Status submenu.

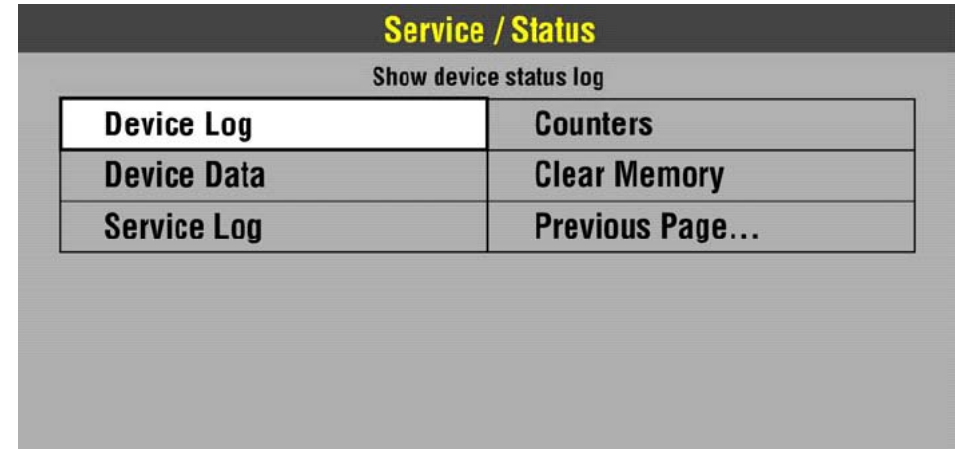

## Device Log

### Introduction

The Device Log displays accumulative device operations, such as the shock count.

### Displaying the Device Log

- ◆ To display the Device Log:
  1. Display the Service/Status submenu ([Displaying the Service/Status Submenu \(p. 104\)](#)), and then select DEVICE LOG.

Service / Status / Device Log	
Fault Messages	Yes
Power Cycle Count	385
Pacing Count	90
Shock Count	1478
Power On Time	221.5
Printer On Time	25.4
SpO2 Operating Time	67.1
CO2 Operating Time	36.85
NIBP Inflation Cycles	99

Press Speed Dial to exit



## Device Log Entries

The Device Log includes the data listed in [Table 5.2](#).

**Table 5.2—Device Log Entries**

Data	Description
Fault Messages	Records YES or NO to indicate whether there are any error codes stored in the Service Log (see <a href="#">Processing Service Log Codes (p. 113)</a> )
Power Cycle Count	Number of times the device has been turned on
Pacing Count	Total pacing pulses delivered by the device
Shock Count	Total times the device defibrillation capacitor has been charged
Power On Time	Total device power-on time
Printer On Time	Total printer running time
SpO2 Operating Time	Total SpO2 running time
CO2 Operating Time	Total CO2 running time
NIBP Inflation Cycles	Total number of inflation cycles

## Device Data

### Introduction

Device Data displays essential device characteristics, such as the serial number and part numbers.

### Displaying the Device Data

- ◆ To display Device Data:
  1. Display the Service/Status submenu ([Displaying the Service/Status Submenu \(p. 104\)](#)), and then select DEVICE DATA.

Service / Status / Device Data	
Serial Number	36260899
Manufacture Date	01 Jan 2008
Display String P/N	3208032-000 1.0.0
Audio P/N	3208031-001 1.0.1
FPGA Version	0210 0400
System SW P/N	3207410-001 0.7.4
Power SW P/N	3207365-000 1.3.3
SBC P/N	3456789-002
SpO2 S/N	3092874-000
SpO2 Version	V.1.1.1.2, V7.0.3.3
CO2 Version	V02.20, SN14886
NIBP Version	30
Bluetooth Version	3.8
Paddles Control SW P/N	3313496-001 0.3.0 001
Energy Delivery SW P/N	3313497-001 0.3.3 001
Paddles Sensing SW P/N	3313498-001 0.3.1 001

Press Speed Dial to exit

### Device Data Entries

The device data includes item listed in [Table 5.3](#).

**Table 5.3—Device Data Entry**

Data	Description
Serial Number	Device serial number. If the serial number is blank, the device has lost important configuration data.
Manufacture Date	Date when the device was manufactured, specifically, when the operating software was loaded
Display String P/N	Font software part number and version, language dependent
Audio P/N	Audio software part number and version, language dependent
FPGA Version	Field-Programmable Gate Array software version
System SW P/N	System software part number and version number. System software part number is also displayed on the start screen
Power SW P/N	Power assembly software part number and version
SBC P/N	Single-Board Computer hardware part number and version
SpO2 S/N	SpO2 hardware serial number
SpO2 Version	SpO2 software version numbers
CO2 Version	CO2 software version number and serial number
NIBP Version	NIBP software version number
Bluetooth Version	Bluetooth software version number and date stamp
Paddles Control SW P/N	Therapy assembly software part number and version for the paddles control processor.

Table 5.3—Device Data Entry (Continued)

Data	Description
Energy Delivery SW P/N	Therapy assembly software part number and version for the energy delivery processor.
Paddles Sensing SW P/N	Therapy assembly software part number and version for the paddles sensing processor.

## Service Log

### Introduction

The device operating software is designed to detect and report any improper operation or device malfunction by using a system of service codes. When an internal program or process fails to execute properly, a specific four-digit hexadecimal service code is written into the device Service Log (for example, 500e), and the front panel [Service LED \(p. 145\)](#) illuminates. The illuminated Service LED is your signal to examine the Service Log and process any reported errors (see [Processing Service Log Codes \(p. 113\)](#)).

Service codes rarely occur and should be investigated thoroughly by a qualified service technician before the device is placed back into active use. Always complete the Performance Inspection Procedures (PIP) after encountering and clearing any service code(s).

Service codes stored in the Service Log may not necessarily indicate a permanent failure. Service codes can indicate transient electromagnetic interference (EMI) or electrostatic discharge (ESD). If you suspect transient EMI or ESD as the source of an error, clear the service code(s) as described in [Clearing the Service Log \(p. 112\)](#), and then shut down and restart the device. If the service code does not recur, it may have been the result of EMI or ESD.

### Displaying the Service Log

- ◆ To display the Service Log:
  1. Display the Service/Status submenu ([Displaying the Service/Status Submenu \(p. 104\)](#)).
  2. Select SERVICE LOG. The Service/Status/Service Log overlay displays service codes by date, time, service code, and extension.

### Clearing the Service Log

- ◆ To clear the Service Log:
  1. Display the Service/Status submenu ([Displaying the Service/Status Submenu \(p. 104\)](#)), and then select SERVICE LOG.
  2. Using the SPEED DIAL, select CLEAR LOG on the Service/Status/Service Log overlay.

#### WARNING

**POSSIBLE DATA LOSS** The CLEAR LOG action will delete the service code(s) in the Service Log. Do not clear the Service Log until the service code is fully investigated.

**NOTE:** The CLEAR LOG action will record the error(s) on the 100-mm printer.

3. Turn the device OFF or navigate to other service topics, as required.

Service / Status / Service Log							
Return to previous page							
Clear Log				Previous Page...			
01/05/08	14:25:50	0312	29520457	01/06/08	14:26:56	0314	83220007
01/05/08	14:26:56	0314	83220007	01/06/08	16:30:21	1685	41363801
01/05/08	16:30:21	1685	41363801	01/06/08	18:36:11	2164	28250457
01/05/08	16:39:03	0124	69820010	01/06/08	20:46:32	3012	75400259
01/05/08	18:25:05	3591	57220031				
01/05/08	18:36:11	2164	28250457				
01/05/08	19:11:00	0016	37939456				
01/05/08	20:25:10	0000	57958454				
01/05/08	20:44:58	0000	27915683				
01/05/08	20:45:22	2222	22224444				
01/05/08	20:46:32	3012	75400259				
01/05/08	21:00:00	0000	00000100				
01/05/08	22:25:50	2130	29520457				
01/05/08	23:10:10	1010	10101056				

## Processing Service Log Codes

When an internal program or process fails to execute properly, a service code is written into the device [Service Log \(p. 111\)](#) (for example, 500e), and the front panel Service LED (see [Service LED \(p. 145\)](#)) illuminates.

◆ To process service codes:

1. Review the service code(s) by displaying the [Service Log \(p. 111\)](#).
2. Clear the Service Log ([Clearing the Service Log \(p. 112\)](#)), and then turn the device OFF. The CLEAR LOG action will record the service code(s) on the 100-mm printer.
3. Complete the Performance Inspection Procedures (PIP).
  - ~ If the PIP completes successfully, the device may be returned to regular use. The service code(s) may have been related to EMI or ESD.
  - ~ If the Service LED illuminates at any time during the PIP, stop the PIP and investigate the PIP failure using the [Troubleshooting Chart \(p. 97\)](#). Continue with step 4.
4. Locate the specific corrective action for a service code as follows:
  - a. Display the Service Log to view the service code(s).
  - b. Review the [Service Log Code Categories \(p. 117\)](#) for general information.
  - c. Click the appropriate link in the Initial Digit column and locate your specific service code in the table.
  - d. Click the link(s) in the Corrective Action column to view the corresponding corrective action.
  - e. Service the device based on these inputs, and then repeat the Performance Inspection Procedures (PIP).
5. For persistent Service Log codes, contact your local Physio-Control service or sales representative.

## Counters

### Introduction

The device counters display the number of shocks delivered in both subtotal and running-total counts.

### Displaying the Counters

- ◆ To display the counters:
  1. Display the Service/Status submenu ([Displaying the Service/Status Submenu \(p. 104\)](#)), and then select COUNTERS.

Service / Status / Counters		
Go back to previous page		
Clear All		Previous Page...
<b>Total Shocks</b>		<b>7445</b>
<b>360J</b>	<b>707</b>	<b>2325</b>
<b>225 - 325J</b>	<b>1215</b>	<b>3399</b>
<b>0 - 200J</b>	<b>466</b>	<b>1721</b>



### Understanding the Counters

The Service/Status/Counters overlay displays the counters shown in [Table 5.4](#).

**Table 5.4—Counters**

Data	Description
Total Shocks	Running total of all the shocks ever delivered by the device. This counter cannot be reset.
360 J Shocks	The number in the box represents the number of 360-joule shocks delivered since the last reset. The number in the right column is a running total of all 360-joules shocks ever delivered by the device (cannot be reset).
225 - 325 J Shocks	The number in the box represents the number of 225-joule to 325-joule shocks delivered since the last reset. The number in the right column is a running total of all 225-joule to 325-joule shocks ever delivered by the device (cannot be reset).
1 - 200 J Shocks	The number in the box represents the number of 0-joule to 200-joule shocks delivered since the last reset. The number in the right column is a running total of all 0-joule to 200-joule shocks ever delivered by the device (cannot be reset).

### Resetting the Counters

Select CLEAR ALL on the Service/Status/Counters overlay to reset the subtotal counters in the boxes, but not the running-total counters.

## Clear Memory

### Introduction

The Clear Memory feature is used to clear the FLASH data management memory on the A01 System PCB. Specifically, you clear:

- **ECG Data** – All stored ECG data (up to 360 minutes of First-In-First-Out continuous ECG waveforms) is permanently deleted.
- **Patient Reports** – All stored patient reports are permanently deleted.

Normally you clear the data management memory after the device is placed into new or different use and the previous patient data is no longer required. You also clear the data management memory as part of certain service actions.

**NOTE:** To save important patient data before clearing the data management memory, transmit the data to a receiving device or print out individual patient data (see “Data Management” in the operating instructions).

### Clearing the Data Management Memory

- ◆ To clear the data management memory (this is permanent; there is no undo):
  1. Display the Service/Status submenu as described in [Displaying the Service/Status Submenu \(p. 104\)](#), and then select CLEAR MEMORY.
  2. A countdown timer appears to indicate the clearing process, which requires a nominal 30 seconds.

### Service Log Code Categories

Service log codes are organized into the categories shown in [Table 5.5](#), in four-digit hexadecimal format.

**Table 5.5—Service Code Categories**

Initial Digit	Category	Detail Table	Associated PCBs and Assemblies
0xxx	UT	<a href="#">Utility Service Codes (p. 118)</a>	A01 System
1xxx	UI	<a href="#">User Interface Service Codes (p. 119)</a>	A01 System, A04 Therapy, A05 Interface, A09 Printer Control Keypad, A10 Main Keypad
3xxx	DM	<a href="#">Data Management Service Codes (p. 121)</a>	A01 System
4xxx	SM	<a href="#">System Monitor Service Codes (p. 122)</a>	A01 System, A04 Therapy
5xxx	PC	<a href="#">Processor Control Service Codes (p. 123)</a>	A01 System
6xxx	ECG	<a href="#">ECG Service Codes (p. 125)</a>	A01 System
9xxx	PPxx	<a href="#">Patient Parameter Service Codes (p. 126)</a>	A01 System, A06 OEM PCB, A16 SpO2 Module, A21 NIBP Module, A23 CO2 Module
axxx	TH, DE, PA, PC, PS, ED	<a href="#">Therapy Service Codes (p. 127)</a>	A01 System, A03 Power, A04 Therapy, A15 Energy Storage Capacitor
bxxx	PR	<a href="#">Printer Service Codes (p. 139)</a>	A01 System, A12 Printer Assembly
cxxx	PM	<a href="#">Power Management Service Codes (p. 140)</a>	A01 System, A03 Power

### Utility Service Codes

**Table 5.6—Initial Digit 0, Utility Service Codes (UT)**

Code	Service Code Description	Corrective Action Code
0002	UT_ERROR_FLASH_VPP (Error during flash block erase. Valid for all flash sizes.)	1
0003	UT_ERROR_FLASH_ERASE (Flash memory block erase failure. Valid for all flash sizes.)	1
0004	UT_ERROR_FLASH_8BIT_WRITE (Error during 8-bit flash write. Error status bits indicate error information. Flash not updated.)	1
0005	UT_ERROR_FLASH_16BIT_WRITE (Error during 16-bit flash write. Error status bits indicate error information. Flash not updated.)	1
0006	UT_ERROR_FLASH_PAGE_WRITE (Error during 16-bit flash write. Error status bits indicate error information. Flash not updated.)	1
0008	UT_ERROR_ADC_READ (Error during ADC read. ADC serial channel not available.)	1
000a	UT_ERROR_DAC_FAILURE (ECG DAC self-test failed. ECG DAC failure after cold boot.)	1
000c	UT_ERROR_ADC_TEST_REG (ADC Test Register Failure. ADC Test Register test failure. Failure to read the register after three tries. May also be caused by the serial channel not responding.)	1
000d	UT_ERROR_ADC_CAL_NOT_COMPLETE (ADC busy bit not clear 150 ms after calibration. ADC Self-Test Calibration test failure.)	1
000e	UT_ERROR_VP_FLASH_ID_UNKNOWN (Unknown manufacture/device ID for voice/printer flash.)	1
000f	UT_ERROR_DP_FLASH_ID_UNKNOWN (Unknown manufacture/device ID for data/program flash.)	1

### User Interface Service Codes

**Table 5.7—Initial Digit 1, User Interface Service Codes (UI)**

Code	Service Code Description	Corrective Action Code
1005	UI_ERROR_DISPLAY_SELF_TEST (Self-test failed. Upper 16 bits of status code contain the expected CRC; lower 16 bits contain the actual CRC.)	1
1006	UI_ERROR_ENERGY_FAULT (Defib charge out of 15% tolerance. Occurs only during manual mode.)	28, 10, 6, 1
1007	UI_ERROR_12LEAD_KEY_SEEN (This unit is not configured to support 12-lead, but the software saw a key closure of this key.)	11, 1
1008	UI_ERROR_ANALYZE_KEY_SEEN (This unit is not configured to support AED mode, but the software saw a key closure of this key.)	11, 1
100a	UI_ERROR_NIBP_KEY_SEEN (This unit is not configured to support NIBP, but the software saw a key closure of this key.)	11, 1
100b	UI_ERROR_CURRENTUP_KEY_SEEN (This unit is not configured to support pacing, but the software saw a key closure of this key.)	11, 1
100c	UI_ERROR_CURRENTDOWN_KEY_SEEN (This unit is not configured to support pacing, but the software saw a key closure of this key.)	11, 1
100d	UI_ERROR_RATEUP_KEY_SEEN (This unit is not configured to support pacing, but the software saw a key closure of this key.)	11, 1
100e	UI_ERROR_RATEDOWN_KEY_SEEN (This unit is not configured to support pacing, but the software saw a key closure of this key.)	11, 1
100f	UI_ERROR_PACER_KEY_SEEN (This unit is not configured to support pacing, but the software saw a key closure of this key.)	11, 1
1010	UI_ERROR_PAUSE_KEY_SEEN (This unit is not configured to support pacing, but the software saw a key closure of this key.)	11, 1
1037	UI_ERROR_UNCONFIGURED_BUTTON (Button test detected key that should not be present in current hardware configuration.)	11, 1

Table 5.7—Initial Digit 1, User Interface Service Codes (UI) (Continued)

Code	Service Code Description	Corrective Action Code
1038	UI_ERROR_CPR_KEY_SEEN (This unit is not configured to support AED mode, but the software saw a key closure of this key.)	11, 1
103b	UI_ERROR_MISSING_LANGUAGE (Configured language was not available.)	28, 1
1fff	UI_ERROR_EXTRA_INFORMATION (Extra error code information for an above error.)	9

### Data Management Service Codes

Table 5.8—Initial Digit 3, Data Management Service Codes (DM)

Code	Service Code Description	Corrective Action Code
3005	DM_ERROR_DATABASE_ERASE_ADJUST (Not able to write new lines for new oldest record; disables flash.)	31, 1
3006	DM_ERROR_DATABASE_ERASE_FAILED (Erase block failed; disables flash; param = block requested.)	31, 1
3007	DM_ERROR_DATABASE_ERASE_VERIFY (Verification of erased block failed; disabled flash; param = block.)	31, 1
3008	DM_ERROR_DATABASE_FLASH_ERASE (Erase database failed; disables flash; param = block # of failure.)	31, 1
3fff	DM_ERROR_EXTRA_INFORMATION (Extra error code information for an above error.)	28, 31, 1

### System Monitor Service Codes

**Table 5.9—Initial Digit 4, System Monitor Service Codes (SM)**

Code	Service Code Description	Corrective Action Code
4009	SM_ERROR_RAM_FAILURE (RAM failure during self-test. 16-bit ram test failure; param = address of failure.)	1, 6
400a	SM_ERROR_BAD_CRC (CRC in program flash bad. Program test failure; value = high 16 bits expected CRC, low 16 bits include computed CRC.)	1, 6
400b	SM_ERROR_CRC_FAILURE (Program contents failed CRC test; value = high 16 bits expected CRC, low 16 bits include computed CRC.)	1, 6
400c	SM_ERROR_VOLTAGE_LOW (ADC voltage reading low. HW voltage low; status code = high 8 bits contains ADC value, low 8 bits contains channel #.)	6, 1
400d	SM_ERROR_VOLTAGE_HIGH (ADC voltage reading high. HW voltage high; status code = high 8 bits contains ADC value, low 8 bits contains channel #.)	6, 1
4010	SM_ERROR_SERVICE_LED (Service LED failure. LED expected to be on, but it is not.)	11
4011	SM_ERROR_DEFIB_SERVICE_SYNC (Failed to synchronize the defib charge after cold boot; param = time since last boot.)	11
4012	SM_ERROR_FONT_VOICE_CKSUM (Invalid checksum in font/voice. Font/voice checksum error found after cold boot.)	1, 6
4013	SM_ERROR_FONT_VOICE_CRC (Invalid CRC in font/voice flash. Font/voice CRC error; status code = top 16 bits are stored CRC, low 16 bits are computed CRC.)	1, 6



### Processor Control Service Codes

**Table 5.10—Initial Digit 5, Processor Control Service Codes (PC)**

Code	Service Code Description	Corrective Action Code
5002	PC_ERROR_WATCHDOG_SHORT_FAILURE (Main watchdog short test failure. Watchdog failure; param: 0=None, 1=short, 2=long, 3=power.)	1
5003	PC_ERROR_WATCHDOG_LONG_FAILURE (Main watchdog long test failure. Watchdog failure; param: 0=None, 1=short, 2=long, 3=power.)	1
5004	PC_ERROR_WATCHDOG_UNEXPECTED (Unexpected main watchdog reset. Top 16 bits = seconds since last set. Low 16 bits = watchdog status.)	1
5005	PC_ERROR_RAM_AT_BOOT (RAM error detected during boot; param = Ram Addr of error.)	1
5006	PC_ERROR_BAD_CHECKSUM (Program contents failed Checksum test.)	1
500d	PC_ERROR_CONFIG_VERSION (System configuration version mismatch; param = value read.)	1
500e	PC_ERROR_CONFIG_CRC (NVRAM system configuration CRC bad; param = value read.)	2, 1
5011	PC_ERROR_METERS_VERSION (System meters version mismatch; param = value read.)	2, 1
5012	PC_ERROR_METERS_CRC (NVRAM system meters/counters CRC bad; param = value read.)	2, 1
5013	PC_ERROR_MFG_DATA_VERSION (Manufacturing data version mismatch.)	2, 1
5014	PC_ERROR_MFG_DATA_CRC (NVRAM manufacturing data CRC bad.)	1
5015	PC_ERROR_FORCED_RESET_FAILED (Forced watchdog reset failed. Unit failed to reset.)	1

**Table 5.10—Initial Digit 5, Processor Control Service Codes (PC)**

Code	Service Code Description	Corrective Action Code
5019	PC_ERROR_RTC_BAD (RTC is not running.)	2, 1
501a	PC_ERROR_RTC_DRIFT (Processor and RTC time out of sync; param = drift.)	1
5032	PC_ERROR_RTC_NO_BATTERY (No Coin cell battery for the RTC.)	2, 1
5033	PC_ERROR_RTC_READ (RTC read is not consistent.)	2, 1
503d	PC_ERROR_3AM_EXCEPTION (Problem occurred during the 3AM test)	2, 6, 1
503e	PC_ERROR_3AM_STOPPED (A condition caused the device to warmstart during the 3AM test)	2, 6, 1

### ECG Service Codes

Table 5.11—Initial Digit 6, ECG Service Codes (ECG):

Code	Service Code Description	Corrective Action Code
600c	ECG_ERROR_DSP_VOLTAGE (DSP preamp supply voltage out of range.)	1
600d	ECG_ERROR_PREAMP_CALIBRATION (NVRAM calibration constants out of range. HW unit reported calibration error.)	20
600e	ECG_ERROR_NVRAM_FAULT (NVRAM redundant value mismatch detected. NVRAM possibly bad.)	20

### Patient Parameter Service Codes

**Table 5.12—Initial Digit 9, Patient Parameter Service Codes (PP)**

Code	Service Code Description	Corrective Action Code
900e	PPSP_ERROR_CONFIG (SpO2 module detected but not in manufacturing configuration; param: 1 = found Masimo but should not, 2 = unit not found.)	8
902d	PPSP_ERROR_MNC_CONFIG_B (SpO2 module detected but manufacturing configuration, not configured for Nellcor sensor support; param: 1 = Masimo doesn't support config B, 2 = Device doesn't support config B.)	8
9119	PPNI_ERROR_CONFIG_MISMATCH (Device with NIBP module not configured for it; param = SW version.)	8
9205	PPCO_ERROR_WRITING_TO_MODULE (CO2 module detected but not in manufacturing configuration. Unit disabled. Param = config-info.)	8
9304	PPTI_CONFLICT_IP_TEMPER_ERROR_CONFIG (IP and Temperature manufacturing configuration bits both on at the same time.)	8

### Therapy Service Codes

**Table 5.13—Initial Character a, Therapy Service Codes (TH)**

Code	Service Code Description	Corrective Action Code
a002	TH_ERROR_DEFIB_LINK_DOWN (Lost contact with defib processor. Serial communications link between the main and defib processor is not functioning. This unit can no longer administer defib therapy. Cycling power may clear the error temporarily, but unit is questionable; param = last defib message time stamp.)	10
a003	TH_ERROR_PACER_LINK_DOWN (Lost contact with pacemaker processor. Serial communications link between the main and pacemaker processor is not functioning.)	10
a004	TH_ERROR_UNEXPECTED_ENERGY (Unexpected energy in the capacitor. No charge delivered.)	10
a005	TH_ERROR_CAP_OVERCHARGED (Over-charged capacitor.)	10
a008	TH_ERROR_DEFIB_DISABLE (No communication with defib HW.)	10
a00a	TH_ERROR_DE_WRONG_ENG_SELECT (Incorrect energy selected; param = energy index.)	7, 10
a00b	TH_ERROR_SHOCK_NOT_DELIVERED (Shock not delivered.)	10
a00d	TH_ERROR_CHARGING_EXPIRED (Charging time expired.)	10
a00f	TH_ERROR_CAP_OUT_OF_RANGE (Capacitor is out of range. Calibration failure.)	10
a010	TH_ERROR_PA_RATE_OUT_OF_RANGE (Pacing rate out of tolerance; param: high-16 = pacemaker selected range, low-16 = pacemaker actual rate.)	10
a011	TH_ERROR_PA_CURRENT_OUT_OF_RANGE (Pacing current out of tolerance; param: high-16 = selected current, low-16 is actual current.)	10

**Table 5.13—Initial Character a, Therapy Service Codes (TH)**

Code	Service Code Description	Corrective Action Code
a017	TH_ERROR_DEFIB (Defib. error report)	10
a018	TH_ERROR_PACER (Pacer error report)	15
a01a	TH_ERROR_PACER_FAULT (Pacing fault condition occurred [rate(0), current(1), pulse width(2)], limit exceeded; param = pacer-fault type.)	6, 1
a01b	TH_ERROR_DEFIB_WDT_DISABLE_FAIL (Unable to turn off defib WDT; param = ASIC defib ctrl register.)	6, 1
a020	TH_ERROR_PACER_DISABLE (Pacer disabled; cannot communicate with processor.)	6, 1
a021	TH_ERROR_CAP_CHARGE_FAIL (Cap. stays zero while charging. No charge; param = defib setting.)	6, 1
a022	TH_ERROR_CORRUPT_ENERGY_SELECT (Energy select corrupt; param = main energy selection.)	6
a023	TH_ERROR_XFER_ENABLE_ON (Defib transfer-enable line high unexpected. Defib transfer-enable line was not off during startup.)	6, 1
a024	TH_ERROR_VCAP2_SATURATED (VCAP2 reading full scale all the time. Reading not processed.)	6, 1
a026	TH_ERROR_ENERGY_RESIDUE (There is still energy on the cap.)	6, 1
a027	TH_ERROR_PA_RATE_CORRUPT (Pacing rate storage corrupted; param: high-16 = rate selected, low-16 = actual rate.)	15
a028	TH_ERROR_CAL_ENERGY_FAIL (Calibrated voltage is out of range; param: high-16 = table index, low-16 = voltage count.)	6, 1
a029	TH_ERROR_BTE_FAIL (Error condition with BTE board; param: high-16 bits = fault type, low-16 bits = cedar state.)	10, 1
a02b	TH_ERROR_DEFIB_CONFIG (Conflicting defib type. Cold boot if test bit set; otherwise, disable biphasic; param = test-bit setting.)	28
a02c	TH_ERROR_DUMP_LINE_FAIL (One of dump lines failed; param = test ID.)	19

**Table 5.13—Initial Character a, Therapy Service Codes (TH)**

Code	Service Code Description	Corrective Action Code
a02d	TH_ERROR_WRONG_DEFIB_TYPE (Wrong Defib. type for software.)	28, 11
a02e	TH_ERROR_ADC_READ (ADC read failure when getting cap charge.)	28
a02f	TH_ERROR_MSG_ID_UNKNOWN (Message ID from System PCB is unknown)	28
a032	TH_ERROR_PC_LINK_DOWN (Lost contact with the Paddles Control subsystem)	6, 1
a033	TH_ERROR_PS_LINK_DOWN (Lost contact with the Paddles Sensing subsystem)	6, 1
a034	TH_ERROR_ED_LINK_DOWN (Lost contact with the Energy Delivery subsystem)	6, 1
a035	TH_ERROR_COMPATIBILITY_ERROR (Wrong version of software is installed)	28
a036	TH_ERROR_NO_SELFTEST_RESPONSE (Did not respond to 3AM or User Test)	6, 1
a037	TH_ERROR_XFER_ENGAGE (Transfer was not engaged when expected)	6, 1
a038	TH_ERROR_VCOMP_IMPED_INVALID (Error indicates that a valid normal patient impedance was not received within specified time period, and held off charge will begin without voltage compensation)	6
a039	TH_ERROR_INVALID_STATE (If the therapy processor (PC, PS, or ED) reports an incorrect state after 3 attempts to correct, the therapy processor will be reset.)	6
a101	DE_ERROR_LONG_WDT (Long watchdog test failed or watchdog did not reset in time.)	7, 10
a102	DE_ERROR_SHORT_WDT (Short watchdog test failed.)	10
a103	DE_ERROR_SCI_RCV (Serial port receiver error.)	10

**Table 5.13—Initial Character a, Therapy Service Codes (TH)**

Code	Service Code Description	Corrective Action Code
a104	DE_ERROR_XFER_KEY (Defib HW error.)	10
a106	DE_ERROR_ENERGY_OUT_OF_BOUND (VCAP-1 over/under charge.)	28, 10
a107	DE_ERROR_HP_ENG_SELECT (Cannot determine the rotary setting.)	10
a109	DE_ERROR_CAL_CRC (Calibration Table CRC error.)	10
a10b	DE_ERROR_CHG_TIME (Takes too long to reach charge.)	10
a10c	DE_ERROR_CHG_ENABLE (CHG_EN1 is stuck high.)	11, 10
a10d	DE_ERROR_DUMP_ENERGY (Defib HW error.)	10
a10e	DE_ERROR_RCV (Defib HW error.)	10
a111	DE_ERROR_ENERGY_NOT_ZERO (Unexpected energy while biphasic is in high-pot test.)	10
a112	DE_ERROR_TEST_XFER_ENABLE (Problem with transfer; turn on at main.)	10
a113	DE_ERROR_TEST_XFER_ENGAGE (Error reading the transfer engage feedback.)	10
a114	DE_ERROR_TEST_DUMP_RELAY (Biphasic error.)	10
a115	DE_ERROR_TEST_ADC (Defib HW error.)	10
a116	DE_ERROR_TEST_DAC (Defib HW error.)	10
a117	DE_ERROR_TEST_HARDWARE (Defib HW error.)	10



**Table 5.13—Initial Character a, Therapy Service Codes (TH)**

Code	Service Code Description	Corrective Action Code
a118	DE_ERROR_TEST_RAM (Defib HW error.)	10
a119	DE_ERROR_TEST_ROM (Defib HW error.)	10
a11a	DE_ERROR_TEST_CPU (Defib HW error.)	10
a11d	DE_ERROR_XFER_TIMEOUT (Defib HW error.)	10
a11e	DE_ERROR_BUTTONS_UP (Defib HW error.)	10
a11f	DE_ERROR_SYNC_INTERRUPT (Defib HW error.)	10
a120	DE_ERROR_SELF_TEST_INCOMPLETE (Defib HW error.)	10
a123	DE_ERROR_CAL_RCV_CRC (CRC failed for new calibration data.)	10
a124	DE_ERROR_CAL_NVM_CRC (Cannot write energy table to EEPROM.)	10
a125	DE_ERROR_DAC_WRITE (Byte could not be written to the DAC through the SPI interface.)	10
a126	DE_ERROR_ADC_READ (Cannot read from ADC.)	10
a127	DE_ERROR_TEST_MODE (Must be idle to switch to test mode.)	10
a129	DE_ERROR_XFER_CABLE (Defib HW error.)	10
a12a	DE_ERROR_XFER_PADDLE (Defib HW error.)	10
a12c	DE_ERROR_CHG_INHIBIT (Defib HW error.)	10

**Table 5.13—Initial Character a, Therapy Service Codes (TH)**

Code	Service Code Description	Corrective Action Code
a12d	DE_ERROR_CHG_ENABLE_FAIL (Charge enable feedback indicates not charging.)	10
a12e	DE_ERROR_BTE_FAULT (Cedar BTE Fault Line State.)	10
a12f	DE_ERROR_BTE_FAULT_CLEARED (Cedar BTE Fault Line State.)	10
a130	DE_ERROR_BTE_RESET (Defib HW error.)	10
a131	DE_ERROR_NO_BTE_HW (Biphasic HW not found.)	10
a132	DE_ERROR_NO_BTE_XFER (Defib HW error.)	10
a133	DE_ERROR_BTE_CEDAR_DRV_HI (A/D high bit sticky.)	10
a201	PA_ERROR_LONG_WDT (Long watchdog timer test failed.)	15
a202	PA_ERROR_SHORT_WDT (Short watchdog timer test failed.)	15
a203	PA_ERROR_SCI_RCV (SCI received overrun, framing or parity. Unit used near high EMI causing these issues.)	15
a204	PA_ERROR_2MS_OVERRUN (2 ms ECG sampling overrun.)	15
a208	PA_ERROR_MSG_RESYNC (Received message incomplete.)	15
a209	PA_ERROR_MSG_SIZE (Received msg size error/input buff full.)	15
a20d	PA_ERROR_PACE_OVERRUN (Pacing pulse process overrun. Set current to zero.)	15
a20e	PA_ERROR_PULSE_WIDTH (Pacing pulse too long.)	15

**Table 5.13—Initial Character a, Therapy Service Codes (TH)**

Code	Service Code Description	Corrective Action Code
a20f	PA_ERROR_A2D_INT (Internal A/D conversion timeout. Set current to zero.)	15
a210	PA_ERROR_A2D_EX (External A/D conversion timeout. Current set to zero.)	15
a211	PA_ERROR_SPI (SPI transfer timeout. Current set to zero.)	15
a212	PA_ERROR_RAM_TEST (RAM test failed. Reset Pacer Processor.)	15
a213	PA_ERROR_ROM_TEST (ROM CRC test failed.)	15
a214	PA_ERROR_CPU_TEST (Stack overrun occurred.)	15
a215	PA_ERROR_STACK_CHECK (Isolated +5 V ref. out of range.)	15
a216	PA_ERROR_V_ISO_MON (HV present when not pacing.)	15
a217	PA_ERROR_V_12V_MON (+12 V voltage out of range.)	15
a218	PA_ERROR_V_HVIS_SENSE (HV present when not pacing.)	15
a219	PA_ERROR_V_HVIS (HVIS voltage out of range.)	15
a21a	PA_ERROR_CAL_CURRENT (Current calibration failed.)	15
a21b	PA_ERROR_CAL_Z_300 (Impedance 300 calibration failed.)	15
a21c	PA_ERROR_CAL_CURRENT_CRC (Current cal table corrupt.)	15
a21d	PA_ERROR_CAL_IMPEDANCE_CRC (Impedance cal values corrupt.)	15

**Table 5.13—Initial Character a, Therapy Service Codes (TH)**

Code	Service Code Description	Corrective Action Code
a21e	PA_ERROR_CAL_Z_0 (Impedance 0 calibration failed.)	15
a21f	PA_ERROR_PACE_I (Current present when not pacing.)	15
a220	PA_ERROR_NO_HVIS_SENSE (No HV present when pacing.)	15
a221	PA_ERROR_EXT_A2D_TEST (External A/D test register reset failed.)	15
a222	PA_ERROR_NO_CAL_HVIS_SENSE (No HV present before current cal.)	15
a223	PA_ERROR_NO_Q4_SENSE (No Q4 sense when not pacing [Q4 shorted].)	15
a224	PA_ERROR_Q4_SENSE (Q4 sense present when pacing [CR25 open].)	15
a300	TH_PC_ERROR_WDT_TEST (Paddle Control Hardware failure)	6
a301	TH_PC_ERROR_STACK_TEST (Paddle Control Hardware failure)	6
a302	TH_PC_ERROR_RAM_TEST (Paddle Control Hardware failure)	6
a303	TH_PC_ERROR_FLASH_CRC_TEST (Paddle Control Hardware failure)	6
a304	TH_PC_ERROR_J23_DISCONNECTED (Paddle Control Hardware failure)	5
a305	TH_PC_ERROR_OVER_CURRENT (Paddle Control Hardware failure)	4
a306	TH_PC_ERROR_3V_MON (Paddle Control Hardware failure)	6
a307	TH_PC_ERROR_MSG_CRC (Paddle Control Comm failure)	6

**Table 5.13—Initial Character a, Therapy Service Codes (TH)**

Code	Service Code Description	Corrective Action Code
a309	TH_PC_ERROR_MSG_SEQUENCING (Paddle Control Comm failure)	6
a30a	TH_PC_ERROR_UNEXPECTED_WATCHDOG (Paddle Control Hardware failure)	6
a30b	TH_PC_ADC_TIMEOUT (Paddle Control Hardware failure)	6
oxa30d	TH_PC_ERROR_DCO_CAL_CORRUPTED	6
oxa30e	TH_PC_ERROR_OVER_VOLTAGE_RESET	6
a3ff	TH_PC_ERROR_UNKNOWN (Paddle Control Hardware failure)	28
a400	TH_PS_ERROR_WDT_TEST (Paddle Sensing Hardware failure)	6
a401	TH_PS_ERROR_STACK_TEST (Paddle Sensing Hardware failure)	6
a402	TH_PS_ERROR_RAM_TEST (Paddle Sensing Hardware failure)	6
a403	TH_PS_ERROR_FLASH_CRC_TEST (Paddle Sensing Hardware failure)	6
a404	TH_PS_ERROR_POWER_MON (Paddle Sensing Hardware failure)	6
a405	TH_PS_ERROR_MSG_CRC (Paddle Sensing Comm failure)	6
a407	TH_PS_ERROR_MSG_SEQUENCING (Paddle Sensing Comm failure)	6
a408	TH_PS_ERROR_IMPEDANCE_CAL (Paddle Sensing Hardware failure)	6
a409	TH_PS_ERROR_IMPEDANCE_CAL_(CRC Paddle Sensing Hardware failure)	6

**Table 5.13—Initial Character a, Therapy Service Codes (TH)**

Code	Service Code Description	Corrective Action Code
a40a	TH_PS_ERROR_ADC_TIMEOUT (Paddle Sensing Hardware failure)	6
a40b	TH_PS_ERROR_UNEXPECTED_WATCHDOG (Paddle Sensing Hardware failure)	6
a40c	TH_PS_ERROR_RESERVED_1 (Paddle Sensing Hardware failure)	6
a40d	TH_PS_ERROR_ECG_SELF_TEST (Paddle Sensing Hardware failure)	6
a40e	TH_PS_ERROR_Z1_SELF_TEST (Paddle Sensing Hardware failure)	6
a40f	TH_PS_ERROR_Z2_SELF_TEST (Paddle Sensing Hardware failure)	6
a410	TH_PS_ERROR_M1_SELF_TEST (Paddle Sensing Hardware failure)	6
a411	TH_PS_ERROR_M2_SELF_TEST (Paddle Sensing Hardware failure)	6
a4ff	TH_PS_ERROR_UNKNOWN (Paddle Sensing Hardware failure)	28
a500	TH_ED_ERROR_WDT_TEST (Energy Delivery Hardware failure (Watchdog failure))	6
a501	TH_ED_ERROR_STACK_TEST (Energy Delivery Hardware failure (Stack check fault))	6
a502	TH_ED_ERROR_RAM_TEST (Energy Delivery Hardware failure (RAM test fault))	6
a503	TH_ED_ERROR_FLASH_CRC_TEST (Energy Delivery Hardware failure (ROM test fault))	6
a504	TH_ED_ERROR_3_3_V_MON (Energy Delivery Hardware failure (3.3V monitor voltage out of tolerance))	6
a505	TH_ED_ERROR_24_V_MON (Energy Delivery Hardware failure (24V monitor voltage out of tolerance))	6

**Table 5.13—Initial Character a, Therapy Service Codes (TH)**

Code	Service Code Description	Corrective Action Code
a506	TH_ED_ADC_TIMEOUT (Energy Delivery Hardware failure (ADC read failure))	6
a507	TH_ED_ERROR_OSCILLATOR (Energy Delivery Hardware failure (ED oscillator fault, ED switches to the internal DCO clock))	6
a508	TH_ED_ERROR_TEST_XFER_OPEN (Energy Delivery Hardware failure (XFER Engage signal is open when expected to be closed))	6
a509	TH_ED_ERROR_TEST_XFER_CLOSE (Energy Delivery Hardware failure (XFER Engage signal is closed when expected to be open))	6
a50a	TH_ED_ERROR_MSG_CRC (Energy Delivery Comm failure (ED received 3 consecutive messages with CRC failures))	6
a50c	TH_ED_ERROR_SEQUENCING (Energy Delivery Comm failure (ED received 3 consecutive messages out of sequence))	6
a50f	TH_ED_ERROR_CAP_OVER_VOLTAGE (Energy Delivery Hardware failure (Cap voltage exceeds maximum))	9
a510	TH_ED_ERROR_CHARGING_TIMEOUT (Energy Delivery Hardware failure (Cap stays CHARGED for 65 seconds))	9
a511	TH_ED_DUMP_TIMEOUT (Energy Delivery Hardware failure (Dump Timeout - Capacitor energy dump to less than 1 joule takes longer than 25 seconds))	9
a513	TH_ED_ERROR_PACE_PULSE_WIDTH (Energy Delivery Hardware failure (Pace pulse width greater than 30ms))	6
a514	TH_ED_ERROR_PACE_CHARGE_TIMEOUT (Energy Delivery Hardware failure (Charge timeout during pacing))	9
a518	TH_ED_ERROR_UNEXPECTED_WATCHDOG (Energy Delivery Hardware failure (Unexpected watchdog reset))	6
a519	TH_ED_ERROR_HTEST (Energy Delivery Hardware failure (H-Bridge test failure))	6
a51a	TH_ED_ERROR_DEFIB_CAL (Energy Delivery Hardware failure (Energy calibration table CRC failure, ED will use default table))	10
a51b	TH_ED_ERROR_ADC_COMPARE (Energy Delivery Hardware failure (VCAP1 and VCAP2 do not match))	6

Table 5.13—Initial Character a, Therapy Service Codes (TH)

Code	Service Code Description	Corrective Action Code
a51c	TH_ED_ERROR_VOLTAGE_ON_CAP (Energy Delivery Hardware failure (Voltage on the CAP when not expected))	9
a51e	TH_ED_ERROR_RELAY_TEST (Energy Delivery/System Control Hardware failure) (1=SYS_XFER_EN line not high or ED_UP_XFR_RLY_EN line not low 2=SYS_XFER_EN line not low or ED_UP_XFR_RLY_EN line not low 3=SYS_XFER_EN line not low or ED_UP_XFR_RLY_EN line not high)	6
a51f	TH_ED_ERROR_OVER_VOLTAGE_RESET	6
a5ff	TH_ED_ERROR_UNKNOWN (Energy Delivery Hardware failure (ED reported an unknown fault ID))	28



## Printer Service Codes

Table 5.14—Initial Character b, Printer Service Codes (PR)

Code	Service Code Description	Corrective Action Code
b001	PR_ERROR_TEMP_TOO_LOW (Printhead ADC reading too low; param = ADC value. May be associated with UT_ERROR_DAC_FAILURE and UT_ERROR_ADC_READ.)	13, 28
b002	PR_ERROR_TEMP_TOO_HIGH (Printhead ADC reading too high; param = ADC value. May be associated with UT_ERROR_DAC_FAILURE and UT_ERROR_ADC_READ.)	13, 28
b003	PR_ERROR_SELF_TEST_FAIL (Invalid CRC read from HW; param = ADC value.)	13, 28
b004	PR_ERROR_WRONG_PRINTER_TYPE (Saw incorrect printer for config; 50/100 mismatch.)	13, 28

## Power Management Service Codes

Table 5.15—Initial Character c, Power Management Service Codes (PM)

Code	Service Code Description	Corrective Action Code
c008	PM_ERROR_LOST_COMMS (Lost communications with power PCB.)	7, 1
c009	PM_ERROR_CLOCK_FAILURE (Power PCB is running on its internal oscillator block because it detected an external clock failure.)	1, 7

### Corrective Action Codes

Corrective action codes are referenced in the service code tables under [Service Log Code Categories \(p. 117\)](#). If more than one action is listed under Description, perform them in the order indicated.

**Table 5.16—Corrective Action Codes**

Corrective Action Code	Description
1	System Communications or System Processing service code: a. Review <a href="#">Processing Service Log Codes</a> section. b. Verify that the appropriate connecting cables and wire harnesses are functional. c. Possible A01 System PCB failure.
2	Real time clock service code: a. Review <a href="#">Processing Service Log Codes</a> section. b. Possible nonvolatile RAM failure on coin battery power on A01 System PCB.
4	Therapy service code: a. Review <a href="#">Processing Service Log Codes</a> section. b. Verify the appropriate connecting cables and wire harnesses are functional. c. Verify the appropriate electrodes connected to paddles connector are functional. d. Verify the paddles connector is not shorted. e. Possible A04 Therapy PCB failure.
5	Therapy service code: a. Review <a href="#">Processing Service Log Codes</a> section. b. Verify the cable is connected properly to J23 Connector at Therapy PCB.

**Table 5.16—Corrective Action Codes (Continued)**

Corrective Action Code	Description
6	Therapy service code: a. Review <a href="#">Processing Service Log Codes</a> section. b. Verify the appropriate connecting cables and wire harnesses are functional. c. Possible A04 Therapy PCB failure.
7	Power Processor service code: a. Review <a href="#">Processing Service Log Codes</a> section. b. Verify the appropriate connecting cables and wire harnesses are functional. c. Possible A03 Power PCB failure.
8	Device manufacturing configuration bit incorrectly set: (Physio-Control service required). a. Review <a href="#">Processing Service Log Codes</a> section. b. Possible nonvolatile RAM failure on A01 System PCB.
9	Therapy Energy Delivery Capacitor service code: a. Review <a href="#">Processing Service Log Codes</a> section. b. Verify the appropriate connecting cables and wire harnesses are functional. c. Possible A04 Therapy PCB failure. d. Possible Defib Cap (A15) failure.
10	Defibrillator Energy service code: a. Complete the procedure, and then conduct Performance Inspection Procedures (PIP). b. Verify the appropriate connecting cables and wire harnesses are functional. c. Possible A04 Therapy PCB failure.

**Table 5.16—Corrective Action Codes (Continued)**

Corrective Action Code	Description
11	Configuration or keypad service code: a. Check device configuration settings against installed hardware. b. Review <a href="#">Processing Service Log Codes</a> section. c. Possible A09 Printer Control Keypad or A10 Main Keypad failure. d. Possible A01 System PCB or A04 Therapy PCB failure. e. Verify the appropriate connecting cables and wire harnesses are functional.
13	Printer service code: a. Review <a href="#">Processing Service Log Codes</a> section. b. Possible A12 Printer Assembly failure. c. Verify the appropriate connecting cables and wire harnesses are functional.
15	Pacer service code: a. Review <a href="#">Processing Service Log Codes</a> section. b. Verify the appropriate connecting cables and wire harnesses are functional. c. Possible A04 Therapy PCB failure.
19	Dump service code (a02c): a. Review <a href="#">Processing Service Log Codes</a> section. b. Verify the appropriate connecting cables and wire harnesses are functional. c. Possible A04 Therapy PCB failure. d. Possible A01 System PCB failure.
20	ECG service code: a. Review <a href="#">Processing Service Log Codes</a> section. b. Verify the appropriate connecting cables and wire harnesses are functional. c. Possible A01 System PCB failure.

Table 5.16—Corrective Action Codes (Continued)

Corrective Action Code	Description
28	The current device software version is recommended, contact Physio-Control Field Service (see <a href="#">Service Information (p. 19)</a> ).
31	Clear Data Management memory.

## Service LED

### What the Service LED Does

The Service LED illuminates when a service code is written to the Service Log. Always examine such instances using the instructions in [Processing Service Log Codes \(p. 113\)](#).

### What the Service LED Does Not Do

The Service LED is not used to indicate the presence of service codes in the Service Log, rather it is used to indicate when service codes are written to the Service Log. For example, if the Service LED illuminates when you turn on the device, it indicates that a service code was written to the Service Log. If you turn the device OFF and then ON again and the Service LED does not illuminate, it does not indicate that there are no service codes in the Service Log. You still must review the Service Log and resolve what was written there in the first instance.

### Display Pixels Test

- ◆ To troubleshoot LCD display viewing issues:
  1. Enter the Service mode (see [Entering Service Mode \(p. 93\)](#)) and select TESTS.
  2. Select PIXELS in the Service/Tests submenu. The LCD display changes to a uniformly lit screen of medium contrast.
  3. Carefully examine the screen for any anomalies. Rotate the SPEED DIAL to examine each color display on the screen.
  4. Press SPEED DIAL to end the test and return to the Service/Tests submenu.
  5. Turn the device OFF or navigate to other service options, as required.

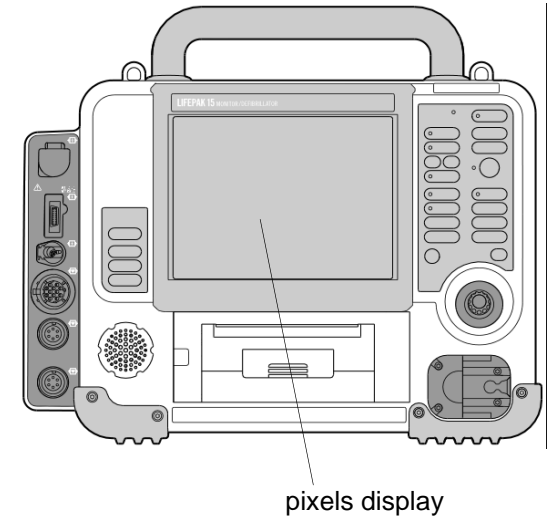



## Preventive Maintenance

Periodic maintenance, inspection, and testing of the device help prevent and detect possible electrical and mechanical problems.

For information about battery charging, conditioning, and battery-related topics, see [Battery Maintenance \(p. 161\)](#). The information in this section includes the following:

- [Device Self Tests \(p. 148\)](#)
- [Device User Test \(p. 149\)](#)
- [Preventive Maintenance and Testing Schedule \(p. 150\)](#)
- [Scheduled Replacement Items \(p. 151\)](#)
- [Setting/Resetting the Maintenance Prompt Interval \(p. 152\)](#)
- [Device Useful Life \(p. 153\)](#)
- [Support Policy \(p. 154\)](#)
- [Cleaning \(p. 155\)](#)
- [Environmental Conditions \(p. 158\)](#)
- [A12 Printer Maintenance \(p. 159\)](#)

## Device Self Tests

### Device Self Test

When you turn on the LIFEPAK 15 monitor/defibrillator, a series of self-tests occur. If service codes are detected, the [Service LED \(p. 145\)](#) illuminates. Self-testing does not occur only when the device is turned ON; rather, it is continuous, repeating over and over again while the device is on.

### Device Auto Test

The device performs an automatic self-test daily at 03:00 (3:00 A.M.), if not in use. During the automatic self-test, the defibrillator turns itself on (ON LED illuminates) briefly and completes the following tasks:

- Performs a self-test
- Stores the self-test results in the test log and prints report
- Turns itself off

The device can also automatically transmit self-test results. LIFENET asset management is required to view transmitted auto test data. For information about enabling transmission of test results, see the *LIFEPAK 15 Monitor/Defibrillator Setup Options* guide provided with the device.

If the defibrillator detects a problem during an auto test, it annotates the fault condition on the printed test report.

The automatic self-test is not performed if the defibrillator is already turned on at 03:00 or if batteries are not installed. If the defibrillator is manually turned on while a self-test is in progress, the self-test is halted and the defibrillator turns on normally.

## Device User Test

### Device User test

When you use the SPEED DIAL to navigate to Options/User Test, the device waits until the next self-test cycle is complete. The user test performs the following tasks:

- Performs a self-test
- Charges the defibrillation capacitor to 10 joules, then dumps the charge
- Stores the test results in the test log
- Displays User Test results and prints report

If this operation does not pass, the Service LED illuminates and a service code is written to the [Service Log \(p. 111\)](#).

### Preventive Maintenance and Testing Schedule

Table 6.1 shows the schedule for preventive maintenance activities (see the *Operator's Checklist* in the operating instructions for additional items). For items that should be replaced at regular intervals, see [Scheduled Replacement Items \(p. 151\)](#).

**Table 6.1—Schedule for Maintenance and Testing**

Activity	Daily	As Needed	12 Months
Performance Inspection Procedures (PIP)		•	•
Test and Calibration Procedures (TCP)		•	
Performance Inspection Procedures (PIP)— Exterior Physical Inspection	•		•
<a href="#">External Cleaning Procedure (p. 156)</a>		•	•

### Scheduled Replacement Items

The following items should be replaced at regular intervals because of their finite life span:

- **Disposable Electrodes**—Replace electrodes by the  “Use by” date.
- **ECG cable (3-lead/5-wire/12-lead)**—Replace to ensure the continued performance of this cable.
- **Lithium-ion battery pak**—Replace to ensure maximum operating time of the device.
- **Coin battery**—Replace to ensure the device will not lose battery power for the real-time clock.

**NOTE:** Contact your Physio-Control Service Representative for assistance when coin battery replacement is required

The following item shall be replaced at regular intervals because of their finite life span:

- **Battery Pins**—Recommended replacement every year, but shall not exceed two years.

Table 6.2 shows the schedule for replacement items.

**Table 6.2—Replacement Schedule**

Replacement Item	Frequency
Replace ECG cable	2 years
Replace battery pins	1-2 years
Replace battery pak	2 years
Replace coin (clock) battery	5 years

### Setting/Resetting the Maintenance Prompt Interval

The MAINTENANCE DUE message can be set up to appear at selected intervals (3, 6, or 12 months). When this time interval is reached, the message appears continuously for 10 minutes each time the device is turned on.

After completing a scheduled maintenance, reset the maintenance prompt interval timer to clear the MAINTENANCE DUE message and begin the count for the next scheduled maintenance.

- ◆ To change the scheduled maintenance interval:
  1. Enter Service mode as described in [Entering Service Mode \(p. 93\)](#).
  2. Select MAINT PROMPT to display the Service/Maint Prompt submenu, which shows the NEXT PROMPT date for scheduled maintenance.
  3. Select INTERVAL.
  4. Select the desired interval. The factory default setting is OFF.
- ◆ To clear the MAINTENANCE DUE message after scheduled maintenance is completed:
  1. Select RESET on the Service/Maint Prompt submenu. The NEXT PROMPT date is revised to the new scheduled maintenance date.
  2. Turn the device OFF.

## Device Useful Life

During product development, the LIFEPAK 15 monitor/defibrillator and subassemblies are subjected to rigorous life-testing. The routine testing and maintenance program recommended in this service manual will help provide reliable device operation for many years. However, both rapid technological changes and the availability of replacement parts limit the useful life of all modern medical devices. The American Hospital Association suggests a five-year useful life expectancy for defibrillators (*Estimated Useful Lives of Depreciable Hospital Assets, Revised 1993 Edition*). Similarly, the US Army lists an eight-year life expectancy for defibrillators (technical bulletin: *Maintenance Expenditure Limits for Medical Materiel, TB MED 7 Revision 8 October 1993*).

### Support Policy

Physio-Control provides full technical support and replacement parts for a period of eight years from the date of shipment from our manufacturing facility. After this eight-year period, Physio-Control provides technical support and replacement parts on an as-available basis.



## Cleaning

### Tools and Materials

The tools and materials needed to perform an external cleaning of the LIFEPAK 15 monitor/defibrillator are listed in [Table 6.3](#).

**Table 6.3—Cleaning Tools and Materials**

Product	Description
Static-discharge-protected work area	Grounded conductive surface and wrist strap
Isopropyl alcohol	
Soap and water	
Quaternary ammonium compounds	
Peroxide (peracetic acid) solutions	
Cotton swabs	
Vacuum cleaner	
Soft-bristle brush	Nonmetallic
Cloth	Clean and lint-free
Compressed air	Clean and dry (60 psi, max.)

### External Cleaning Procedure

#### WARNING

**SHOCK OR FIRE HAZARD** Do not immerse or soak any portion of this device in water or any other fluid. Avoid spilling any fluid on the device or accessories.

#### CAUTION

**POSSIBLE CASE DAMAGE** Do not clean any part of this device or accessories with bleach, bleach dilution, or phenolic compounds. Do not use abrasive or flammable cleaning agents. Do not attempt to sterilize this device or any accessories unless otherwise specified in the accessory operating instructions.

Clean the exterior of the device by wiping the surface with any of the following solutions:

- Soap and water
- Quaternary ammonium compounds
- Isopropyl alcohol
- Peroxide (peracetic acid) solutions

### CO2 Input Cleaning Procedure

If CO2 readings do not appear when a new FilterLine is screwed all the way into the CO2 input, the input connector may need to be cleaned.

Clean the threads on the inside surface of the CO2 input using compressed air supplied in a can with a nozzle. The compressed air should be used only on the outer of the two rings on the inside surface of the port. The inner ring and interior of the inner ring should not be cleaned.

Clean here

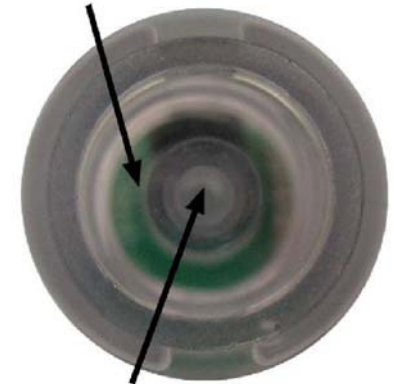

Do not clean here

## Environmental Conditions

### Operating Conditions

Maintain the following operating temperatures when the device is in use:

- 32° to 113°F (0° to 45°C)
- -4°F (-20°C) for 1 hour after storage at room temperature
- 140°F (60°C) for 1 hour after storage at room temperature

Maintain the following relative humidity when the device is in use:

- 5 to 95%, non-condensing
- NIBP: 15 to 95%, non-condensing

### Storage Conditions

When the device is not in use, store as follows:

- -4° to 149°F (-20° to 65°C), except therapy electrodes and batteries

Maintain the following relative humidity when the device is in storage:

- 10 to 95%, non-condensing

## A12 Printer Maintenance

### Print Roller Cleaning

To remove paper debris and other residue from the print roller, soak a cotton swab with alcohol and wipe across the roller surface.

### Printhead Cleaning

Clean the printhead after using approximately 100 rolls of chart paper, or more often if needed. Use a cotton swab soaked in clean isopropyl alcohol.

1. Turn the device OFF. Locate the printhead between the two brushes on the upper half of the printer.
2. Wipe the surface of the printhead clean with the alcohol-soaked cotton swab, allowing only the cotton tip of the swab to contact the printhead.

### Paper Sensor Cleaning

The paper sensor also requires periodic cleaning to prevent paper debris from blocking the infrared signals that reflect off the paper during normal operation.

Clean the sensor whenever the printhead is cleaned. Use a clean cotton swab soaked in clean isopropyl alcohol. Gently wipe the surface of the paper sensor with the tip of the swab.

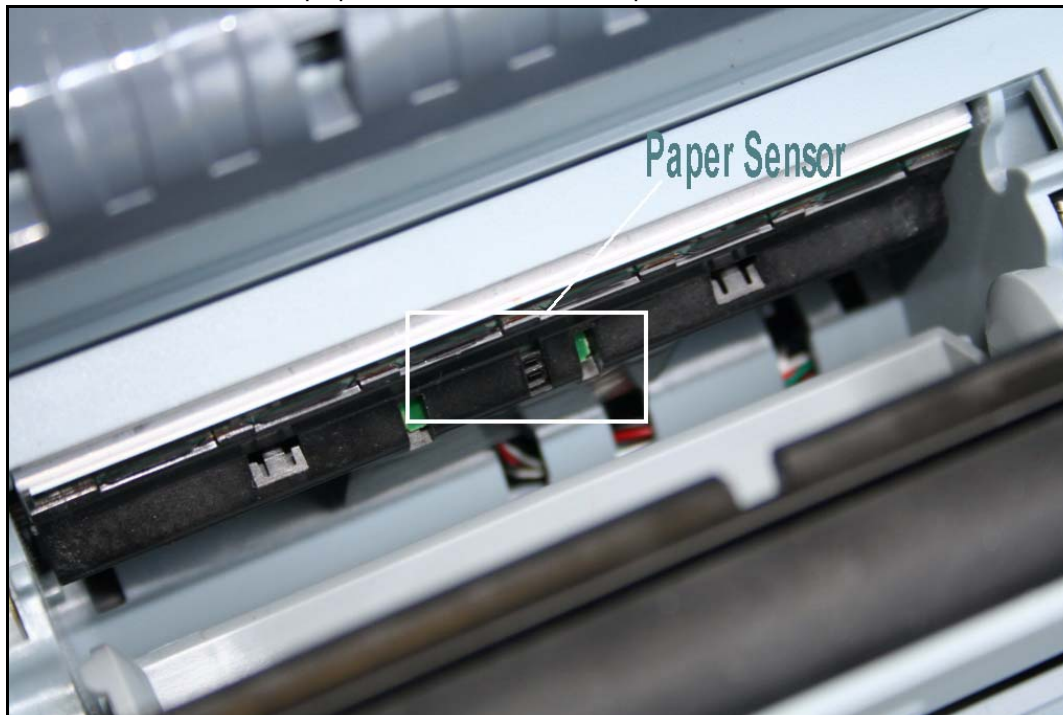

Figure 6.1—Paper sensor

## Battery Maintenance

Follow the guidelines described in this section to help maximize battery life and performance.

- [Battery General Characteristics \(p. 162\)](#)
- [Battery Status Indicators \(p. 163\)](#)
- [Battery Fuel Gauge \(p. 164\)](#)
- [Battery Performance Characteristics \(p. 166\)](#)
- [Charging the Batteries Using the Station or Mobile Li-ion Battery Charger \(p. 167\)](#)
- [Discarding/Recycling Batteries \(p. 168\)](#)
- [Storing Batteries \(p. 169\)](#)
- [Receiving New Batteries \(p. 170\)](#)
- [Coin Cell Battery \(p. 171\)](#)

For information about the LIFEPAK 15 monitor/defibrillator Li-ion battery chargers, see the *Station and Mobile Lithium-ion Battery Chargers Instructions for Use* (REF 26500-002904 or 26500-003136), or see the *REDI-CHARGE, AC Battery Charger Instructions for Use* (REF 26500-003146).

### Battery General Characteristics

#### WARNING

**POSSIBLE LOSS OF POWER DURING PATIENT CARE** Physio-Control has no information regarding the performance or effectiveness of its LIFEPAK monitor/defibrillators if other manufacturers' batteries or battery chargers are used. Using other manufacturers' batteries or battery chargers may cause the device to perform improperly and invalidate the safety agency certifications. Use only Physio-Control LIFEPAK 15 monitor/defibrillator batteries (REF 21330-001176 ) and the appropriate Physio-Control LIFEPAK 15 monitor/defibrillator battery charger.

The device is powered by two LIFEPAK 15 Lithium-ion (Li-ion) rechargeable batteries.

The battery communicates through contacts located on the bottom of the battery, allowing the exchange of information about battery type, amp hours rating, charge rate, target voltage, current, and other parameters. See "Battery Maintenance" in the operating instructions for additional information about the LIFEPAK 15 monitor/defibrillator Li-ion battery maintenance.

**NOTE:** The LIFEPAK 15 monitor/defibrillator Lithium-ion batteries, battery chargers, and power cords are not interchangeable with batteries, battery chargers, and power cords used in other LIFEPAK defibrillators.

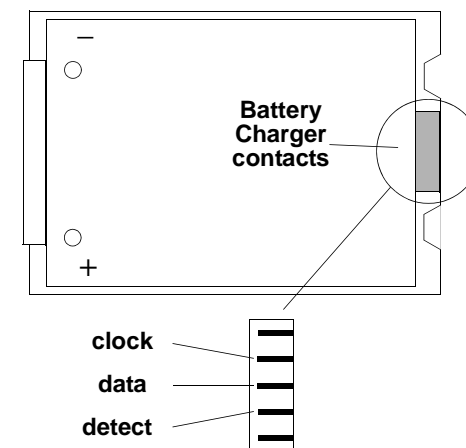



## Battery Status Indicators



### Home Screen

The Home Screen displays battery indicators that show the following information about the batteries installed in the device:



- Presence or absence of battery in battery well
- Battery in use
- Battery charge state

When two batteries are installed, the device uses the battery with the lowest level of charge first. The battery in use is indicated by a white battery number in a black box. When a battery reaches the “replace battery” state, the device automatically switches to the other battery. [Table 7.1](#) provides a description of the various battery status indicators.

**Table 7.1—Battery Status Indicator**

Indicator	Meaning	Description
	Active battery	The device is using the battery in Well 1 for power. Battery status indicators display up to four green bars. Each green bar represents approximately 25% remaining charge. For example, three green bars indicate about 75% remaining charge.
	Low battery	Battery in Well 1 is in use and is low. One yellow bar indicates 5% to 10% remaining charge.
	Very low battery	Battery in Well 1 is in use and is very low. One red flashing bar indicates 0% to 5% remaining charge. The device automatically switches to the other battery only if adequate charge is available. If both batteries show red bars, the REPLACE BATTERY voice prompt occurs.

**Table 7.1—Battery Status Indicator (Continued)**

Indicator	Meaning	Description
	Unrecognized battery	Battery in Well 2 is not in use. Battery communication failed or a non-Physio-Control battery is installed. The battery may power the device, but the level of charge is unknown and low battery messages and prompts will not occur.
	No battery installed or fault detected	No battery is installed in Well 1, or a fault was detected in the battery in Well 1 and the device will not use the battery.

When all battery capacity is exhausted, the device turns OFF. If you insert a fresh battery and repower the device in less than 30 seconds, the device retains its settings. For more information, see [Battery Performance Characteristics \(p. 166\)](#).

### Battery Fuel Gauge

The LIFEPAK 15 Li-ion battery has a pushbutton fuel gauge and the ability to communicate with the Li-ion battery charger.

The pushbutton fuel gauge provides a visual indication of battery capacity and battery condition through a series of four green LEDs. Pressing this button illuminates the LEDs in one of the following patterns:

The displayed battery fuel gauge shows four levels of stored energy as shown in the following table:

**Table 7.2—Fuel gauge indicator**

# Fuel Gauge LEDs	Absolute State of Charge (ASOC)	Messaging/Comments
4 green	75% < ASOC	None
3 green	50% < ASOC	None
2 green	25% < ASOC	None
1 green	15% < ASOC	None

Table 7.2—Fuel gauge indicator (Continued)

# Fuel Gauge LEDs	Absolute State of Charge (ASOC)	Messaging/Comments
1 yellow	$5\% < \text{ASOC}$	LOW BATTERY Charge the battery (see <a href="#">Charging the Batteries Using the Station or Mobile Li-ion Battery Charger (p. 167)</a> )
1 flashing red	$\text{ASOC} \leq 5\%$	REPLACE BATTERY Charge the battery (see <a href="#">Charging the Batteries Using the Station or Mobile Li-ion Battery Charger (p. 167)</a> )

### Battery Performance Characteristics

The following factors affect Li-ion battery performance:

- **Temperature**
  - ~ AC input: Charge batteries at a temperature range of 10° to 40°C (50° to 104°F).
  - ~ DC input: Charge batteries at a temperature range of 5° to 50°C (41° to 122°F) (Mobile charger only).
  - ~ Store batteries at the recommended temperature range of 20° to 25°C (68° to 77°F). Lower temperatures within the recommended range reduce the battery self-discharge rate and increase battery life.

#### CAUTION

**POSSIBLE BATTERY DAMAGE** The Li-ion battery charger will not charge batteries if the temperature is below 0°C or above 50°C.

Table 7.3 provides the performance characteristics of the LIFEPAK 15 Li-ion batteries (at 20°C).

**Table 7.3—Li-ion Battery Characteristics**

Operating Mode		Monitoring Minutes	Pacing (Minutes)	Defibrillation (360 J Discharges)
Total Capacity to Shutdown	Typical (20°C)	360	340	420
	Minimum (20°C)	340	320	400
Capacity After LOW BATTERY Message	Typical (20°C)	21	20	30
	Minimum (20°C)	12	10	6

### Charging the Batteries Using the Station or Mobile Li-ion Battery Charger

#### WARNING

**POSSIBLE LOSS OF POWER AND DELAY OF THERAPY DURING PATIENT CARE** Using an improperly maintained battery to power a defibrillator may cause power failure without warning. Use the appropriate equipment to charge batteries.

LIFEPAK 15 monitor/defibrillator batteries are charged in the Physio-Control station or Mobile Li-ion Battery Charger. The typical charge time for a fully depleted LIFEPAK 15 Li-ion battery is 4 hours and 15 minutes. To maximize performance and battery life, maintain an ambient temperature for the Li-ion battery charger between 20° and 25°C (68° and 77°F) when charging a LIFEPAK 15 Li-ion battery.

◆ To charge a LIFEPAK 15 Li-ion battery in the battery charger:

**NOTE:** When charging for the first time, remove the Charge Before Use label prior to placing the battery in the charger.

1. Place the battery in an open charging bay. The green LED starts blinking to indicate it is charging.
2. Remove the charged battery when the green LED stops blinking and remains illuminated, indicating that it is ready.

**NOTE:** If the red LED illuminates, remove the battery and discard/recycle (see [Discarding/Recycling Batteries \(p. 168\)](#)).

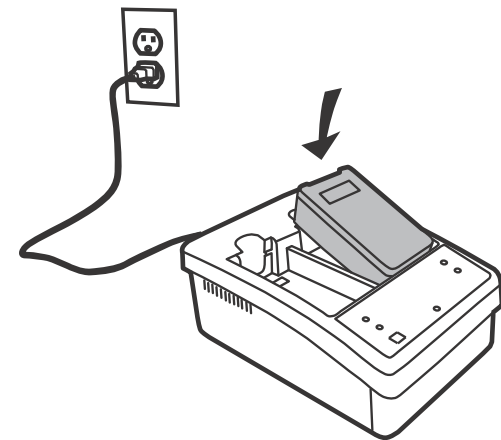

### Discarding/Recycling Batteries

A properly maintained LIFEPAK 15 Li-ion battery should have a useful life of at least two years, although internal parameters will establish useful battery life. You should discard/recycle a LIFEPAK 15 Li-ion battery under any of the following conditions:

- There is physical damage to the battery case.
- The Li-ion battery charger indicates a battery fault (solid red LED) during a charging cycle.
- The battery fuel gauge indicates two or fewer green LED bars after the battery completes a charge cycle.

Recycle batteries locally according to national, regional, and local governmental regulations. For instructions on disposing of batteries, see [www.physio-control.com/recycling](http://www.physio-control.com/recycling).

If recycling is not possible, contact a Physio-Control representative for information or assistance. In the U.S., call 1.800.442.1142.

To promote awareness of battery recycling, batteries are marked with one of these symbols:



## Storing Batteries

### WARNING

**POSSIBLE LOSS OF POWER DURING PATIENT CARE** Stored batteries lose charge. Failure to charge a battery before use may cause device power failure without warning. Always charge a stored battery before placing it in use.

A battery is considered to be in storage when it is not in active use.

LIFEPAK 15 Li-ion batteries require special handling procedures for storage and then placing in use.

- Storage temperatures ranges:
  - ~ Short term (<1 week): -20° to 60°C (-4° to 140°F)
  - ~ Long term (>1 week): 20° to 25°C (68° to 77°F)
- Operating and storage humidity range: 5% to 95% relative humidity, non-condensing
- Fully charge LIFEPAK 15 Li-ion batteries before storing, and at least annually while in storage.
- Do not freeze batteries. Damage to the battery may result.
- Charge stored batteries before placing in use.

### Receiving New Batteries

#### WARNING

**POSSIBLE LOSS OF POWER DURING PATIENT CARE** New batteries may not be fully charged. Failure to charge a battery before use may cause device power failure without warning. Always charge a new battery before placing it in use.

When you receive new batteries, charge each new battery prior to placing in use (see [Charging the Batteries Using the Station or Mobile Li-ion Battery Charger \(p. 167\)](#)).



### Coin Cell Battery

The coin cell battery, REF 21300-001052 (type CR2032), powers the device real-time clock and user-configured settings (custom events and ECG lead sets). The coin cell battery should be replaced every five years.

Preserve the existing Setup Options prior to replacing the coin cell battery. See details in [Setup Mode \(p. 90\)](#).

For Coin Cell Battery replacement (see [Coin Battery Replacement \(p. 348\)](#)).

## Replacement Procedures

The replacement procedures are a set of detailed instructions for disassembly, handling, and reassembly of replaceable LIFEPAK 15 monitor/defibrillator parts. Perform an interior inspection whenever the LIFEPAK 15 monitor/defibrillator case is opened for service. When disconnecting cables and wire harnesses, label the cables and connections so that they match easily during reassembly, for example, J01, J03, and so forth. See the [Interconnect diagram with detailed assembly, cable interconnect information, and links to each part diagram with power PCB \(REF 21330-001531\)](#). (p. 356) for additional information.

Before replacing any parts, review the following items:

- [Summary of Replacement Procedures \(p. 173\)](#)
- [Warnings and Cautions \(p. 176\)](#)
- [Static-Sensitive Device Handling \(p. 177\)](#)
- [Tools List \(p. 179\)](#)
- [Capacitor Discharge Tool \(p. 180\)](#)
- [Capacitor Discharging Procedure \(p. 181\)](#)
- [Saving and Restoring the Setup Configuration \(p. 182\)](#)
- [Disassembling the Case \(p. 183\)](#)
- [Reassembling the Case \(p. 186\)](#)
- [Inside Front Case Diagram \(p. 191\)](#)
- [Software and Device Upgrades \(p. 351\)](#)

### Summary of Replacement Procedures

Replacement procedures are referenced and linked in the inside front case diagram (see [Inside Front Case Diagram \(p. 191\)](#)) and inside rear case diagrams (see [Inside Rear Case Diagrams \(p. 231\)](#)). Most activities start with disassembling the case (see [Disassembling the Case \(p. 183\)](#)).

**NOTE:** The “Procedures” link in the button bar at the bottom of each page returns you to this page to select the appropriate replacement procedure.

**NOTE:** To simplify cable referencing, the cable number only is sometimes used in the replacement procedures. For example, the power/system PCB cable (W01) may be referred to in procedures as the W01 cable.

### Inside Front Case Part Replacement Procedures

Choose from the following inside front case replacement procedures (in alphanumerical order):

- [Backlight PCB \(A08\) Replacement \(p. 197\)](#)
- [Backlight/Interface PCB Cable \(W06\) Replacement \(p. 216\)](#)
- [Display Shield Replacement \(p. 204\)](#)
- [Front Case Replacement \(p. 211\)](#)
- [Interface PCB \(A05\) Replacement \(p. 192\)](#)
- [LCD Display Assembly \(A11\) Replacement \(p. 206\)](#)
- [LCD Display Assembly/Interface PCB Cable \(W18\) Replacement \(p. 229\)](#)
- [Main Keypad \(A10\) Replacement \(p. 202\)](#)
- [Main Keypad/Interface PCB Cable \(W13\) Replacement \(p. 220\)](#)
- [Printer Assembly/Interface PCB Cable \(W16\) Replacement \(p. 224\)](#)
- [Printer Assembly/Chassis Ground Cable \(W19\) Replacement \(p. 230\)](#)
- [Printer Control Keypad \(A09\) Replacement \(p. 200\)](#)
- [Printer Control Keypad/Interface PCB Cable \(W12\) Replacement \(p. 219\)](#)
- [Speaker Assembly \(W17\) Replacement \(p. 226\)](#)
- [Speed Dial Assembly \(W15\) Replacement: \(p. 221\)](#)
- [System/Interface PCB Cable \(W04\) Replacement \(p. 215\)](#)
- [Therapy Connector Cable \(W11\) Replacement \(p. 217\)](#)

### Inside Rear Case Part Replacement Procedures

Choose from the following inside rear case replacement procedures (in alphanumerical order):

- [Battery Pins / Power PCB Cable \(W10\) Replacement \(p. 320\)](#)
- [CO2 Adapter Cable \(W30\) Replacement \(p. 339\)](#)
- [CO2 Inlet Connector Cable \(W28\) Replacement \(p. 336\)](#)
- [ECG Connector Cable \(W07\) Replacement \(p. 314\)](#)
- [Energy Storage Capacitor \(A15\) Replacement \(p. 268\)](#)
- [EMI Shield Replacement \(p. 291\)](#)
- [Invasive Pressure Connector Assembly \(W33\) Replacement \(p. 341\)](#)
- [NIBP \(A21\)/CO2 \(A23\) Module Replacement \(p. 281\)](#)
- [NIBP Connector Replacement \(p. 292\)](#)
- [OEM PCB \(A06\) Replacement \(p. 261\)](#)
- [OEM PCB/CO2 Module Cable \(W26\) Replacement \(p. 332\)](#)
- [OEM PCB/NIBP Module Cable \(W27\) Replacement \(p. 334\)](#)
- [OEM PCB/SpO2 \(W21\) Module Cable Replacement \(p. 327\)](#)
- [Parameter Bezel Replacement \(p. 295\)](#)
- [Power/Contact PCB Cable \(W05\) Replacement \(p. 312\)](#)
- [Power PCB \(A03\) Replacement \(p. 250\)](#)
- [Power/System PCB Cable \(W01\) Replacement \(p. 309\)](#)
- [Power/Therapy PCB Cable \(W02\) Replacement \(p. 310\)](#)
- [Rear Case Replacement \(p. 301\)](#)
- [SpO2 Connector Cable \(W22\) Replacement \(p. 329\)](#)
- [SpO2 PCB \(A16\) Replacement \(p. 271\)](#)
- [System \(A01\)/Therapy \(A04\) PCB Assembly Replacement \(p. 234\)](#)
- [System Connector Cable \(W08\) and Auxiliary Connector Cable \(W09\) Replacement \(p. 317\)](#)
- [Temperature Cable Assembly \(W35\) Replacement \(p. 343\)](#)

### Additional Part Replacement Procedures

Choose from the following procedures (in alphanumerical order) for parts outside the front or rear case.

- [Battery Pin Replacement \(p. 350\)](#)
- [Coin Battery Replacement \(p. 348\)](#)
- [Contact PCB \(A07\) Replacement \(p. 345\)](#)
- [Handle Replacement \(p. 307\)](#)
- [Paddle Retainer Cover Replacement \(p. 308\)](#)
- [Printer Assembly \(A12\) Replacement \(p. 346\)](#)
- [USB Flex Module \(W14\) Replacement \(p. 325\)](#)

### Warnings and Cautions

The following general warnings and cautions apply to all actions you may perform during maintenance of the LIFEPAK 15 monitor/defibrillator.

#### DANGER

**SHOCK HAZARD** Lethal voltages may be present even without operator action. Always discharge the energy storage capacitor prior to servicing. See the service manual "[Capacitor Discharging Procedure \(p. 181\)](#)" for detailed instructions.

#### WARNING

**SHOCK HAZARD** The pacing storage capacitor carries high voltage. Discharge the capacitors before handling.

**POSSIBLE SHOCK AND DEVICE DAMAGE** It is possible to pinch and damage wires during reassembly. To avoid pinching wires, carefully follow reassembly instructions.

#### CAUTION

**POSSIBLE COMPONENT DAMAGE** The PCBs contain static-sensitive devices (SSDs). To avoid damage, observe the special handling practices in [Static-Sensitive Device Handling \(p. 177\)](#). PCBs contain high impedance circuitry; always handle the PCB by holding on to the edges.

## Static-Sensitive Device Handling

### About SSD Handling

Many electronic semiconductor devices (such as MOS ICs, FETs, optical isolators, or film resistors) can be damaged by the discharge of static electricity. Static charge buildup is very common. Static discharges commonly occur when the operator wears synthetic clothes and transfers the charge to any object touched. These discharges can damage or destroy static-sensitive devices (SSDs). In most cases, the discharge is not even perceptible to the person who causes it.

To prevent static discharge damage to SSDs, observe the following precautions during any open-case test, maintenance, or repair procedures:

### Look for SSD Symbol

SSDs are identified with the following warning symbol:



### Use Static-Dissipative Mat

Always perform repair or maintenance on a static-dissipative mat that is connected to earth ground.

### Wear a Wrist Strap

Always wear a conductive wrist strap connected to the mat and to ground except when working on energized equipment or when discharging high voltage circuits. The strap must be snug enough to make good contact against bare skin.

#### WARNING

**SHOCK HAZARD** Remove the wrist strap when working on energized equipment or when discharging high voltage circuits.

### Transport and Store PCBs Properly

Transport and store PCBs in anti-static racks or inside conductive bags. Label the package containing the PCBs as static-sensitive.

### Keep Work Area Static-Free

Keep static-generating products, such as styrofoam cups or trays, away from the work area. Connect all electrical equipment, such as soldering irons and test equipment, to ground with a three-prong plug.

### Test Work Area Routinely

Test all the anti-static parts of the work area (mat, straps, cables) routinely. Keep a log of the test results.



### Tools List

The suggested list of tools for the LIFEPAK 15 monitor/defibrillator replacement procedures is as follows:

- Static-dissipative mat and wrist strap
- Anti-static rack and/or conductive bags
- Capacitor discharge tool (information about [Capacitor Discharge Tool \(p. 180\)](#))
- Calibrated Torque screwdriver(s)—required torque settings are 2.0, 4.0, 6.8, and 10.0 in-lb

Torque in-lb	2.0	4.0	6.8	10.0
Torque in-oz	32	64	108.8	160
Torque cNm	22.5	45	77	113

- Point 0 power drive bit (P0)- Phillips tip for 2-56 screws
- Point 1 power drive bit (P1)- Phillips tip for 4-40 screws (shaft length of 2" and 6")
- Point 2 power drive bit (P2)- Phillips tip for 6-32 screws (shaft length of 6")
- T10 torx power drive bit
- T15 torx power drive bit
- 4 mm modified thin wall socket for battery pins (Physio-Control tool #3300955)
- 1/4" socket
- 1/2" deep socket
- 9/16" deep socket
- 3/4" modified deep socket (Physio-Control tool #3305448)
- 3/8" nutdriver
- Small, slotted screwdriver for label removal
- Diagonal cutter
- Needle nose pliers
- 1.5" (hard) putty knife
- See PIP–Test Equipment Requirements and TCP–Test Equipment Requirements for additional test tools required for performance testing

### Capacitor Discharge Tool

A capacitor discharge tool is used to discharge the energy storage capacitor (see [Capacitor Discharging Procedure](#) (p. 181)).

#### **DANGER**

**SHOCK HAZARD** Capacitor discharge tools that are not designed and labeled for biphasic use are inadequate for use on biphasic defibrillators and will take several minutes to discharge the energy capacitor.

The illustration shows how the biphasic capacitor discharge tool is constructed. The materials used in this example are:

- 10 k $\Omega$ , 2 W resistor (ten 1 K $\Omega$  2 W), high-voltage
- 5 M $\Omega$ , 5 W resistor, high-voltage
- Neon lamp, NE76, NE2, or NE2H
- 8 AWG copper wire
- Clear plastic tubing, capable of insulating 10 kV
- 10 kV insulation
- RTV silicone rubber sealant

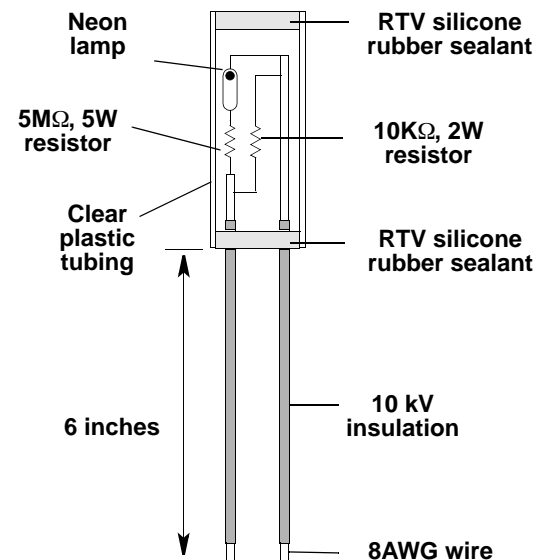

Figure 8.1—Capacitor discharge tool

### Capacitor Discharging Procedure

After disassembling the case as described in [Disassembling the Case \(p. 183\)](#), immediately discharge the energy storage capacitor using the capacitor discharge tool as described in [Using the Capacitor Discharge Tool \(p. 181\)](#). The discharge points are located through holes on the interconnect bracket in the rear case.

#### Using the Capacitor Discharge Tool

- ◆ To use the capacitor discharge tool:
  1. Place one probe on a discharge point and hold it steady.
  2. Place the other probe on the remaining discharge point and hold both probes steady.
  3. Observe the neon lamp inside the capacitor discharge tool. If a charge of approximately 90 volts is present, the neon lamp will light.

#### DANGER

**SHOCK HAZARD** Lethal voltages may be present even without operator action. Do not assume the capacitor is uncharged if the neon lamp does not light! There may still be a charge on the capacitor. Do not touch capacitor terminals until completing the discharge operation.

4. Continue holding the probes on the points indicated for at least 30 seconds after the neon lamp is no longer lit.

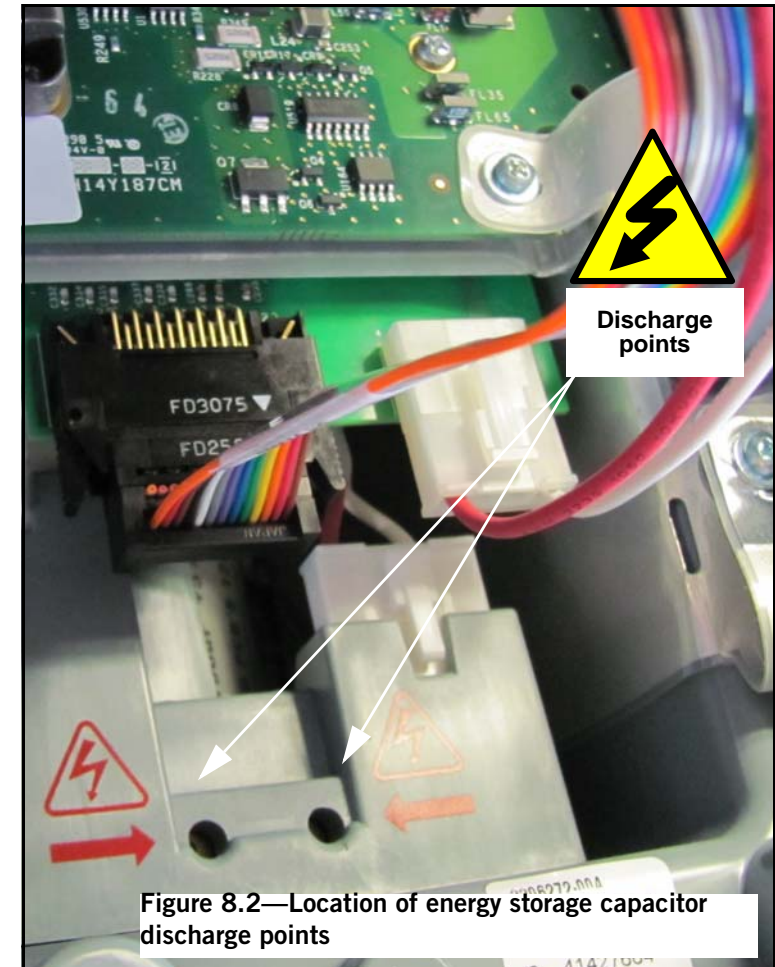

Figure 8.2—Location of energy storage capacitor discharge points

### Saving and Restoring the Setup Configuration

Before beginning any repair action, the existing setup configuration should be preserved using either of the following methods:

- The best method is to store setup options to a computer using the LIFEPAK Defibrillator Software Solutions Configuration Setup Tool before performing service.
- The second method is to print the existing setup configuration, complete repairs, and then manually reconfigure the device.

**NOTE:** The LIFEPAK Defibrillator Software Solutions Configuration Setup Tool is a Windows<sup>®</sup>-based application designed to assist you in managing the setup options in your LIFEPAK 15 monitor/defibrillator. You can download the tool from <http://www.physio-control.com/config.aspx>.

### Printing the Setup Configuration

- ◆ To print the setup configuration:
  1. Display the Setup mode (see [Setup Mode \(p. 90\)](#)).
  2. Select PRINT DEFAULTS to print the device setup configuration. Save this printout for future reference.
  3. Turn the device OFF.

### Restoring the Setup Manually

- ◆ To restore the setup configuration manually:
  1. Display the Setup menu.
  2. Using the printout from the preceding steps, check the settings in each menu and revise as necessary to match the printout. The printout items are organized in the same manner as the Setup menu (General, Manual Mode, AED Mode, and so forth). See the LIFEPAK 15 Monitor/Defibrillator Setup Options instructions provided with your device.
  3. Turn the device OFF.

### Disassembling the Case

Refer to [Front Parts Diagrams and Parts List \(p. 364\)](#) and [Rear Diagrams and Parts List \(p. 386\)](#).

◆ To disassemble the case halves: *12 steps, (Page 1 of 3)*

1. If applicable, remove carrying case.
2. Remove all cables and patient connections, and then remove the batteries.
3. Remove the four front mounting screws from the bumpers.
4. Remove the four rear mounting screws from the bumpers.
5. Remove the bumpers (REF [21300-007356](#) and [21300-007010](#)) from the case and set aside.



Figure 8.3—Bumper screw locations

- ◆ To disassemble the case halves: *(Continued) 12 steps, (Page 2 of 3)*
  6. Lay the defibrillator face-down on a protective surface to prevent damage, and then remove the 14 case screws. Discard the screws.
  7. Holding the case halves together, position the device face-up on your work surface. Lift the front case assembly slightly above the rear to access the connecting cables.

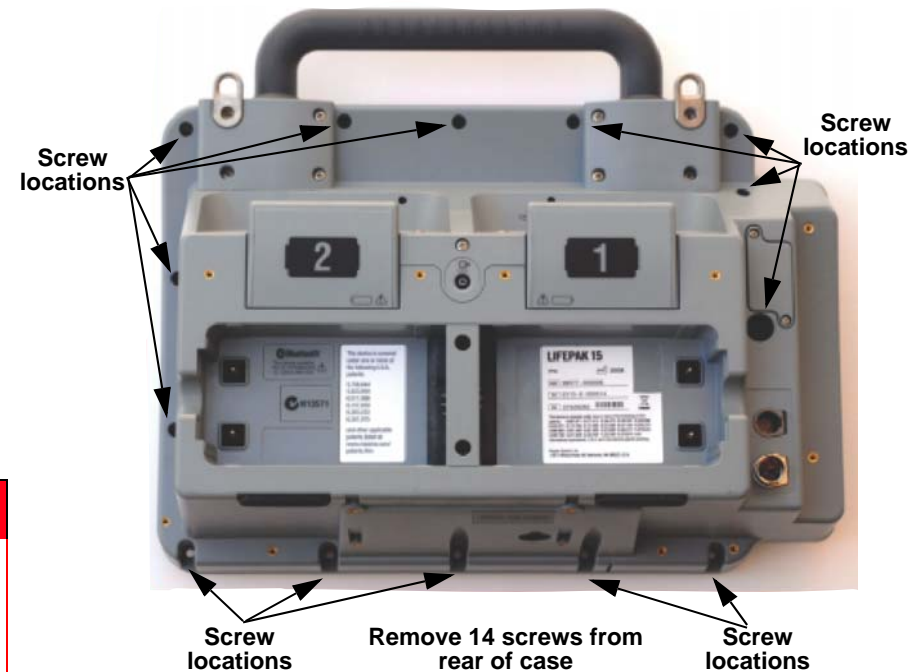

Figure 8.4—Screw locations

### DANGER

**SHOCK HAZARD** Lethal voltages may be present even without operator action. Always discharge the energy storage capacitor prior to servicing. See the service manual “[Capacitor Discharging Procedure \(p. 181\)](#)” for detailed instructions.

- ◆ To disassemble the case halves: *(Continued) 12 steps, (Page 3 of 3)*
  8. Disconnect the P2 system/interface flex cable connector (W04) from the system PCB (see [Figure 9.22 on p. 433](#)) in the rear case.
  9. Before continuing any further, discharge the energy storage capacitor using the discharge tool (see [Capacitor Discharging Procedure \(p. 181\)](#)).
  10. Disconnect the P23 therapy ribbon cable connector (W11) in the front case from the therapy PCB (see [Figure 9.24 on p. 435](#)).
  11. Disconnect the P21 therapy cable connector (W11) from the therapy PCB (see [Figure 9.24 on p. 435](#)).
  12. Separate the front and rear cases halves.

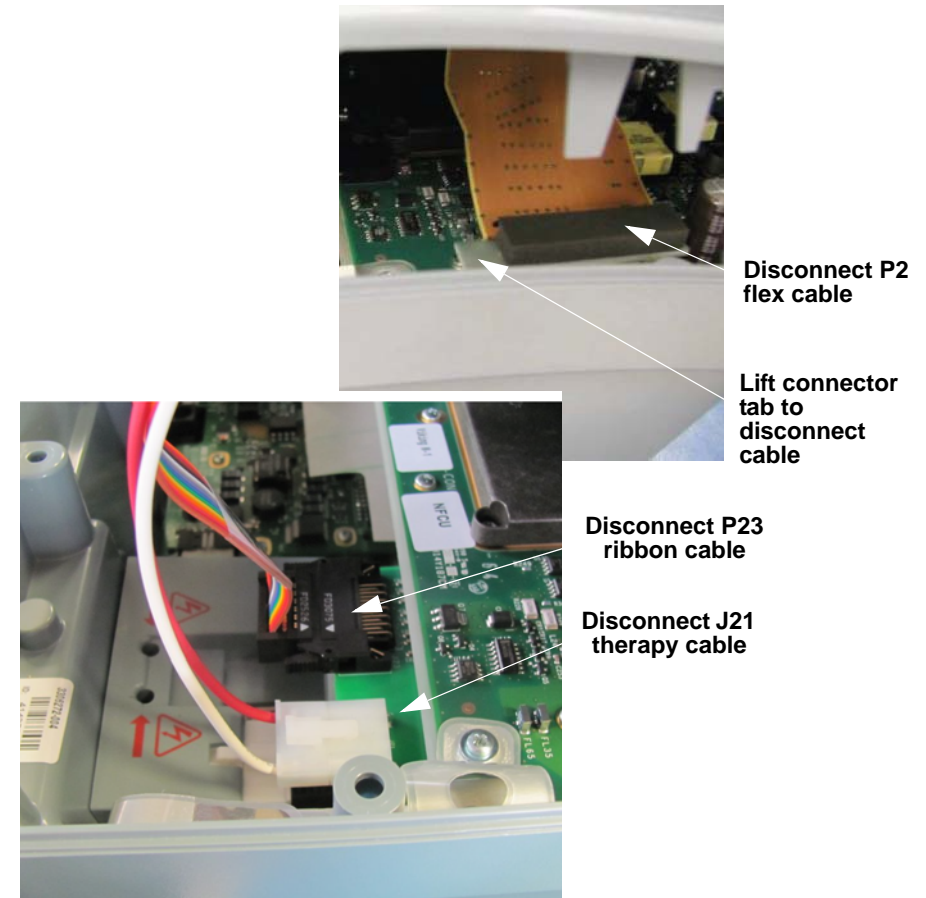
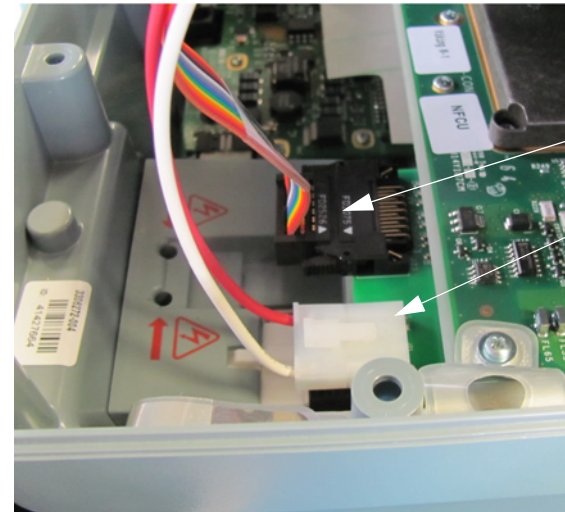

Figure 8.5—Disconnection points

### Reassembling the Case

- ◆ To reassemble the case halves: *13 steps, (Page 1 of 5)*
  1. Position the front case over the rear case.
  2. Connect the P23 therapy ribbon cable connector (W11) (REF [21330-001510](#)) from the front case to J23 of therapy PCB (Figure 9.24 on p. 435).
  3. Connect the J21 2-pin therapy cable connector (W11) to P21 of therapy PCB (Figure 9.24 on p. 435).



Connect P23  
ribbon cable

Connect J21  
therapy cable



◆ To reassemble the case halves: *(Continued) 13 steps, (Page 2 of 5)*

4. Carefully connect the P2 system/interface flex cable connector (W04) (REF [21330-001226](#)) to the system PCB in the rear case (Figure 9.22 on p. 433).
5. Ensure the case seal is in place in the groove along outside edge of front case. Fold the front and rear case halves together. Route the therapy cable wires away from the edge of the case to avoid pinching.

### CAUTION

**POSSIBLE COMPONENT DAMAGE** - Ensure the therapy cable wires are routed away from the edge of case to avoid wire pinching (see [Figure 8.5 on p. 185](#)).

**POSSIBLE MOISTURE LEAKAGE** - Visually inspect the mating surfaces between the front and the rear case halves before and after fastening them together to ensure that they are even.

**PREVENT VIBRATION DAMAGE** In order to meet vibration specifications (for example, prevent loosening of case screws), use new screws (REF [21300-000777](#)) when assembling the case and torque to specified value.

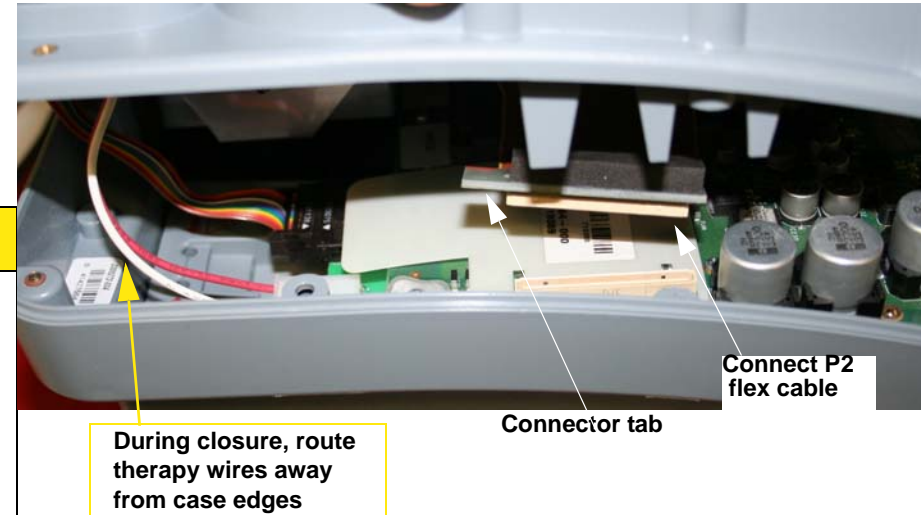

Figure 8.6—Connection points

- ◆ To reassemble the case halves: *(Continued) 13 steps, (Page 3 of 5)*
  6. Install 14 new screws (REF [21300-000777](#)); torque to 10.0 in-lb using a P2 bit.

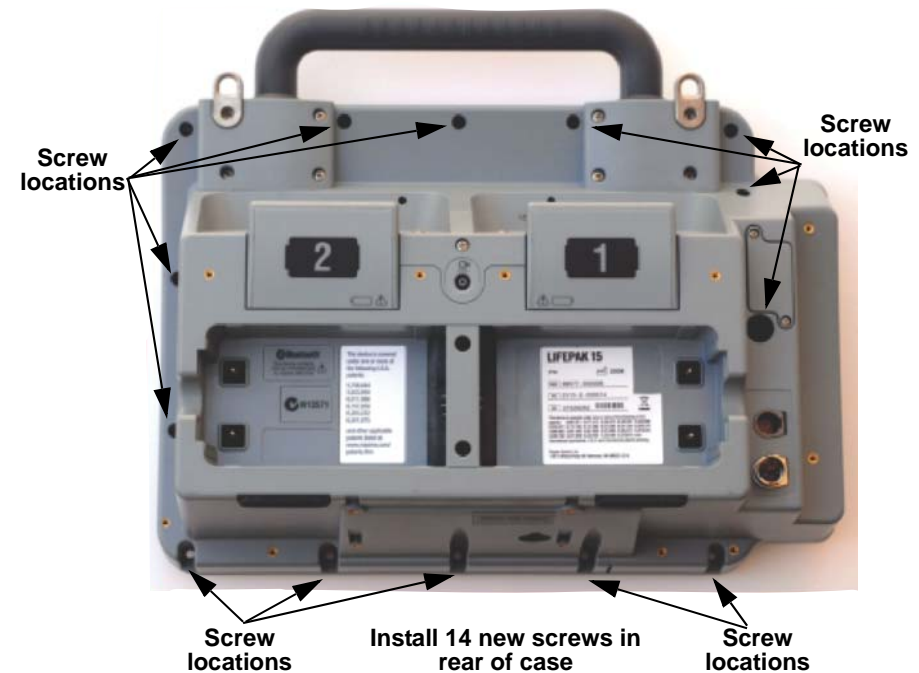

Figure 8.7—Screw locations

◆ To reassemble the case halves: *(Continued) 13 steps, (Page 4 of 5)*

7. Reinstall the right corner bumper (REF [21300-007356](#)) with 4 screws (REF [21300-007253](#)); torque to 10.0 in-lb using Torx T-15 bit.
8. Reinstall the left corner bumper (REF [21300-007010](#)) with 4 screws (REF [21300-007253](#)); torque to 10.0 in-lb using Torx T-15 bit.

**NOTE:** If new bumpers and feet are required, use [Guard & Feet Repair Kit \(REF 40577-000007\)](#).



Figure 8.8—Bumper screw locations

◆ To reassemble the case halves: *(Continued) 13 steps, (Page 5 of 5)*

9. Install the batteries.

**NOTE:** Pay special attention to the **SERVICE** indicator as you turn on the device in the next step.

10. If applicable, reinstall carrying case.

11. Turn the device ON and observe the SERVICE indicator.

- If the SERVICE indicator is OFF, continue with step 12.
- If the SERVICE indicator is ON, skip to step 13.
- If the device gives no indication that power is on, review information in Note below.

12. Complete the Test and Calibration Procedures (TCP), followed by the Performance Inspection Procedures.

13. Error codes have been written to the Service Log. Continue to [Processing Service Log Codes \(p. 113\)](#).

**NOTE:** If there is no indication of power, either the batteries are dead or no batteries are installed, or the W04 cable connection was not made when the case was reassembled. The W04 cable is the flex cable between the front case and rear case. Check the batteries and, if they are charged, disassemble the case as described in [Disassembling the Case \(p. 183\)](#) and check the W04 cable.

### Inside Front Case Diagram

Use the following diagram after disassembling the case as described in [Disassembling the Case \(p. 183\)](#).

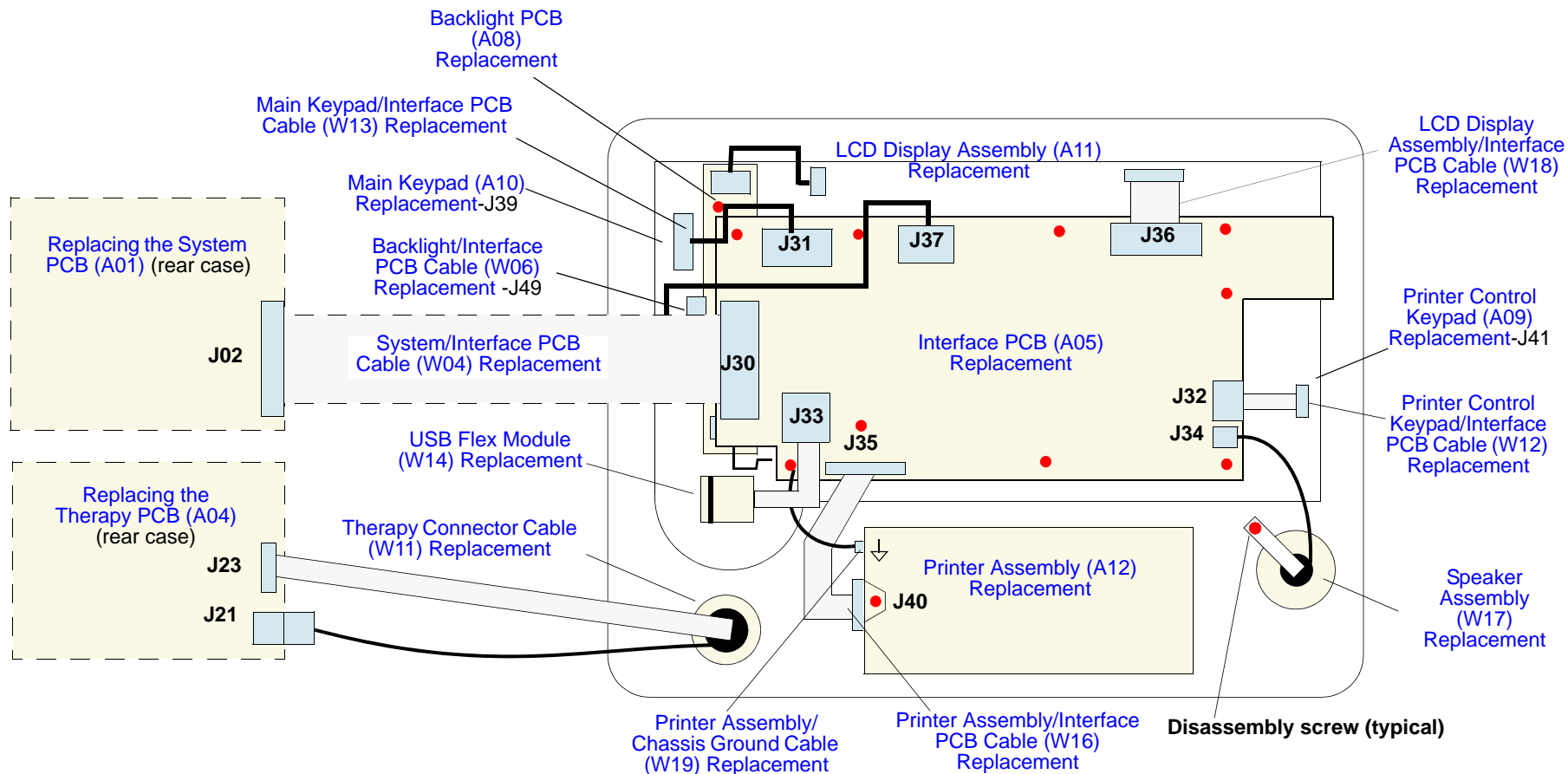

### Interface PCB (A05) Replacement

#### Interface PCB Replacement Figures

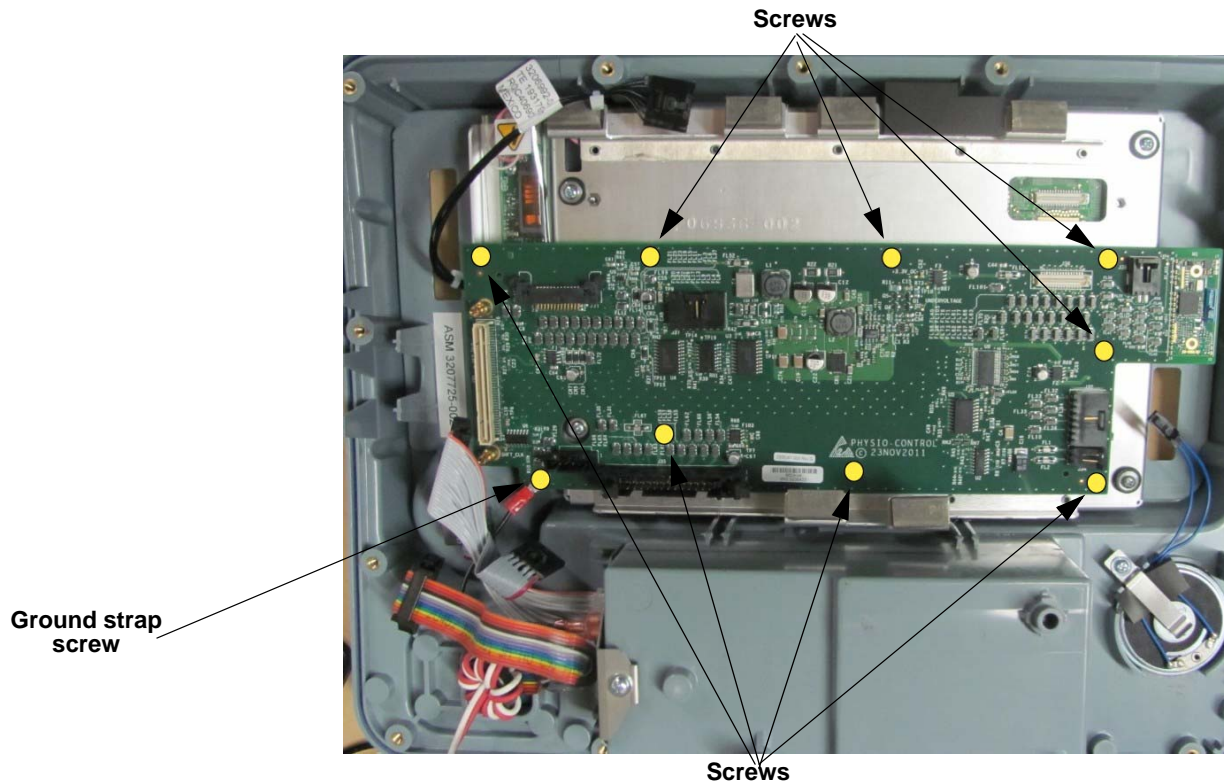

Figure 8.9—Interface PCB screw locations



Figure 8.10—Interface PCB cable connection locations - view 1 of 2

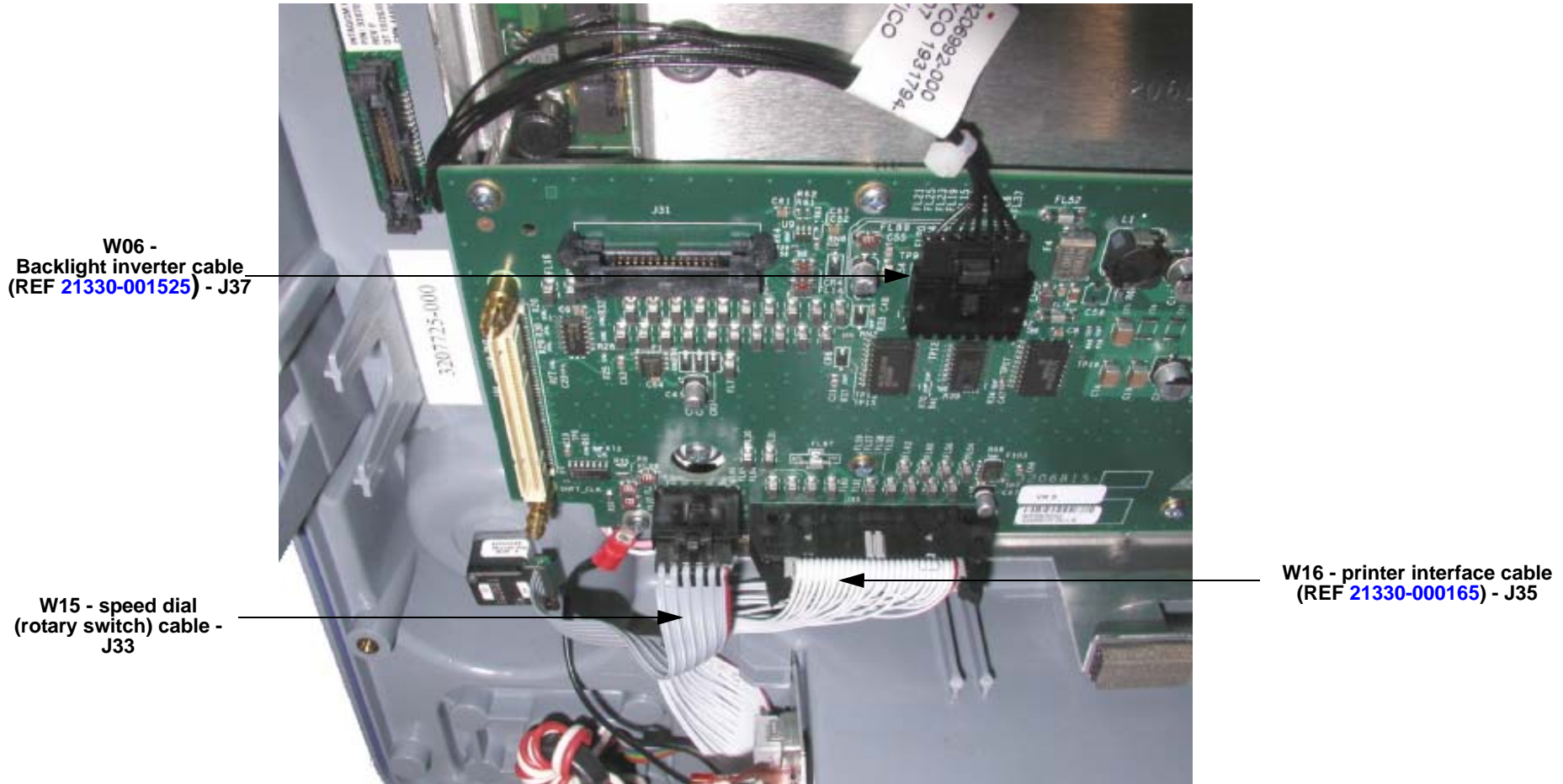

Figure 8.11—Interface PCB cable connection locations - view 2 of 2



### Removing the Interface PCB (A05)

Refer to [Interface PCB Replacement Figures \(p. 192\)](#) and [Inside Front Case Diagram \(p. 191\)](#).

- ◆ To remove the interface PCB (REF [21330-001533](#)) from the front case:
  1. Disassemble the case as described in [Disassembling the Case \(p. 183\)](#).
  2. Disconnect the connectors (from top left, counterclockwise) as follows (see [Figure 8.10 on p. 193](#) and [Figure 8.11 on p. 194](#)):
    - ~ J31 – Spread the connector locking tab and disconnect the main keypad interface PCB cable (W13).
    - ~ J37 – Press the connector locking tab and disconnect the backlight interface PCB cable (W06).
    - ~ J36 – Disconnect the LCD interface PCB cable (W18).
    - ~ J32 – Press the connector locking tab and disconnect the printer control keypad interface PCB cable (W12).
    - ~ J34 – Press the connector locking tab and disconnect the speaker interface PCB wire (W17).
    - ~ J35 – Spread the connector locking tabs and eject the printer interface cable (W16).
    - ~ J33 – Press the connector locking tab and disconnect the cable for the speed dial (W15).
  3. (If replacing the interface PCB) Disconnect the System/Interface cable as described in [System/Interface PCB Cable \(W04\) Replacement \(p. 215\)](#).
  4. Remove the screw holding the ground strap. Discard the screw.
  5. Remove the eight remaining screws (see [Figure 8.9 on p. 192](#)). Discard the screws.
  6. Remove interface PCB from the front case. Store in ESD safe container.

### Installing the Interface PCB (A05)

Refer to [Interface PCB Replacement Figures \(p. 192\)](#) and [Inside Front Case Diagram \(p. 191\)](#).

◆ To install the interface PCB into the front case:

**NOTE:** If a new interface PCB is required, install the [Interface PCBA Repair Kit, \(REF 40577-000042\)](#).

1. Attach the interface PCB to the bracket with the eight new screws (REF 21300-001038); torque to 6.8 in-lb (see [Figure 8.9 on p. 192](#)).
2. Install the ground strap (W19) with one new screw (REF 21300-001038); torque to 6.8 in-lb (see [Figure 8.9 on p. 192](#)).
3. Install the connectors clockwise, as follows (make sure all connector locking tabs are positioned to secure their respective connectors) (see [Figure 8.10 on p. 193](#) and [Figure 8.11 on p. 194](#)):
  - ~ J31 – Install the main keypad interface PCB cable (W13, REF 21330-001323).
  - ~ J37 – Install the backlight interface PCB cable (W06, REF 21330-001525).
  - ~ J36 – Install the LCD interface PCB cable (W18, REF 21330-001417).
  - ~ J32 – Install the printer control keypad interface PCB cable (W12, REF 21330-001214).
  - ~ J34 – Install the speaker interface PCB wire (W17, REF 21300-001371).
  - ~ J35 – Install the printer interface cable (W16, REF 21330-000165).
  - ~ J33 – Install the speed dial cable (W15, REF 21300-003713).
4. If the interface PCB was replaced, install the system/interface cable to the interface PCB as described in [System/Interface PCB Cable \(W04\) Replacement \(p. 215\)](#)
5. Reassemble the case as described in [Reassembling the Case \(p. 186\)](#).

### Backlight PCB (A08) Replacement

The backlight PCB replacement consists of:

- [Removing the Backlight PCB \(A08\) \(p. 198\)](#)
- [Installing the Backlight PCB \(A08\) \(p. 199\)](#)

Refer to [Inside Front Case Diagram \(p. 191\)](#).

### Removing the Backlight PCB (A08)

- ◆ To remove the backlight PCB from the front case:
  1. Disassemble the case as described in [Disassembling the Case \(p. 183\)](#).
  2. Remove the interface PCB as described in [Removing the Interface PCB \(A05\) \(p. 195\)](#).
  3. Disconnect the backlight/interface PCB cable (W06). Press the connector locking tab and disconnect the W06 cable from the interface PCB at J37. Then place even pressure on the cable and ease the W06 cable out of the connector on the Backlight PCB.
  4. Remove the two backlight inverter mounting screws. Discard the screws.
  5. Lift the backlight inverter off of the display assembly and disconnect the two end connectors from the LCD display assembly.
  6. Remove the inverter cover (REF [21300-007079](#)).

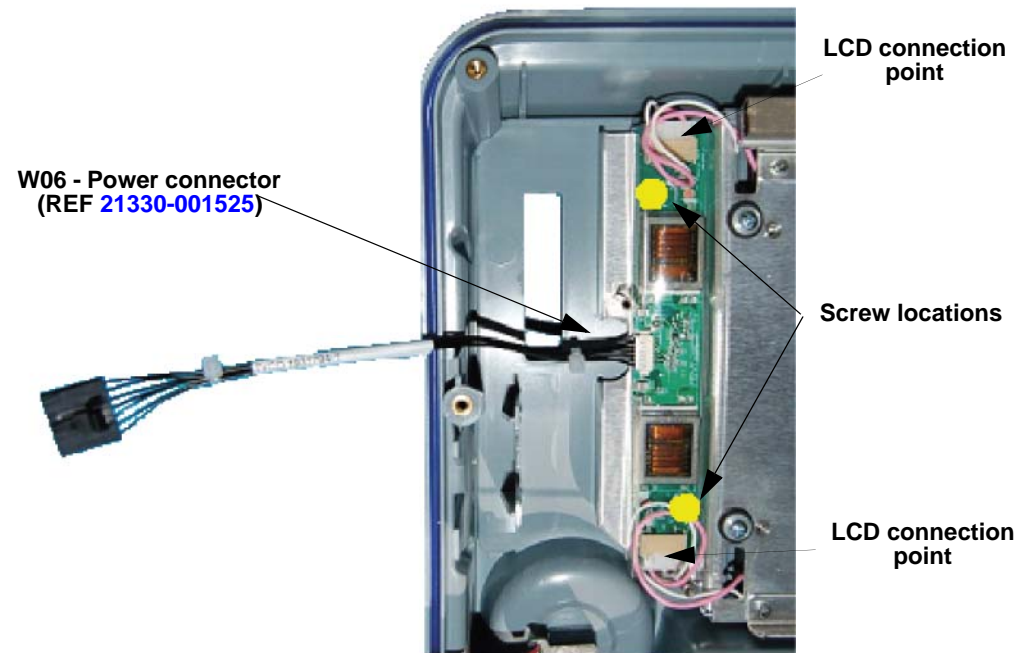

Figure 8.12—Screw location and cable connection for backlight PCB

### Installing the Backlight PCB (A08)

◆ To install the backlight PCB into the front case:

**NOTE:** If a new backlight PCB is required, install the [Display Driver Repair Kit \(REF 40577-000001\)](#) (p. 486) along with [Display Repair Kit \(REF 40577-00044\)](#) (p. 486).

1. Place the inverter cover (REF [21300-007079](#)) over the backlight PCB.
2. Connect the two end connectors to the LCD display assembly.
3. Connect the backlight/interface PCB cable (W06) (REF [21330-001525](#)) to backlight power connector.
4. Place the backlight inverter on the display assembly and install with two new screws (REF [21300-001038](#)); torque to 6.8 in-lb.
5. Feed excess length of LCD wires into backlight inverter cover.
6. Install the interface PCB as described in [Installing the Interface PCB \(A05\)](#) (p. 196).
7. Reassemble the case as described in [Reassembling the Case](#) (p. 186).

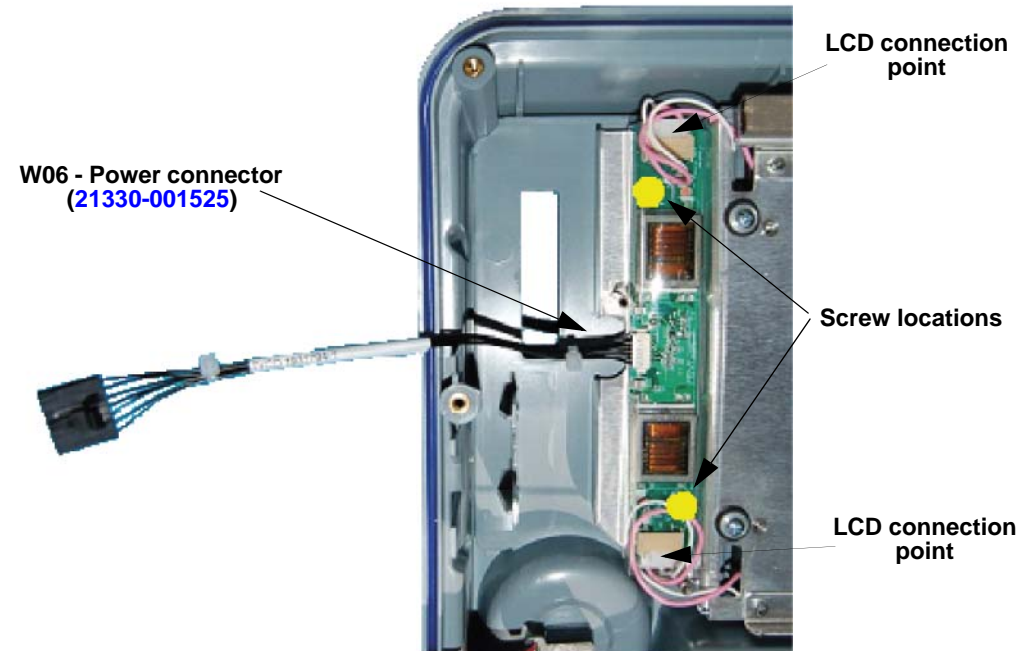

Figure 8.13—Screw location and cable connection for backlight PCB

### Printer Control Keypad (A09) Replacement

Printer control keypad replacement consists of the following:

- [Removing the Printer Control Keypad \(A09\) \(p. 201\)](#)
- [Installing the Printer Control Keypad \(A09\) \(p. 201\)](#)



Figure 8.14—Printer control keypad replacement

### Removing the Printer Control Keypad (A09)

Refer to [Figure 8.14 on p. 200](#).

- ◆ To remove the printer control keypad from outside the front case:
  1. Using a very thin, wide, flat-edged tool (example, 1.5" putty knife), gently pry one edge of the printer control keypad until it is released from its adhesive mount. **Take care not to damage the case.**
  2. Pull the printer control keypad away from the case, extending part of the W12 cable (see [Figure 9.50 on p. 461](#)) through the keypad opening.
  3. Disconnect the W12 cable from printer control keypad at J41. Make sure the W12 cable does not fall back into the front case.

### Installing the Printer Control Keypad (A09)

Refer to [Figure 8.14 on p. 200](#).

**NOTE:** Before installing the new printer control keypad, verify that the shelf-life date printed on the printer control keypad package has not expired.

- ◆ To install the new printer control keypad (see [Table 9.11 on page 402](#) for keypad catalog numbers):
  1. Using a soft, lint-free cloth and isopropyl alcohol, gently remove old adhesive from the printer control keypad cavity on the front case.
  2. Connect the W12 cable (REF [21330-001214](#)) to the printer control keypad at J41.
  3. Check that connector locking tab is securely latched.
  4. Remove the protective covering from the keypad adhesive surface and press the keypad firmly and evenly into the keypad cavity on the front case.

### Main Keypad (A10) Replacement

Main keypad replacement consists of the following:

- [Removing the Main Keypad \(A10\) \(p. 203\)](#)
- [Installing the Main Keypad \(A10\) \(p. 203\)](#)



Figure 8.15—Main keypad



### Removing the Main Keypad (A10)

Refer to [Figure 8.15 on p. 202](#).

- ◆ To remove the main keypad from outside the front case:
  1. Using a very thin, wide, flat-edged tool (example, 1.5" putty knife), gently pry one edge of the main keypad until it is released from its adhesive mount. **Take care not to damage the case.**
  2. Pull the main keypad away from the case, extending part of the W13 cable through the keypad opening.
  3. Spread the locking tabs and disconnect the W13 cable (see [Figure 9.51 on p. 462](#)) from main keypad at J39. Make sure the W13 cable does not fall back into the front case.

### Installing the Main Keypad (A10)

Refer to [Figure 8.15 on p. 202](#).

**NOTE:** Before installing the new main keypad, verify that the shelf-life date printed on the main keypad package has not expired.

- ◆ To install the new main keypad (see [Table 9.12 on page 405](#) for keypad catalog numbers):
  1. Using a soft, lint-free cloth and isopropyl alcohol, gently remove old adhesive from the main keypad cavity on the front case.
  2. Connect the W13 cable (REF [21330-001323](#)) to the main keypad at J39.
  3. Check that connector locking tab is securely latched.
  4. Remove the protective covering from the keypad adhesive surface, and press the keypad firmly and evenly into the keypad cavity on the front case.

### Display Shield Replacement

Refer to [Inside Front Case Diagram \(p. 191\)](#) and [Figure 9.6 \(p. 365\)](#).

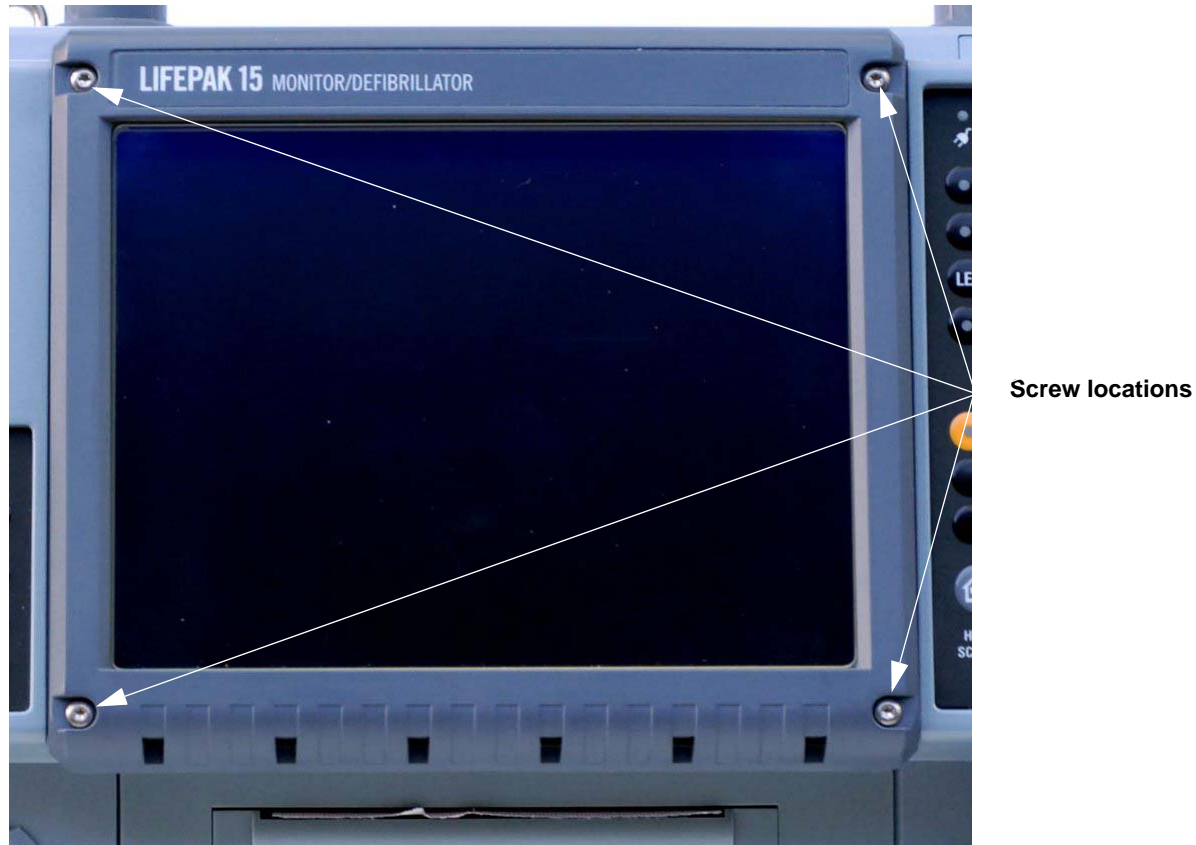

Figure 8.16—Display shield screw locations

### Removing the Display Lens Shield

Refer to [Figure 8.16 on p. 204](#).

- ◆ To remove the display shield from outside the front case:
  1. Remove the four screws from the display shield.
  2. Lift the display shield off of the front case assembly.

### Installing the Display Lens Shield

Refer to [Figure 8.16 on p. 204](#).

- ◆ To install the display shield onto the front case:
  - NOTE:** If new display shield is required, install the [Display Shield Repair Kit \(REF 40577-000006\) \(p. 489\)](#).
  - 1. Make sure the display lens surface and shield are completely clean and dust free before installing.
  - 2. Install the shield with four screws ([REF 21300-007196 \(p. 371\)](#)); torque to 6.8 in-lb using a T10 bit.
  - 3. If installing a new display lens shield, a new Label Set (Example, [REF 21501-002408](#)) (see [Table 9.13 on page 408](#)) is required. Clean display shield frame with isopropyl alcohol and install label number 10.

### LCD Display Assembly (A11) Replacement

The LCD display assembly replacement includes:

- [Removing the LCD Display Assembly \(A11\)](#) (p. 207)
- [Installing the LCD Display Assembly \(A11\)](#) (p. 207)

Refer to [Inside Front Case Diagram](#) (p. 191).

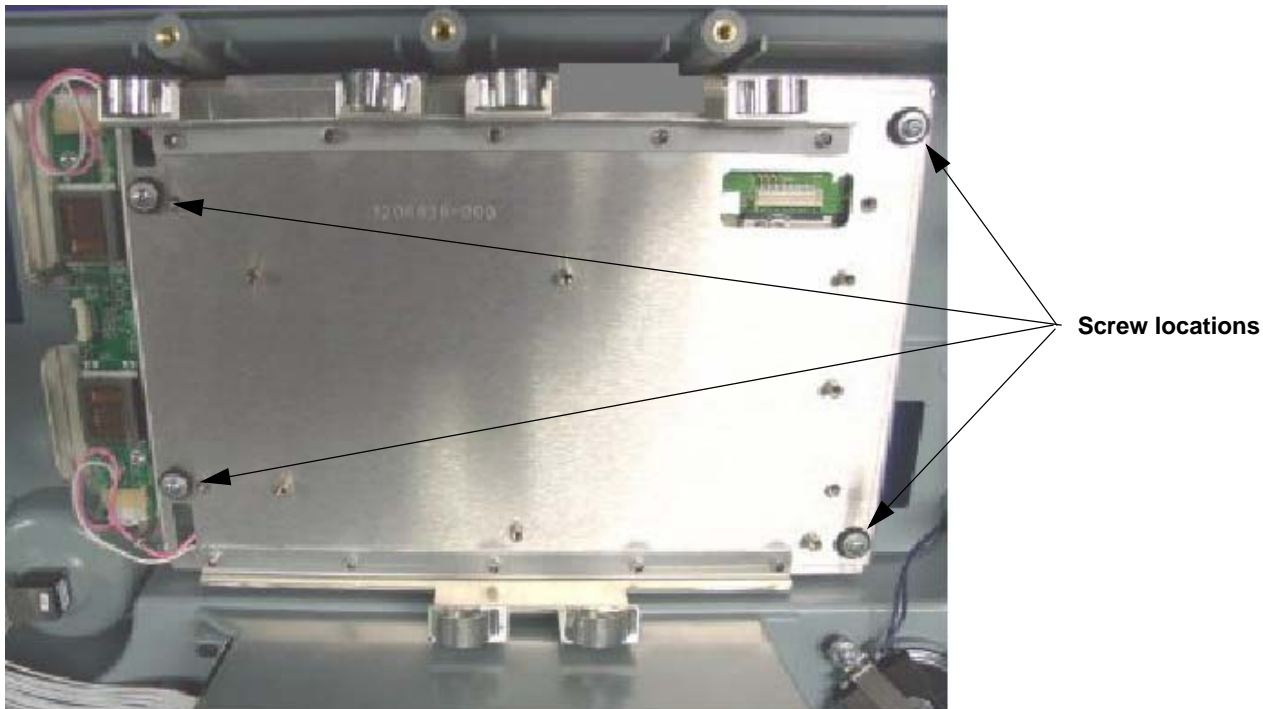

Figure 8.17—LCD display assembly screw locations

### Removing the LCD Display Assembly (A11)

- ◆ To remove the LCD display assembly from the front case ([Inside Front Case Diagram \(p. 191\)](#)):
  1. Disassemble the case as described in [Disassembling the Case \(p. 183\)](#).
  2. Remove the interface PCB as described in [Removing the Interface PCB \(A05\) \(p. 195\)](#).
  3. Remove the backlight inverter as described in [Removing the Backlight PCB \(A08\) \(p. 198\)](#).
  4. Remove the display/interface cable as described in [Removing the LCD Display Assembly/Interface PCB Cable \(W18\) \(p. 229\)](#).
  5. Remove the four LCD bracket mounting screws. Discard the screws.
  6. Remove the LCD mounting bracket from front case and place on workspace with LCD display assembly facing up.
  7. Remove four screws from the LCD display assembly. Discard the screws.
  8. Remove the LCD display from the LCD bracket.

### Installing the LCD Display Assembly (A11)

- ◆ To install the LCD display assembly into the front case:

**NOTE:** If a new LCD display assembly is required, use [Display Repair Kit \(REF 40577-00044\) \(p. 486\)](#) along with [Display Driver Repair Kit \(REF 40577-000001\) \(p. 486\)](#).

1. Make sure both the LCD display assembly screen and the front case lens are completely clean and dust free before reinstalling.
2. Place the LCD mounting bracket on workspace with display side facing up. Route LCD wires through Bracket openings.
3. Install the LCD display assembly onto the display mounting bracket with four new screws ([REF 21300-001038](#)); torque to 6.8 in-lbs.
4. (If installing a new LCD display) Remove protective layer from LCD screen.
5. Place the LCD mounting bracket in the front case and secure with four new screws ([REF 21300-004599](#)); torque to 6.8 in-lb.
6. Install the display/interface cable as described in [Installing the LCD Display Assembly/Interface PCB Cable \(W18\) \(p. 229\)](#)
7. Install the backlight inverter as described in [Installing the Backlight PCB \(A08\) \(p. 199\)](#).

8. Install the interface PCB as described in [Installing the Interface PCB \(A05\) \(p. 196\)](#).
9. Reassemble the case as described in [Reassembling the Case \(p. 186\)](#).

### Display Lens Replacement

Refer to [Inside Front Case Diagram](#) (p. 191) and [Figure 9.6](#) (p. 365).

#### Removing the Display Lens

- ◆ To remove the display lens from outside the front case:

**NOTE:** Removing the front lens requires high direct pressure to remove. Suggest instead replacing front case; use [Front Case Repair Kit \(REF 40577-000010\)](#) (p. 492).

1. Disassemble the case as described in [Disassembling the Case](#) (p. 183)).
2. Remove the display shield as described in [Removing the Display Lens Shield](#) (p. 205).
3. Remove the interface PCB as described in [Removing the Interface PCB \(A05\)](#) (p. 195).
4. Remove the LCD assembly as described in [Removing the LCD Display Assembly \(A11\)](#) (p. 207).
5. From the inside of front case, push out the display lens.



Figure 8.18—Display lens location

### Installing the Display Lens

Refer to [Figure 8.18 on p. 209](#).

◆ To install the display lens onto the front case:

1. Using a soft, lint-free cloth and isopropyl alcohol, gently remove old adhesive from lens frame on the front case.
2. Remove adhesive liner from display lens and install on front case. Press down firmly all around edge of display lens.
3. Make sure the display lens surface is completely clean and dust free before installing LCD assembly.
4. Install the LCD assembly as described in [Installing the LCD Display Assembly \(A11\) \(p. 207\)](#).
5. Install the interface PCB as described in [Installing the Interface PCB \(A05\) \(p. 196\)](#).
6. Reassemble the case as described in [Reassembling the Case \(p. 186\)](#).



### Front Case Replacement

Refer to [Inside Front Case Diagram \(p. 191\)](#)



Figure 8.19—Front case replacement

### Disassembling the Front Case

Refer to [Figure 8.19 on p. 211](#).

◆ To disassemble the front case:

1. Remove the printer assembly as described in [Removing the Printer Assembly \(A12\) \(p. 346\)](#).
2. Separate the front and rear case halves as described in [Disassembling the Case \(p. 183\)](#).
3. Perform steps 1 through 3 to disconnect cables as described in [Removing the Interface PCB \(A05\) \(p. 195\)](#). Note that J36 and J37 do not require removal.
4. Remove the four LCD bracket mounting screws (see [Figure 8.17 on p. 206](#)). Discard the screws.
5. Remove the printer control keypad cable from the back of the keypad as described in [Removing the Printer Control Keypad/Interface PCB Cable \(W12\) \(p. 219\)](#).
6. Remove the main keypad cable from the back of the keypad as described in [Removing the Main Keypad/Interface PCB Cable \(W13\) \(p. 220\)](#).
7. Remove the speed dial assembly as described in [Removing the Speed Dial Assembly \(W15\) \(p. 221\)](#).
8. Remove the speaker assembly as described in [Removing the Speaker Assembly \(W17\) \(p. 227\)](#).
9. Remove the therapy connector cable as described in [Removing the Therapy Connector Cable \(W11\) \(p. 217\)](#).
10. Remove the printer assembly/interface PCB Cable (includes removal of the W19 cable) as described in [Removing the Printer Assembly/Interface PCB Cable \(W16\) \(p. 224\)](#).

### Assembling the Front Case

Refer to [Figure 8.19 on p. 211](#).

◆ To install the new front case: *15 steps, (Page 1 of 2)*

**NOTE:** Use the [Front Case Repair Kit \(REF 40577-000010\)](#) (p. 492).

**NOTE:** Transfer the following parts from the old front case to the new front case:

- ~ LCD/interface PCB assembly
- ~ W15 speed dial assembly
- ~ W17 speaker assembly
- ~ W11 therapy connector
- ~ W16 printer/interface PCB cable
- ~ W12 printer control keypad cable
- ~ W13 main keypad cable
- ~ Printer bracket (REF [21300-006100](#)) with W19 cable

1. Install the perimeter seal (REF [21300-002394](#)) into the groove on the front case.

**NOTE:** Thread the perimeter seal approximately 1.5 inches through the seal lock. Do not stretch the seal, as this will result in crimped corners.

2. Install the speed dial assembly as described in [Installing the Speed Dial Assembly \(W15\)](#) (p. 223).
3. Install the therapy connector cable as described in [Installing the Therapy Connector Cable \(W11\)](#) (p. 217).
4. Install the printer assembly/interface PCB Cable (includes the W19 cable) as described in [Installing the Printer Assembly/Interface PCB Cable \(W16\)](#) (p. 225).
5. Install the speaker assembly as described in [Installing the Speaker Assembly \(W17\)](#) (p. 228).

- ◆ To install the new front case: *(Continued) 15 steps, (Page 2 of 2)*
  6. Install the display lens as described in [Installing the Display Lens \(p. 210\)](#).
  7. Install the display shield as described in [Installing the Display Lens Shield \(p. 205\)](#).
  8. Install the LCD/Interface PCB assembly by installing the LCD mounting bracket in the front case and secure with four new screws (REF [21300-004599](#)); torque to 6.8 in-lb.
  9. Reconnect cables to interface PCB by performing step 3 as described in [Installing the Interface PCB \(A05\) \(p. 196\)](#).
  10. Install the printer control keypad as described in [Installing the Printer Control Keypad \(A09\) \(p. 201\)](#).
  11. Install the main keypad as described in [Installing the Main Keypad \(A10\) \(p. 203\)](#).
  12. Reassemble the case as described in [Reassembling the Case \(p. 186\)](#).
  13. Clean the front case with isopropyl alcohol, and apply Physio-Control logo (REF [21501-002038](#)) to the location provided in upper left of front case.
  14. Install the printer assembly as described in [Installing the Printer Assembly \(A12\) \(p. 347\)](#).
  15. Installing the label set (Example, REF [21501-002408](#), see [Table 9.13 on page 408](#)) is required. Clean the front case areas with isopropyl alcohol and install label numbers 4, 6, 10 and 11.

### System/Interface PCB Cable (W04) Replacement

Refer to [Inside Front Case Diagram \(p. 191\)](#).

#### Removing the System/Interface PCB Cable (W04)

- ◆ To remove the system/interface PCB W04 cable (REF [21330-001226](#)) (see [Figure 8.10 on p. 193](#) and [Figure 9.41 on p. 452](#)) from the front case:

**NOTE:** Cable solder connections are fragile; keep handling to a minimum.

1. Disassemble the case as described in [Disassembling the Case \(p. 183\)](#). This procedure removes the W04 cable from the system PCB (A01) at J2.
2. Disconnect the W04 cable from the interface PCB at J30.

#### Installing the System/Interface PCB Cable (W04)

- ◆ To install the system/interface PCB W04 cable (REF [21330-001226](#)) (see [Figure 9.41 on p. 452](#)) into the front case:

  1. Snap connector of the System/Interface cable (W04) (REF [21330-001226](#)) over tabs and connect to interface PCB at J30. Check that connector is fully seated.
  2. Reassemble the case as described in [Reassembling the Case \(p. 186\)](#) to connect the W04 cable to the system PCB (A01) at J2.

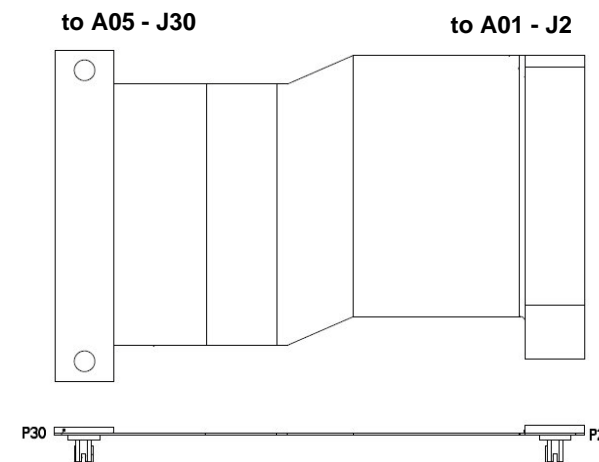

**Figure 8.20—System/interface PCB cable connections**

### Backlight/Interface PCB Cable (W06) Replacement

Refer to [Inside Front Case Diagram \(p. 191\)](#).

#### Removing the Backlight/interface PCB (W06) Cable

- ◆ To remove the backlight/interface W06 cable (REF [21330-001525](#)) (see [Figure 9.43 on p. 454](#)) from the front case:
  1. Disassemble the case as described in [Disassembling the Case \(p. 183\)](#).
  2. Press the connector locking tab and disconnect the W06 cable from the interface PCB at J37.
  3. Place even pressure on the cable and ease the W06 cable out of the connector on the Backlight PCB.

#### Installing the Backlight/interface PCB (W06) Cable

- ◆ To install the backlight/interface W06 cable into the front case:
  1. Connect the W06 cable (REF [21330-001525](#)) to the Backlight PCB.
  2. Connect the W06 cable to the interface PCB at J37.
  3. Reassemble the case as described in [Reassembling the Case \(p. 186\)](#).

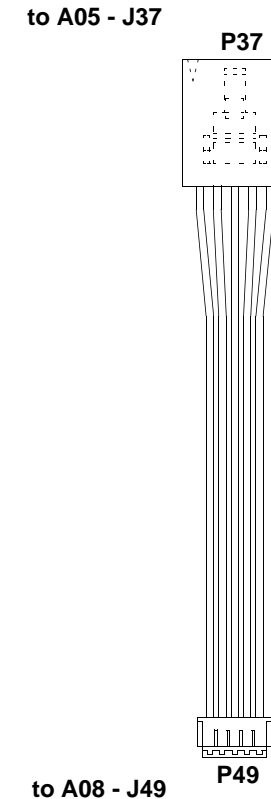

Figure 8.21—Backlight PCB/interface PCB cable connections

### Therapy Connector Cable (W11) Replacement

Refer to [Inside Front Case Diagram \(p. 191\)](#).

#### Removing the Therapy Connector Cable (W11)

- ◆ To remove the therapy connector cable (see [Figure 9.49 on p. 460](#)) from the front case:
  1. Disassemble the case as described in [Disassembling the Case \(p. 183\)](#).
  2. From the outside of the front case, remove the four screws from the therapy connector.
  3. Lift the therapy Connector cable and therapy mounting seal from the front case. Discard the four screws and therapy mounting seal.

#### Installing the Therapy Connector Cable (W11)

- ◆ To install the therapy Connector cable into the front case:

*4 steps, (Page 1 of 2)*

**NOTE:** If therapy connector cable requires replacement, use the [Therapy Connector Repair Kit \(REF 40577-000033\) \(p. 485\)](#).

1. From the outside of the front case, install a new therapy mounting seal (REF [21300-007464](#)) into the front case.

#### CAUTION

**POSSIBLE MOISTURE LEAKAGE** When installing the therapy connector, use a new therapy mounting seal to help prevent ingress of fluids.

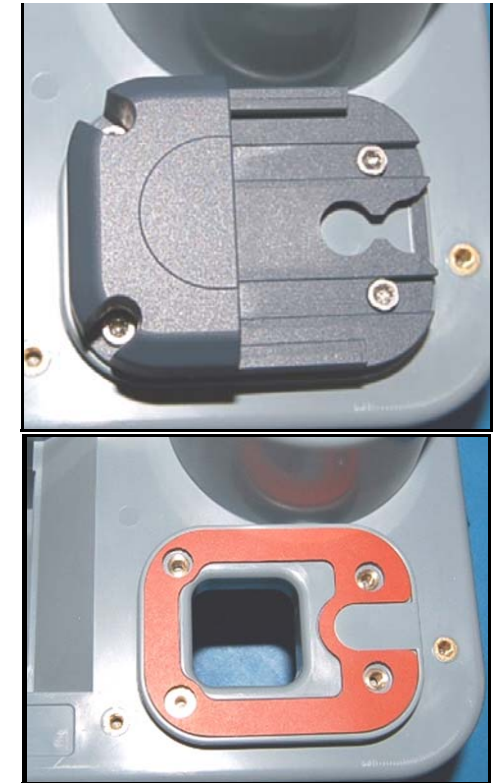

Figure 8.22—Therapy connector cable and seal

- ◆ To install the therapy Connector cable into the front case:

*(Continued) 4 steps, (Page 2 of 2)*

2. From the outside of the front case, insert the new therapy Connector cable through the therapy mounting seal and front case.
3. Secure the therapy connector to the front case with four new screws (REF [21300-007253](#)); torque to 10 in-lb using a T15 bit.
4. Reassemble the case as described in [Reassembling the Case \(p. 186\)](#).



### Printer Control Keypad/Interface PCB Cable (W12) Replacement

Refer to [Inside Front Case Diagram](#) (p. 191).

#### Removing the Printer Control Keypad/Interface PCB Cable (W12)

See diagram on [Figure 9.29](#) on p. 440.

- ◆ To remove the W12 cable (REF [21330-001214](#)) from the front case:
  1. Disassemble the case as described in [Disassembling the Case](#) (p. 183).
  2. Press the connector locking tab, and then disconnect the W12 cable from the interface PCB at J32.
  3. Press the connector locking tab, and then disconnect the W12 cable from the printer control keypad at J41.

#### Installing the Printer Control Keypad/Interface PCB Cable (W12)

- ◆ To install the W12 cable into the front case:
  1. Connect the W12 cable (REF [21330-001214](#)) to the printer control keypad at J41.
  2. Connect the W12 cable to the interface PCB at J32.
  3. Reassemble the case as described in [Reassembling the Case](#) (p. 186).

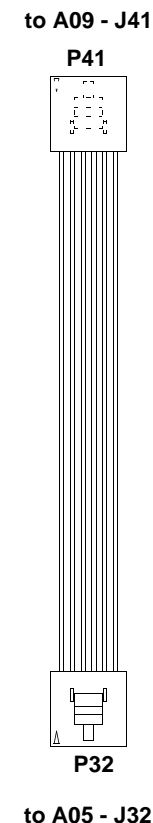

Figure 8.23—Printer control keypad/interface PCB cable connections

### Main Keypad/Interface PCB Cable (W13) Replacement

Refer to [Inside Front Case Diagram \(p. 191\)](#).

#### Removing the Main Keypad/Interface PCB Cable (W13)

- ◆ To remove the W13 cable (REF [21330-001323](#)) from the front case:
  1. Disassemble the case as described in [Disassembling the Case \(p. 183\)](#).
  2. Press the connector locking tabs to unlock the connector, and then disconnect the W13 cable from the interface PCB at J31.
  3. Press the connector locking tabs to unlock the connector, and then disconnect the W13 cable from the main keypad at J39.

#### Installing the Main Keypad/Interface PCB Cable (W13)

- ◆ To install the W13 cable (REF [21330-001323](#)) into the front case:
  1. Connect the W13 cable to the main keypad at J39 (“snap” the connector locking tabs into the locked position).
  2. Connect the W13 cable to the interface PCB at J31 (“snap” the connector locking tabs into the locked position).
  3. Reassemble the case as described in [Reassembling the Case \(p. 186\)](#).

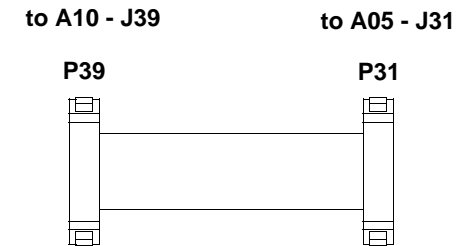

Figure 8.24—Main keypad/interface PCB cable connections

### Speed Dial Assembly (W15) Replacement:

#### Removing the Speed Dial Assembly (W15)

- ◆ To remove the speed dial assembly (REF [21300-003713](#)) (see [Figure 9.53 on p. 464](#)) from the front case: *5 steps, (Page 1 of 2)*
  1. Disassemble the case as described in [Disassembling the Case \(p. 183\)](#).
  2. Press the connector locking tab, and then disconnect the speed dial assembly cable from the interface PCB at J33.
  3. From the outside of the front case, grasp the speed dial assembly knob and, with steady smooth force, pull the knob off the speed dial assembly shaft. Use a gripping tool if necessary; take care to avoid any damage.

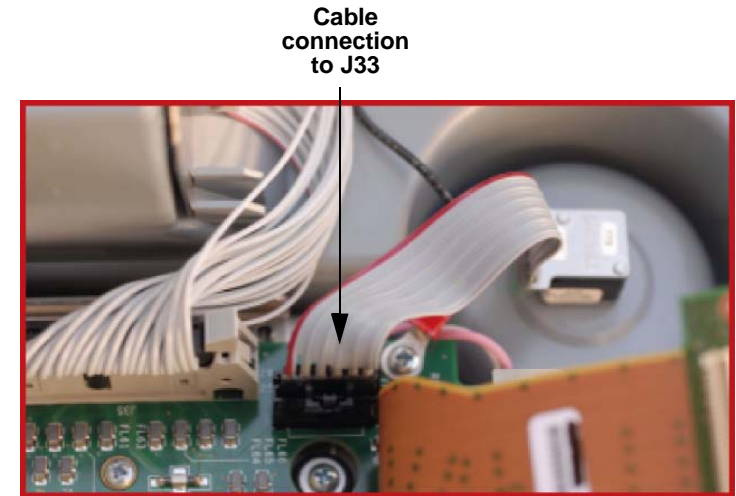

Figure 8.25—Speed dial cable

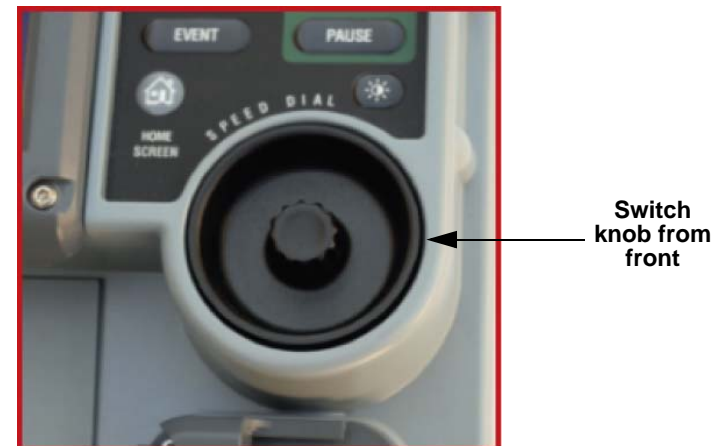

Figure 8.26—Speed dial knob

- ◆ To remove the speed dial assembly (REF 21300-003713) (see [Figure 9.53 on p. 464](#)) from the front case: *(Continued) 5 steps, (Page 2 of 2)*
  4. From the outside of the case, loosen and remove the nut and lock washer (part of the speed dial assembly) from the speed dial assembly shaft.
  5. From the inside of the case, pull the speed dial assembly away from the case and remove it.

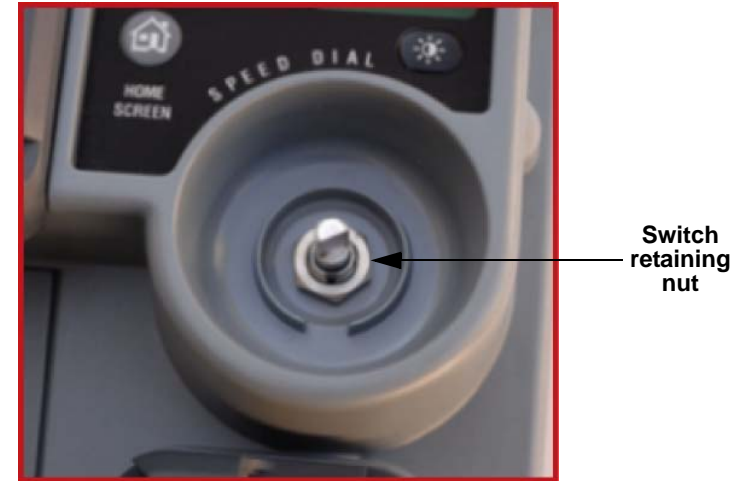

Figure 8.27—Nut and lock washer

### Installing the Speed Dial Assembly (W15)

- ◆ To install the speed dial assembly into the front case ([Inside Front Case Diagram \(p. 191\)](#)):

**NOTE:** When installing a new speed dial assembly (REF [21300-003713](#)) use [External Hardware Repair Kit \(REF 40577-000004\)](#) (p. 488).

1. Insert the speed dial assembly from inside the front case so that the cable is extending away from the perimeter seal.
2. Attach the speed dial assembly shaft to the front case with the nut and lock washer (torque to 10 in-lb using a 9/16 deep socket).
3. Push the knob (REF [21300-007051](#)) onto the speed dial assembly shaft from the outside of the front case (see [Figure 8.27 on p. 222](#)).
4. Connect the speed dial assembly to the interface PCB at J33.
5. Reassemble the case as described in [Reassembling the Case \(p. 186\)](#).

Rear of switch, orient  
with cable toward PCB

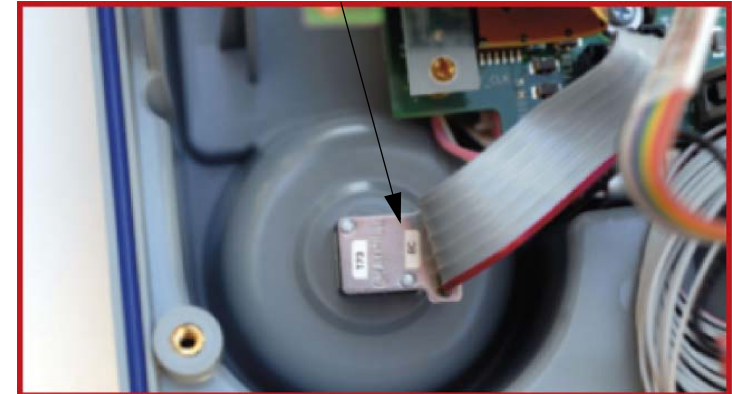

Figure 8.28—Speed dial assembly

Cable connection  
to J33

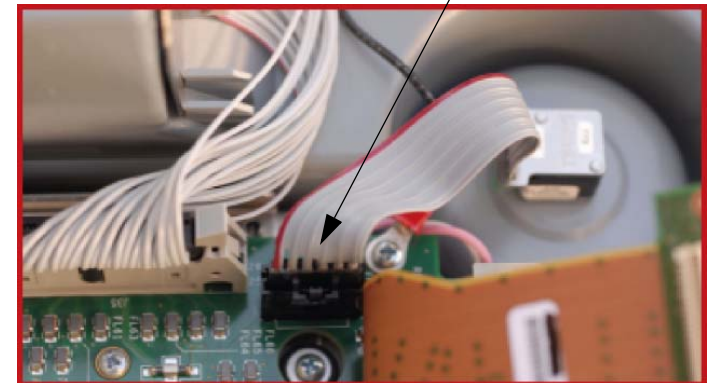

Figure 8.29—Speed dial cable

### Printer Assembly/Interface PCB Cable (W16) Replacement

Refer to [Inside Front Case Diagram \(p. 191\)](#).

#### Removing the Printer Assembly/Interface PCB Cable (W16)

- ◆ To remove the printer/interface PCB cable (REF [21330-000165](#)) (see [Figure 9.54 on p. 465](#)) from the front case:
  1. Disassemble the case as described in [Disassembling the Case \(p. 183\)](#).
  2. Spread the connector locking tabs and eject the W16 cable from the A05 interface PCB at J35.
  3. Disconnect the W19 cable ground terminal from the printer assembly connector bracket.
  4. Remove the retaining screw and connector bracket on the A12 printer assembly housing that secures the W16 cable at P40. Discard the screw.
  5. With a flat edged tool, gently pry the W16 cable at P40 out of the J40 connector on the printer assembly. Remove and discard the rubber moisture gasket.

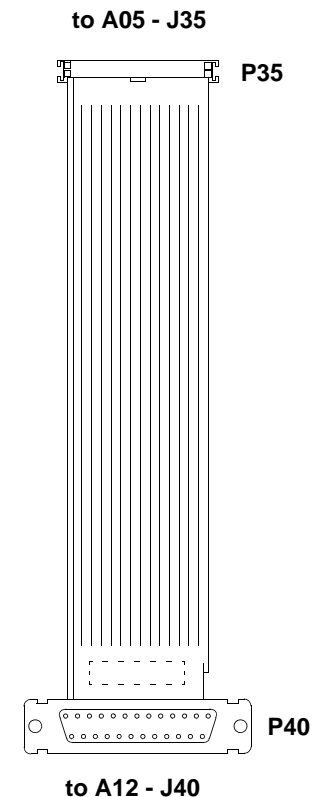

Figure 8.30—Printer / Interface PCB connection

### Installing the Printer Assembly/Interface PCB Cable (W16)

Refer to [Figure 8.30 on p. 224](#).

◆ To install the printer/interface PCB cable (W16) into the front case:

**NOTE:** When installing printer/interface PCB cable (REF [21330-000165](#)) use [External Hardware Repair Kit \(REF 40577-000004\)](#) (p. 488).

1. Install a new rubber moisture gasket (REF [21300-001299](#)) onto the W16 cable. Connect the W16 cable to the printer assembly at J40. Place the printer assembly connector bracket (REF [21300-006100](#)) over the printer W16 cable and secure it with one new screw with washer (REF [21300-007297](#)) into the front case; torque to 6.8 in-lb.
2. Connect the W19 cable ground terminal (REF [21300-001371](#)) to the printer assembly connector bracket.
3. Connect the W16 cable to the interface PCB at J35.
4. Reassemble the case as described in [Reassembling the Case \(p. 186\)](#).

### Speaker Assembly (W17) Replacement

Refer to [Inside Front Case Diagram](#) (p. 191).

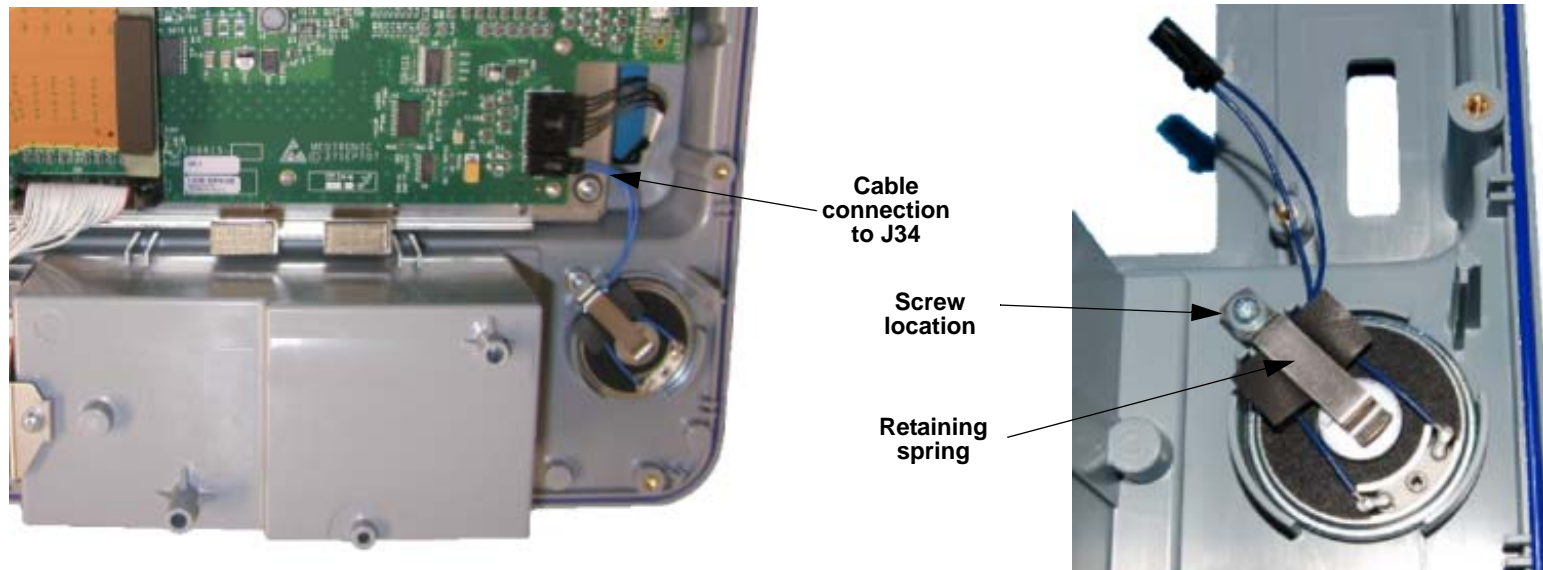

Figure 8.31—Speaker assembly replacement cable connection and screw location



### Removing the Speaker Assembly (W17)

Refer to [Figure 8.31 on p. 226](#).

- ◆ To remove the Speaker Assembly (REF 21300-001371) (see [Figure 9.55 on p. 466](#)) from the front case:
  1. Disassemble the case as described in [Disassembling the Case \(p. 183\)](#).
  2. Press the connector locking tab, and then disconnect the Speaker Assembly from the interface PCB at J34, if the interface PCB is present.
  3. Remove the screw securing the spring clamp for the W17 Speaker Assembly. Note the orientation of the spring clamp for reassembly. Discard the screw.
  4. Set the spring clamp aside, and then lift the Speaker Assembly from the front case.

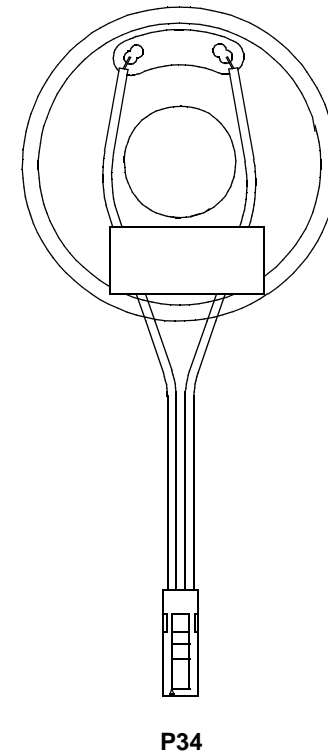

**Figure 8.32—Speaker Assembly connection**

### Installing the Speaker Assembly (W17)

Refer to [Figure 8.31 on p. 226](#).

◆ To install the Speaker Assembly into the front case ([Inside Front Case Diagram \(p. 191\)](#)):

**NOTE:** When installing speaker assembly (REF [21300-001371](#)) use [External Hardware Repair Kit \(REF 40577-000004\) \(p. 488\)](#).

1. Set the Speaker Assembly into the case and secure the spring clamp (REF [21300-001575](#)) with one new screw with washer (REF [21300-007297](#)); torque to 6.8 in-lb.

**NOTE:** Make sure you do not pinch the wires during reassembly.

#### CAUTION

**POSSIBLE MOISTURE LEAKAGE** When installing the Speaker Assembly, make sure the speaker felt moisture barrier is in place on the front case to help prevent ingress of fluids. When replacing the speaker, do not touch the speaker felt.

2. Connect the Speaker Assembly to the interface PCB at J34.
3. Reassemble the case as described in [Reassembling the Case \(p. 186\)](#).

### LCD Display Assembly/Interface PCB Cable (W18) Replacement

Refer to [Inside Front Case Diagram \(p. 191\)](#).

#### Removing the LCD Display Assembly/Interface PCB Cable (W18)

- ◆ To remove the LCD display/interface PCB W18 cable (REF [21330-001417](#)) from the front case:
  1. Disassemble the case as described in [Disassembling the Case \(p. 183\)](#).
  2. Remove the W18 cable (see [Figure 9.56 on p. 467](#)) from the interface PCB at J36.
  3. Place even pressure on the cable ribbon and ease the W18 cable out of the connector on the LCD display assembly.

#### Installing the LCD Display Assembly/Interface PCB Cable (W18)

- ◆ To install the LCD display/interface PCB W18 cable (REF [21330-001417](#)) into the front case:
  1. Connect the W18 cable to the connector on the LCD display assembly.
  2. Connect the W18 cable to the interface PCB at J36.
  3. Reassemble the case as described in [Reassembling the Case \(p. 186\)](#).

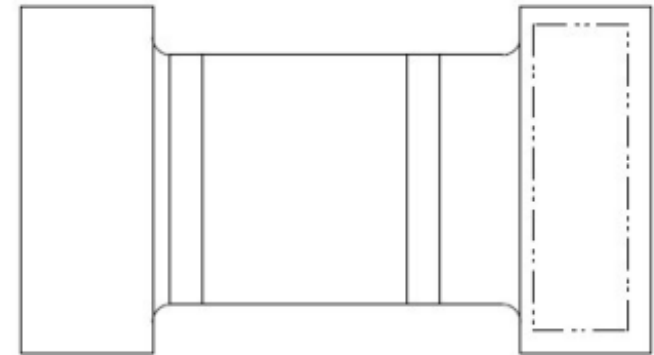

Figure 8.33—LCD cable connection

### Printer Assembly/Chassis Ground Cable (W19) Replacement

Refer to [Inside Front Case Diagram \(p. 191\)](#).

#### Removing the Printer Assembly/Chassis Ground Cable (W19)

- ◆ To remove the printer/chassis ground W19 cable (REF [21300-001370](#)) (see [Figure 9.57](#) on p. [468](#)) from the front case:
  1. Disassemble the case as described in [Disassembling the Case \(p. 183\)](#).
  2. Remove the screw securing the W19 cable to the interface PCB and LCD display assembly bracket. Discard the screw.
  3. Disconnect the W19 cable ground terminal from the printer assembly connector bracket.

#### Installing the Printer Assembly/Chassis Ground Cable (W19)

- ◆ To install the printer/chassis ground W19 cable (REF [21300-001370](#)) into the front case:
  1. Connect the W19 cable ground terminal to the printer assembly connector bracket.
  2. Secure the W19 cable to the interface PCB and LCD display assembly bracket ([21300-006100](#)) with one new screw (REF [21300-001038](#)); torque to 6.8 in-lb.
  3. Reassemble the case as described in [Reassembling the Case \(p. 186\)](#).

Chassis ground

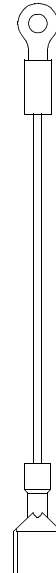

Printer Assembly (A12)

**Figure 8.34—Printer cable connection**

### Inside Rear Case Diagrams

The inside rear case diagrams include the following:

- [Rear Case Overview \(p. 232\)](#)
- [Rear Case Overview with System \(A01\)/Therapy \(A04\) PCBs Removed \(p. 233\)](#)

Numerous repair procedures refer to these diagrams.

### Rear Case Overview

Use this diagram after disassembling the case as described in [Disassembling the Case \(p. 183\)](#).

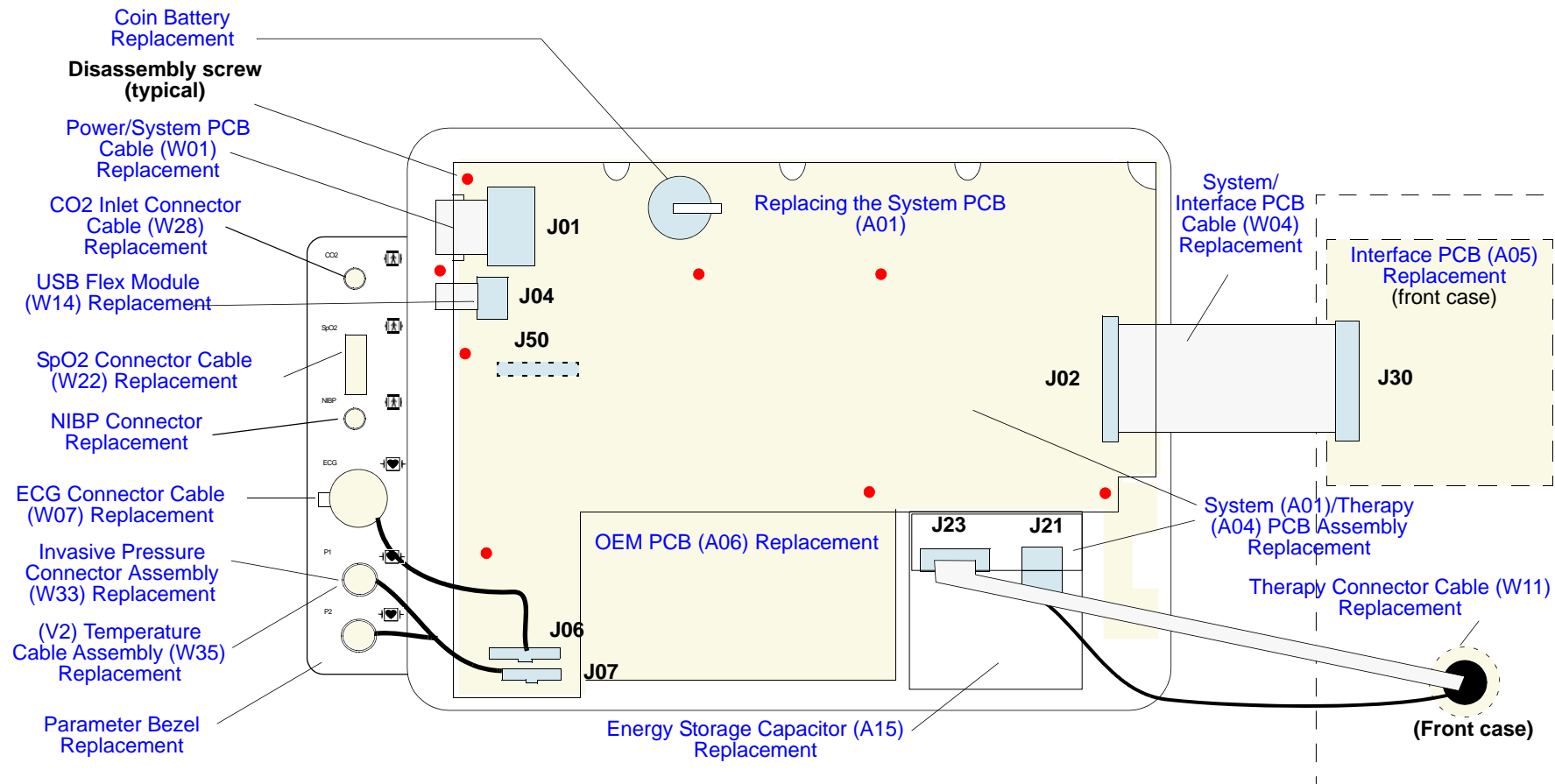

### Rear Case Overview with System (A01)/Therapy (A04) PCBs Removed

Diagram shows rear case view after removing the A01 system and A04 therapy PCBs as described in [System \(A01\)/Therapy \(A04\) PCB Assembly Replacement \(p. 234\)](#).

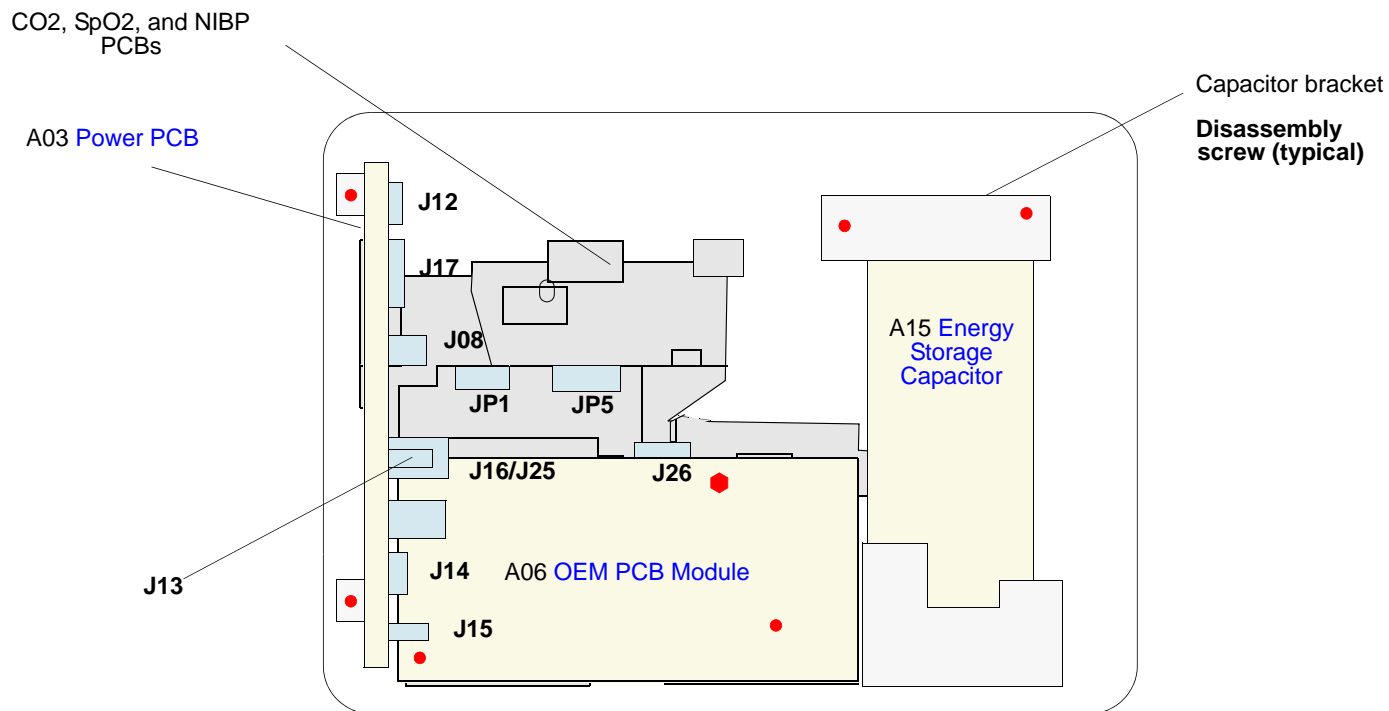

### System (A01)/Therapy (A04) PCB Assembly Replacement

The system/therapy PCB assembly is removed as a unit and then separated. Refer to [System/Therapy PCB Assembly Diagrams and Parts Lists \(p. 373\)](#) and [Figure 9.9 \(p. 374\)](#) for diagrams of this assembly. See [Figure 9.24 on p. 435](#) for a connection diagram of the therapy PCB and [Figure 9.22 on p. 433](#) for a connection diagram of the system PCB.

Replacement consists of the following procedures:

- [Removing the System \(A01\)/Therapy \(A04\) PCB Assembly \(p. 235\)](#)
- [Separating the System PCB \(A01\) \(p. 242\)](#)
- [Replacing the System PCB \(A01\) \(p. 244\)](#)
- [Separating the Therapy PCB \(A04\) \(p. 245\)](#)
- [Replacing the Therapy PCB \(A04\) \(p. 247\)](#)
- [Installing the System \(A01\)/Therapy \(A04\) PCB Assembly \(p. 238\)](#)



### Removing the System (A01)/Therapy (A04) PCB Assembly

- ◆ To remove the system/therapy PCBs as a single unit from the rear case: *9 steps, (Page 1 of 3)*
  1. Disassemble the case as described in [Disassembling the Case \(p. 183\)](#).
  2. Disconnect the connectors on the system PCB as follows:
    - ~ J6 – Disconnect the ECG connector cable (W7).
    - ~ (If present) J7 – Disconnect the IP connector of the IP wire harness (W33).
    - ~ (If present) J7 – Disconnect the temperature connector of the temperature cable (W35).

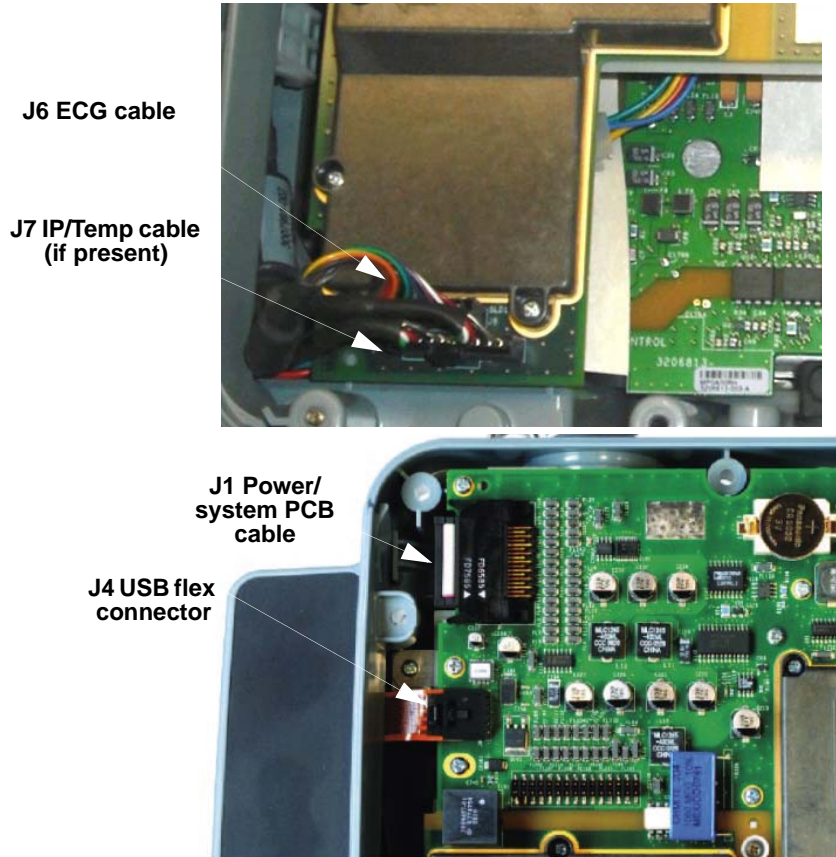

Figure 8.35—System PCB connectors

◆ To remove the system/therapy PCBs as a single unit from the rear case: *(Continued) 9 steps, (Page 2 of 3)*

3. Remove the seven screws and two screws with washer that secures the system PCB to the rear case. Discard the screws.

**NOTE:** The screw that is in the ECG shield can easily be missed as part of screw removal. Ensure that all screws are removed prior to lifting the system/therapy PCB assembly.

4. J1 – Press the connector locking tabs and disconnect the power/system PCB cable (W01).
5. J4 – Disconnect the USB flex connector (W14).

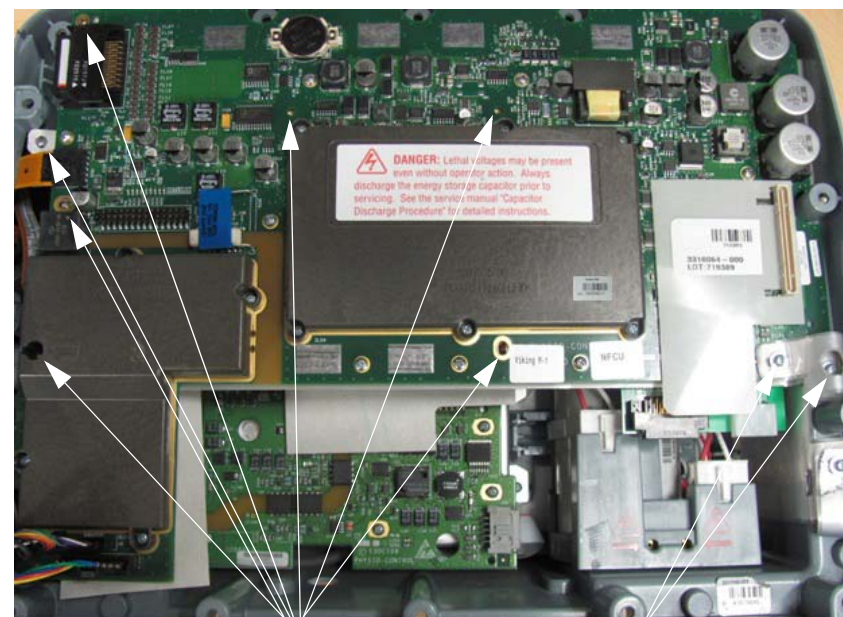

System/therapy mounting screws  
(7 places)

Mounting screw with washer  
(2 places)

Figure 8.36—System/therapy PCB screw locations

- ◆ To remove the system/therapy PCBs as a single unit from the rear case: *(Continued) 9 steps, (Page 3 of 3)*
  6. Carefully lift system/therapy PCB assembly to gain access to the cables below.
  7. Disconnect P22 of the therapy cap wire harness (W24) from J22 of cap discharge PCB assy.
  8. Disconnect the J20 connector on the therapy PCB (power/PCB therapy cable W02).
  9. Lift the system/therapy board assembly out from the rear case. Store Assembly in ESD safe container.

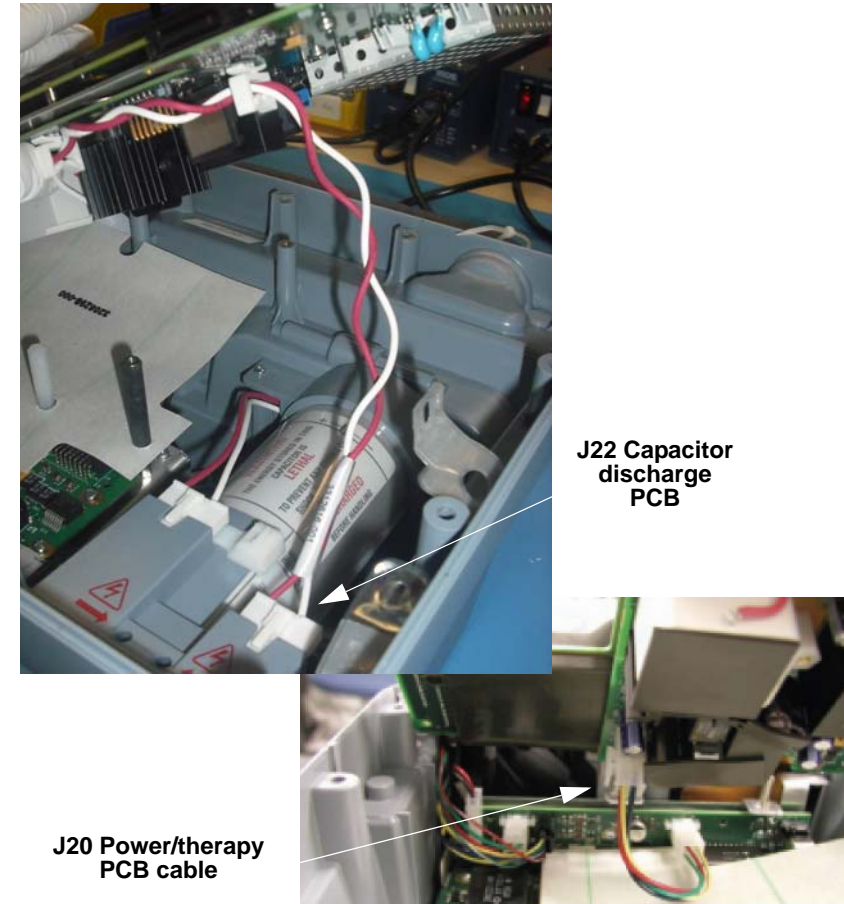

Figure 8.37—System/therapy PCB cable connections

### Installing the System (A01)/Therapy (A04) PCB Assembly

- ◆ To install the system/therapy PCB: *13 steps, (Page 1 of 4)*
  1. Line up the system/therapy assembly with rear case.
  2. Connect the power/system cable (W01) to J1 of system PCB.
  3. Connect the USB flex cable (REF [21330-001534](#)) (W14) to J4 of the system PCB.
  4. Connect the power/therapy cable (W02) from the power PCB P20 (REF [21300-001373](#)) to J20 of the therapy PCB.

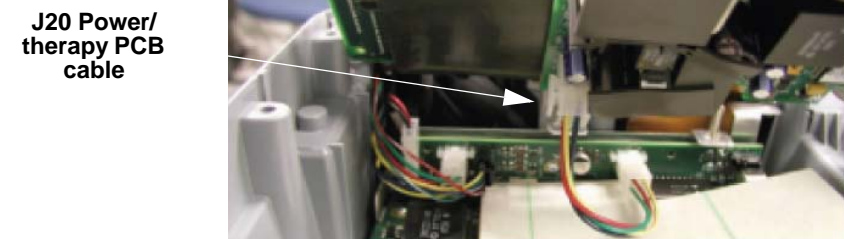
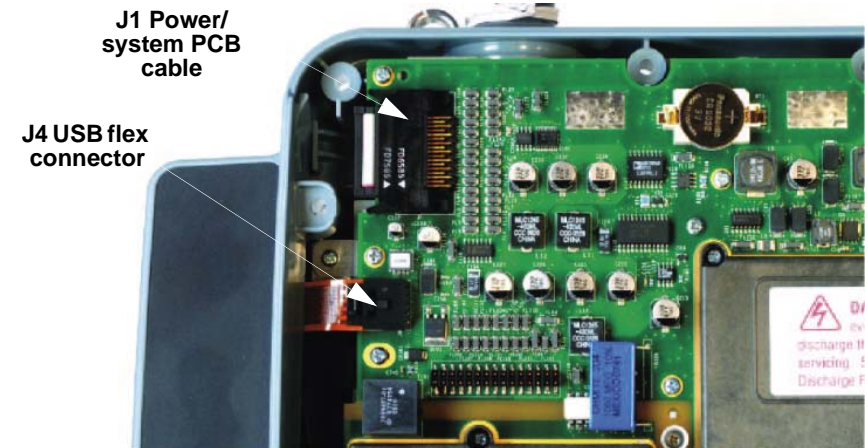
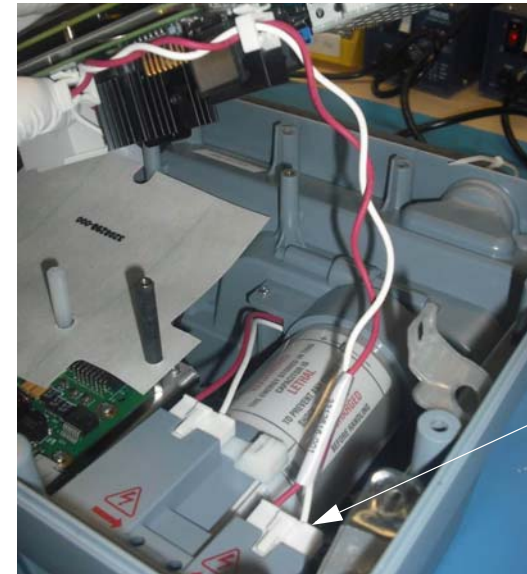
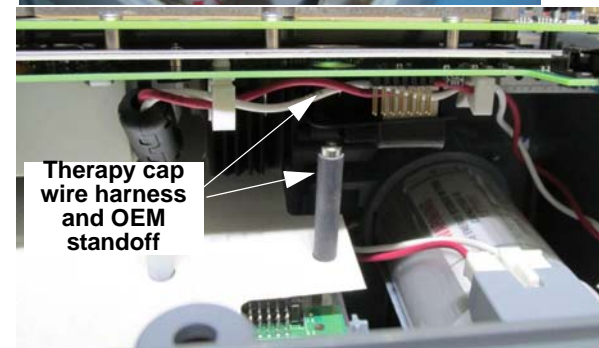

Figure 8.38—System/therapy PCB connections

- ◆ To install the system/therapy PCB: *(Continued) 13 steps, (Page 2 of 4)*
  5. Connect P22 of the therapy cap wire harness (W24) to J22 of cap discharge PCB assembly.
  6. Align System/Therapy PCB with inserts in Rear Case.
  7. Keep therapy cap wire harness clear of OEM standoff and screw hole.



J22 Capacitor discharge PCB assembly



Therapy cap wire harness and OEM standoff

Figure 8.39—System/therapy PCB cable connections

- ◆ To install the system/therapy PCB: *(Continued) 13 steps, (Page 3 of 4)*
  8. Line up the system PCB with the inserts in the rear case, and secure with seven new screws (REF [21300-001038](#); torque to 6.8 in-lb.
  9. Install one screw with washer (REF [21300-007297](#)) into mounting bracket. Capture the ground strap from the EMI Shield with one screw with washer (REF [21300-007297](#)); torque to 6.8 in-lb.

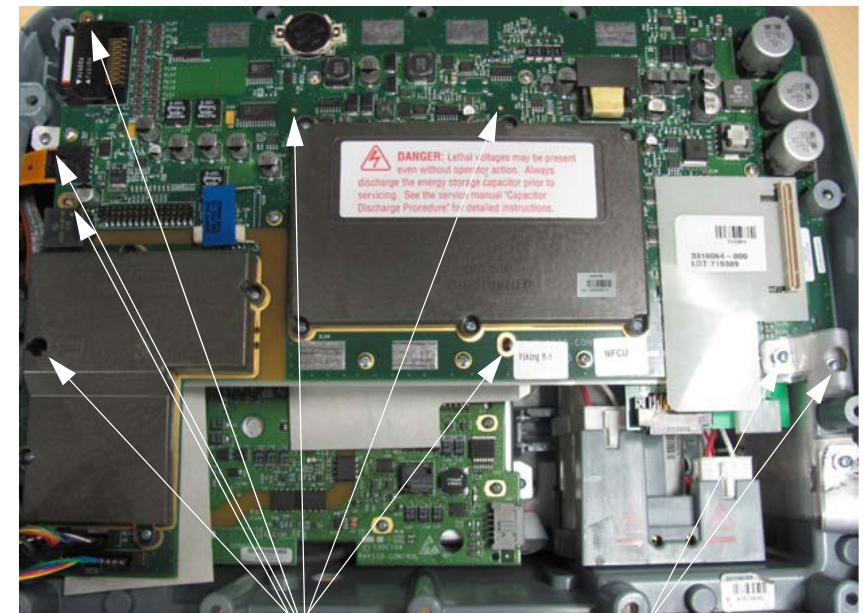

System/therapy mounting screws  
(7 places)

Mounting screw with washer  
(2 places)

Figure 8.40—System PCB screws

◆ To install the system/therapy PCB: *(Continued) 13 steps, (Page 4 of 4)*

10. Connect the W07 - ECG cable from the parameter bezel to J6 of the system PCB.
11. If present, connect the W33 - IP cable from the parameter bezel to J7 of the system PCB.
12. If present, connect the W35 - temperature cable from the parameter bezel to J7 of the system PCB.

**NOTE:** Route wires, ECG behind the connector and IP/Temp in front of connector to reduce possible cable pinch with the front case.

**NOTE:** The screw in the ECG shield can be mispositioned. Check to ensure that the screw is installed and torqued.

13. Reassemble the case as described in [Reassembling the Case \(p. 186\)](#).

J6 ECG cable  
J7 IP/Temp cable  
(if present)



Figure 8.41—ECG and IP/Temp connections

### Separating the System PCB (A01)

- ◆ To separate the system PCB (A01) from the therapy PCB (A04): *6 steps, (Page 1 of 2)*
  1. Disassemble the case as described in [Disassembling the Case \(p. 183\)](#).
  2. Remove the system/therapy PCBs as a unit as described in [Removing the System \(A01\)/Therapy \(A04\) PCB Assembly \(p. 235\)](#).



◆ To separate the system PCB (A01) from the therapy PCB (A04): *(Continued) 6 steps, (Page 2 of 2)*

3. Place the system/therapy PCB assembly with the system PCB face up on your work surface. Remove the ten screws. Discard the screws.

**NOTE:** One screw is beneath the System PCB shield. Lift shield gently to access.

4. Gently lift the system PCB up and away from the therapy PCB. The two PCBs are linked by the 30-pin header, which is a direct-connection contact assembly.
5. Remove 30 pin header from the system or therapy PCB.
6. Store system PCB in ESD safe container.

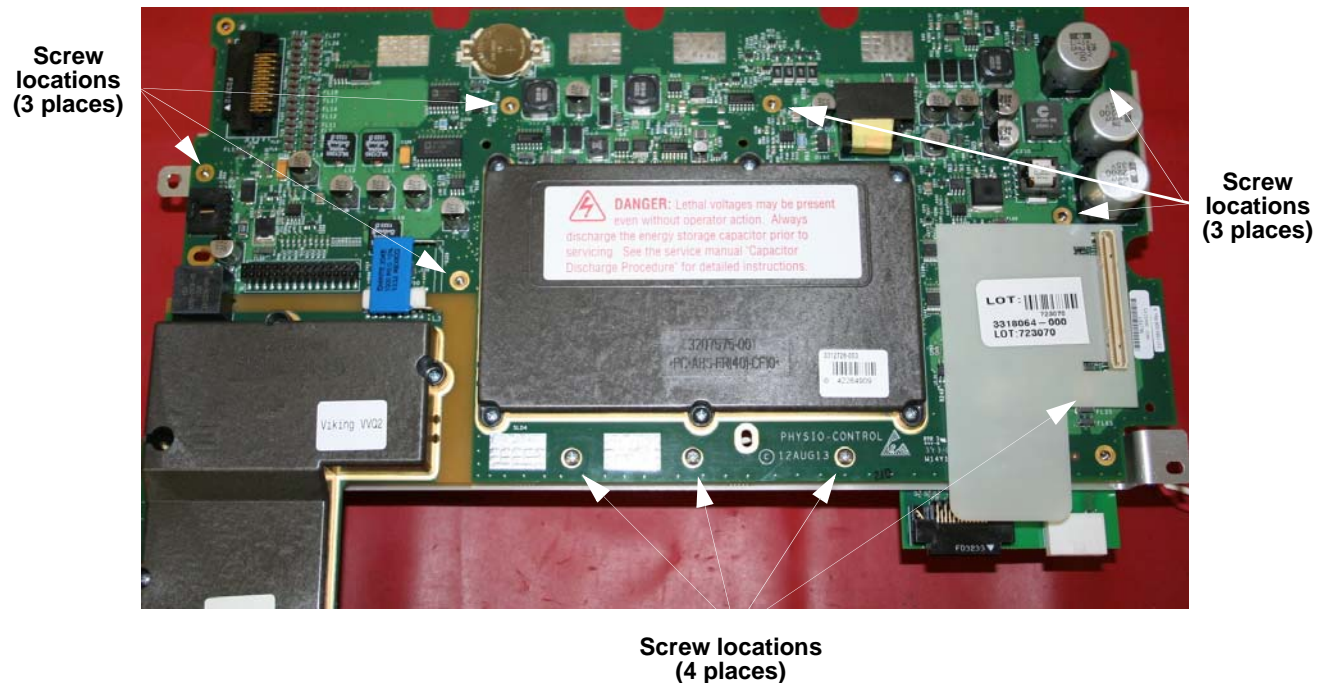

Figure 8.42—System/therapy PCB screw locations

### Replacing the System PCB (A01)

◆ To replace the system PCB (A01):

**NOTE:** When replacing the System PCB, use [System PCBA Repair Kit V4 \(REF 40577-000031\)](#) (p. 500).

1. Place therapy PCB facedown with the system/therapy mounting bracket already installed.
2. Verify that the 30 pin header has no bent pins, and insert the 30 pin header (REF [21300-001379](#)) into the J50 circuit side of the therapy PCB.
3. Align the system PCB (REF [21330-001539](#)) with the mounting bracket and 30 pin header into J5.
4. Fasten with ten new screws (REF [21300-001038](#)); torque to 6.8 in-lb (see [Figure 8.42 on p. 243](#)).
5. Follow the instructions to install the system/therapy assembly into device as described in [Installing the System \(A01\)/Therapy \(A04\) PCB Assembly \(p. 238\)](#).
6. After device reassembly, complete the TCP–Defibrillator Calibration procedure. The defibrillator calibration constants may be invalidated when you replace System PCB.

### Separating the Therapy PCB (A04)

◆ To remove the therapy PCB (A04): 7 steps, (Page 1 of 2)

1. Disassemble the case as described in [Disassembling the Case \(p. 183\)](#).
2. Remove the system/therapy assembly as described in [Removing the System \(A01\)/Therapy \(A04\) PCB Assembly \(p. 235\)](#).
3. Place the system/therapy PCB assembly with the therapy PCB face up. Remove the eight screws. Discard the screws.
4. Disconnect the W24 - therapy to cap discharge cable at J19 of therapy PCB. Remove cable from cable retainers.

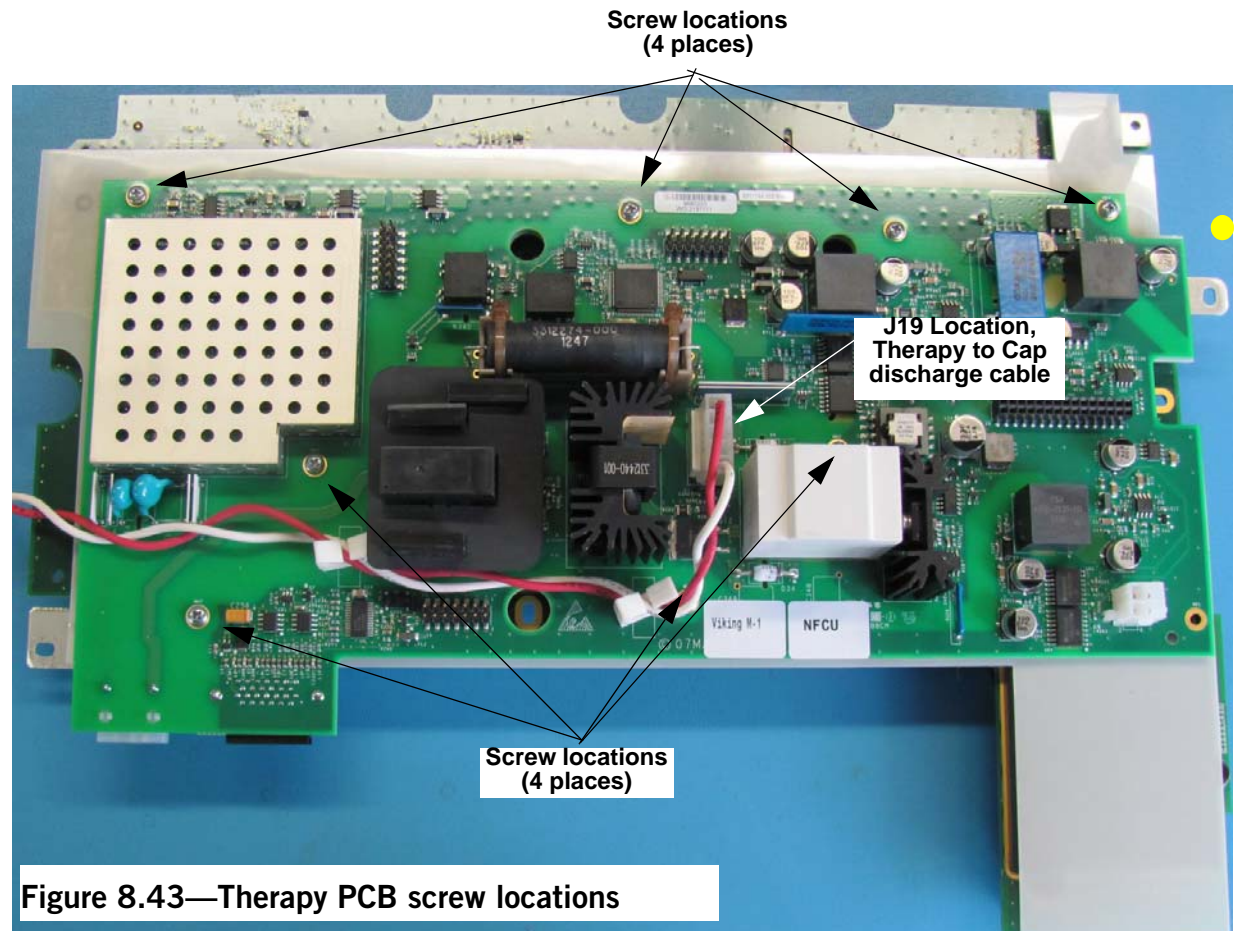

Figure 8.43—Therapy PCB screw locations



### Replacing the Therapy PCB (A04)

◆ To replace the therapy PCB (A04): *7 steps, (Page 1 of 3)*

**NOTE:** When replacing the therapy PCB, use [Therapy PCBA Repair Kit \(REF 40577-000032\)](#) (p. 484).

1. Place system PCB facedown on the work surface with the system/therapy mounting bracket installed.
2. Verify that the 30 pin header has no bent pins, and insert the 30 pin header (W03) (REF [21300-001379](#)) into the J50 circuit side of the therapy PCB.

◆ To replace the therapy PCB (A04): *(Continued) 7 steps, (Page 2 of 3)*

3. Align the therapy PCB (REF 21330-001538) with the system PCB. Insert the 30 pin header into J5 of system PCB and align with screw holes in mounting bracket. Ensure that the pins are protruding from hole in therapy PCB.
4. Attach therapy PCB with eight new screws (REF 21300-001038); torque to 6.8 in-lb.
5. Connect the therapy to cap discharge cable (REF 21330-001500) (W24) to J19 of therapy PCB. Route the cable through the retainer clips as shown.

**NOTE:** Route therapy to cap discharge cable away from round hole in therapy PCB.

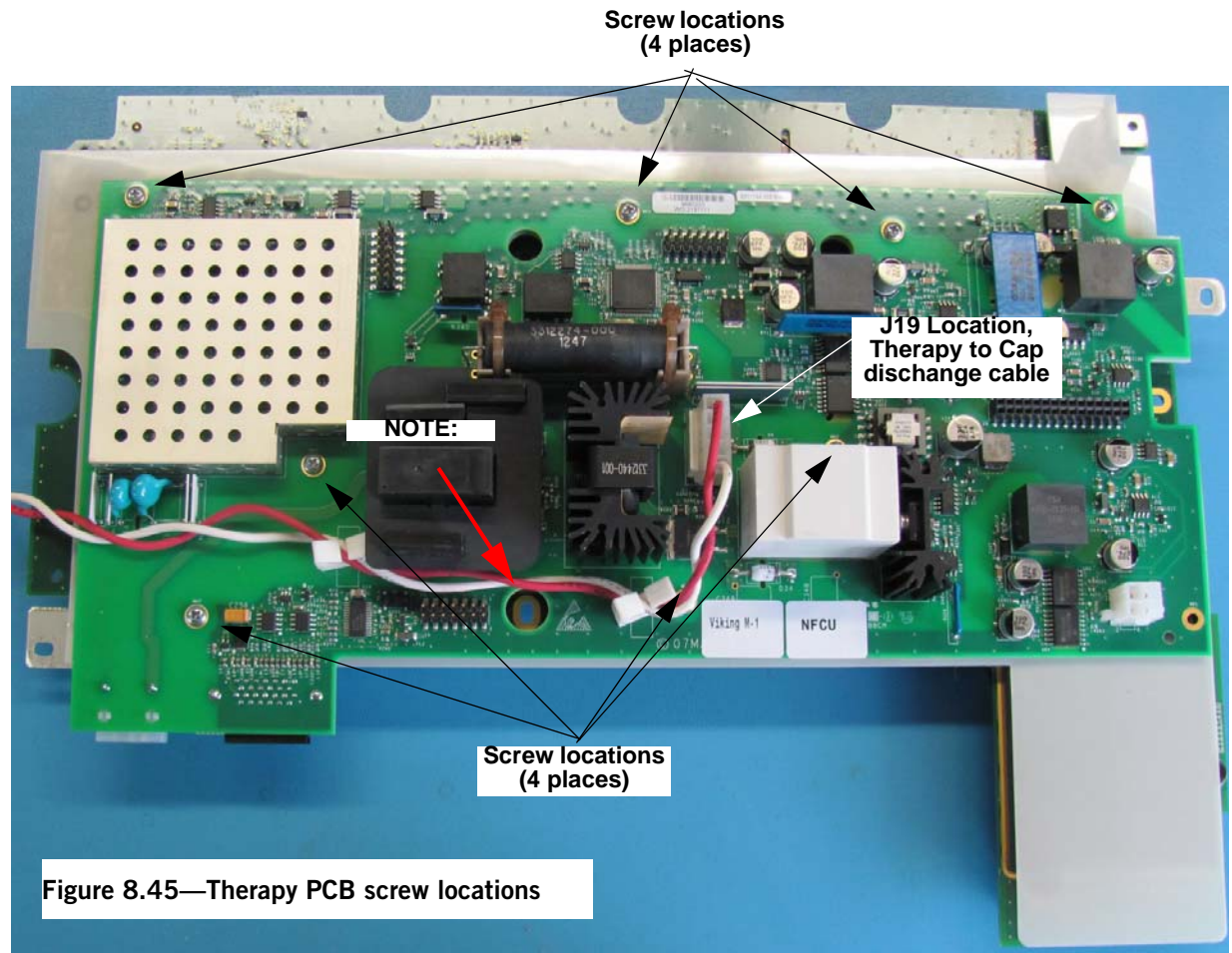

◆ To replace the therapy PCB (A04): *(Continued) 7 steps, (Page 3 of 3)*

6. Follow the instructions to install the system/therapy assembly into device as described in [Installing the System \(A01\)/Therapy \(A04\) PCB Assembly \(p. 238\)](#).
7. Reassemble the case as described in [Reassembling the Case \(p. 186\)](#).

**NOTE:** After device reassembly, complete the TCP–Defibrillator Calibration procedure. The defibrillator calibration constants may be invalidated when you replace Therapy PCB.

### Power PCB (A03) Replacement

Power PCB Replacement consists of the following procedures:

- [Removing the Power PCB \(A03\) \(p. 251\)](#)
- [Installing the Power PCB \(A03\) \(p. 255\)](#)



### Removing the Power PCB (A03)

Some parts mentioned in this procedure are optional and may not apply to your device.

- ◆ To remove the power PCB (A03) from the rear case: *12 steps, (Page 1 of 4)*
  1. Disassemble the case as described in [Disassembling the Case \(p. 183\)](#).
  2. Remove the system/therapy PCB assembly as described in [System \(A01\)/Therapy \(A04\) PCB Assembly Replacement \(p. 234\)](#).
  3. Remove the OEM PCB as described in [Removing the OEM PCB \(A06\) \(p. 262\)](#).
  4. For V4 Power PCB (REF 21330-001531): Disconnect the power/contact (W05) at J12, battery pins/power PCB cable (W10) at J11, and auxiliary power cable (W09) at J15-A and J15-B from the Power PCB.

J12  
connection

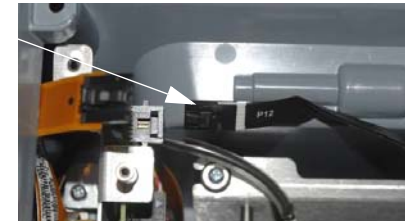

J11 connection  
(W10)

J15-A connection  
(W09)

J15-B connection  
(W09)

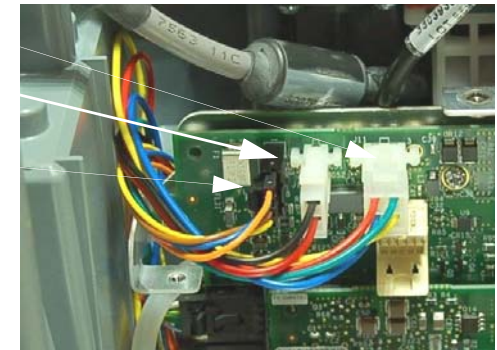
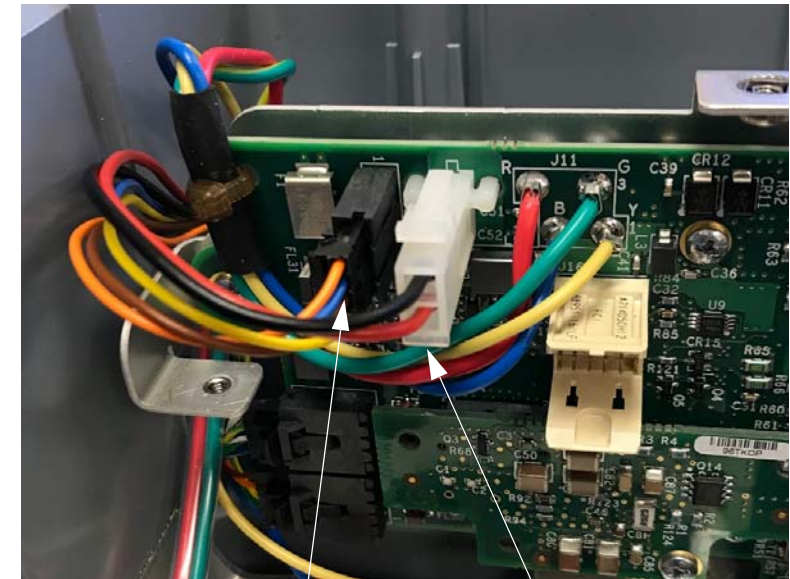

Figure 8.46—Power PCB connections for V4  
(REF 21330-001531)

- ◆ To remove the power PCB (A03) from the rear case: *(Continued) 12 steps, (Page 2 of 4)*
  5. For V4 Power PCB (REF [21330-001555](#)): Disconnect the power/contact (W05) at J12, and auxiliary power cable (W09) at J15-A and J15-B from the Power PCB.



J15-B connection  
(W09)

J15-A connection  
(W09)

**Figure 8.47—Power PCB connections for V4  
(REF [21330-001555](#))**

◆ To remove the power PCB (A03) from the rear case: *(Continued) 12 steps, (Page 3 of 4)*

6. Remove the two screws securing the bracket assembly.  
Discard the screws.
7. Lift the power PCB and bracket partially out of the rear case.  
Use caution not to strain the system connector cable.
8. Disconnect the two W08 - system cable connectors at J9 and J10 from the power PCB.
9. For V4 Power PCB (REF [21330-001555](#)): Remove the Battery Pins/Power PCB Cable as described in [Removing the Battery Pins/Power PCB Cable \(W10\)](#) (p. 321)
10. If you are replacing the power PCB, remove the six screws securing the PCB to the mounting bracket, and then remove the PCB. Discard the screws.

Mounting screws  
(2 places)

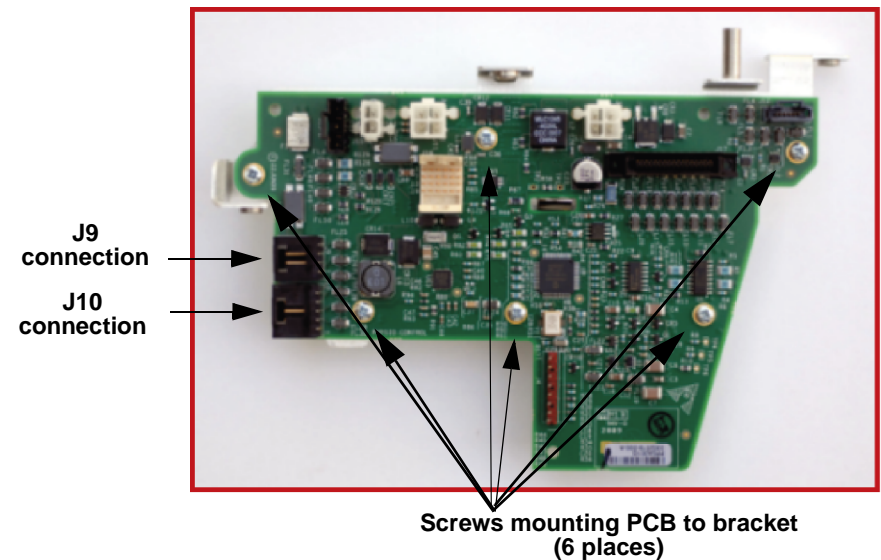
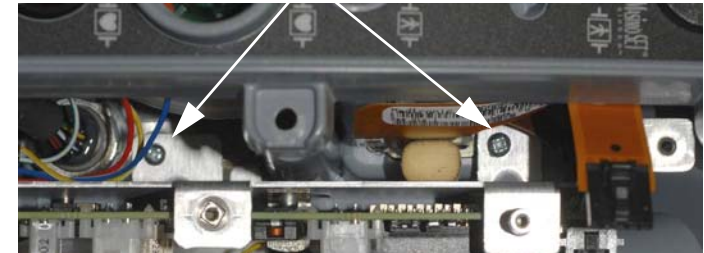

Figure 8.48—Power PCB screw locations (REF 21330-001531)

- ◆ To remove the power PCB (A03) from the rear case: *(Continued) 12 steps, (Page 4 of 4)*
  11. Remove the W01 power/system PCB cable at J17 for reuse with the new power PCB.
  12. Store power PCB in ESD safe container.

J17  
connection

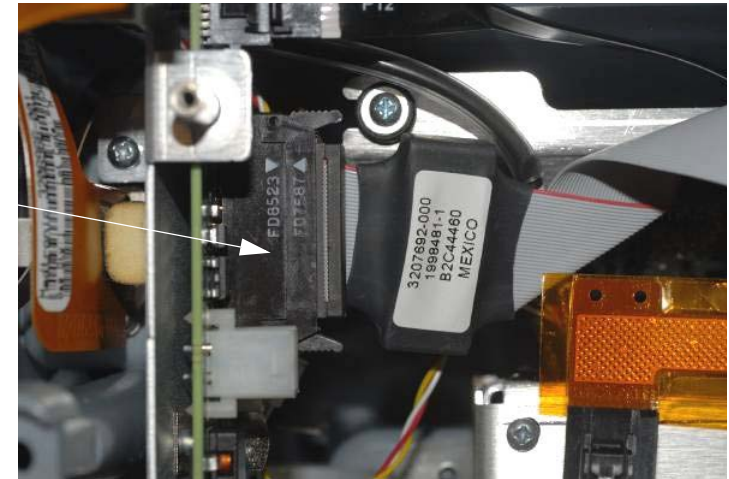

Figure 8.49—Power/system PCB cable

### Installing the Power PCB (A03)

Some parts mentioned in this procedure are optional and may not apply to your device.

- ◆ To install the power PCB (A03) into the rear case: *11 steps, (Page 1 of 6)*

**NOTE:** When installing a new power PCB, use [Power PCBA Repair Kit, V2/V4 \(REF 40577-000043\)](#) (p. 499).

1. Secure the power PCB to the mounting bracket (REF [21330-001257](#)) using the six new screws (REF [21300-001038](#)); torque to 6.8 in-lb.
2. Connect the W08 - system connector cables to J09 and J10. If there is an NIBP option, ensure that the NIBP tube is routed above the W08 system connectors.

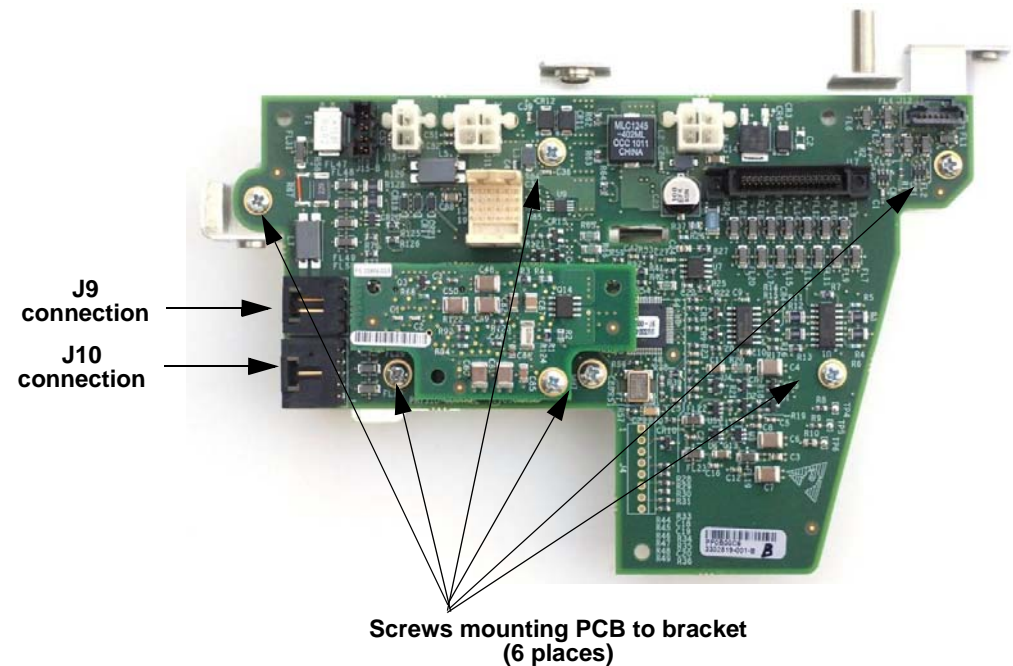

Figure 8.50—Power PCB mounting bracket screw locations (REF 21330-001531)

- ◆ To install the power PCB (A03) into the rear case: *(Continued) 11 steps, (Page 2 of 6)*

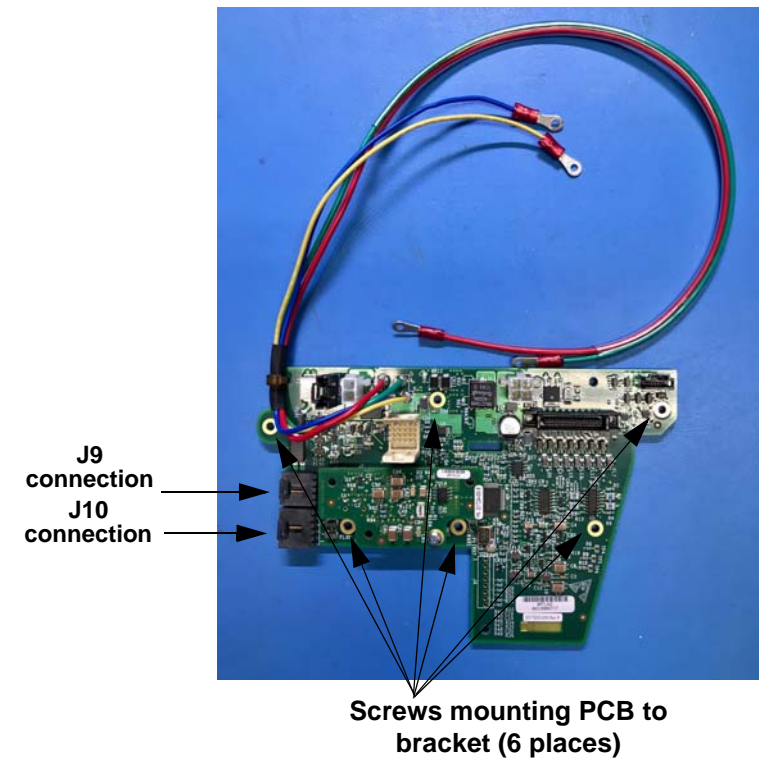

Figure 8.51—Power PCB screw locations (REF [21330-001555](#))

◆ To install the power PCB (A03) into the rear case: *(Continued) 11 steps, (Page 3 of 6)*

3. Mount the power PCB in the case and secure the bracket (REF [21330-001257](#)) to the rear case using two new screws (REF [21300-001038](#)); torque to 6.8 in-lb. For Power PCB (REF [21330-001555](#)), route the Power PCB Cable behind the Power PCB.

**NOTE:** Ensure that the W28 - FRS assembly CO2 tubing/ wiring is above the SpO2 cable and not kinked as it comes through the space provided along right side of the power PCB.

**NOTE:** When installing Power PCB (REF [21330-001555](#)), install the Battery Pins/Power PCB Cable (W10) as described in [Installing the Battery Pins/Power PCB Cable \(W10\)](#) (p. 322)

4. Connect power/contact PCB cable (W05) to the power PCB at J12.



Mounting screws  
(2 places)

Figure 8.52—Power PCB screw locations

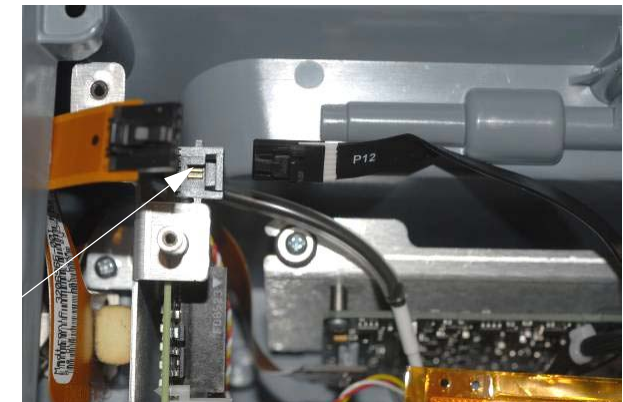

J12  
connection

Figure 8.53—Power PCB J12 connection

- ◆ To install the power PCB (A03) into the rear case: *(Continued) 11 steps, (Page 4 of 6)*
  5. For V4 power PCB (REF 21330-001531): connect battery pins/power PCB cable (W10) to the power board at J11.
  6. Connect the auxiliary cable (W09) 2-pin cable to the power PCB at J15-A. Route the auxiliary power (W09) 4-pin cable over the top of battery pins/power PCB cable (W10) and connect to the power PCB at J15-B.

**NOTE:** Route system connector wires so that they have clearance behind the power PCB.

**PINCH HAZARD:**  
Route W09 cable over  
W10 cable and connect  
to J15. Routing will  
keep wires below rear  
case tab

J11 connection  
(W10)  
J15-A connection  
(W09)  
J15-B connection  
(W09)

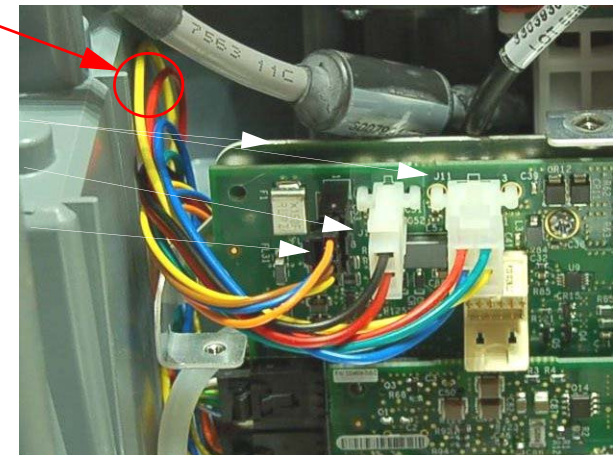

Figure 8.54—Power PCB connections (REF 21330-001531)



- ◆ To install the power PCB (A03) into the rear case: *(Continued) 11 steps, (Page 5 of 6)*

J15-A connection  
(W09)

J15-B connection  
(W09)



Figure 8.55—Power PCB connections (REF [21330-001555](#))

- ◆ To install the power PCB (A03) into the rear case: *(Continued) 11 steps, (Page 6 of 6)*
  7. Route CO2 adapter cable (W30) above the power/system cable as shown.
  8. Connect the power/system cable (W01) at J17.
  9. Install the OEM PCB as described in [Installing the OEM PCB \(A06\) \(p. 265\)](#).
  10. Install the system/therapy PCB assembly as described in [System \(A01\)/Therapy \(A04\) PCB Assembly Replacement \(p. 234\)](#).
  11. Reassemble the case as described in [Reassembling the Case \(p. 186\)](#).

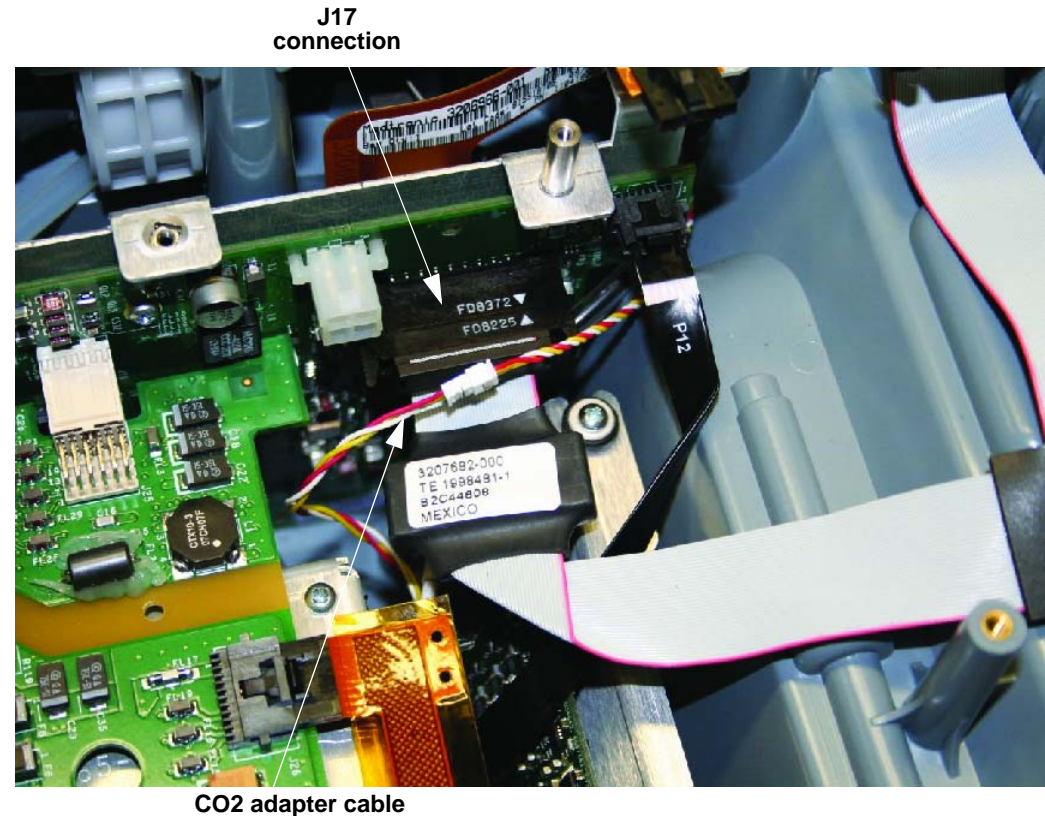

Figure 8.56—Power/system PCB cable (W01)

### OEM PCB (A06) Replacement

OEM PCB Replacement consists of the following procedures:

- [Removing the OEM PCB \(A06\) \(p. 262\)](#)
- [Installing the OEM PCB \(A06\) \(p. 265\)](#)

### Removing the OEM PCB (A06)

Refer to [Inside Rear Case Diagrams \(p. 231\)](#).

- ◆ To remove the OEM PCB (A06) from the rear case: *11 steps, (Page 1 of 3)*
  1. Disassemble the case as described in [Disassembling the Case \(p. 183\)](#).
  2. Remove the system/therapy PCB assembly as described in [System \(A01\)/Therapy \(A04\) PCB Assembly Replacement \(p. 234\)](#).
  3. Disconnect Power/Therapy Cable (W02) from J8 on the power PCB.
  4. Remove the OEM shield.

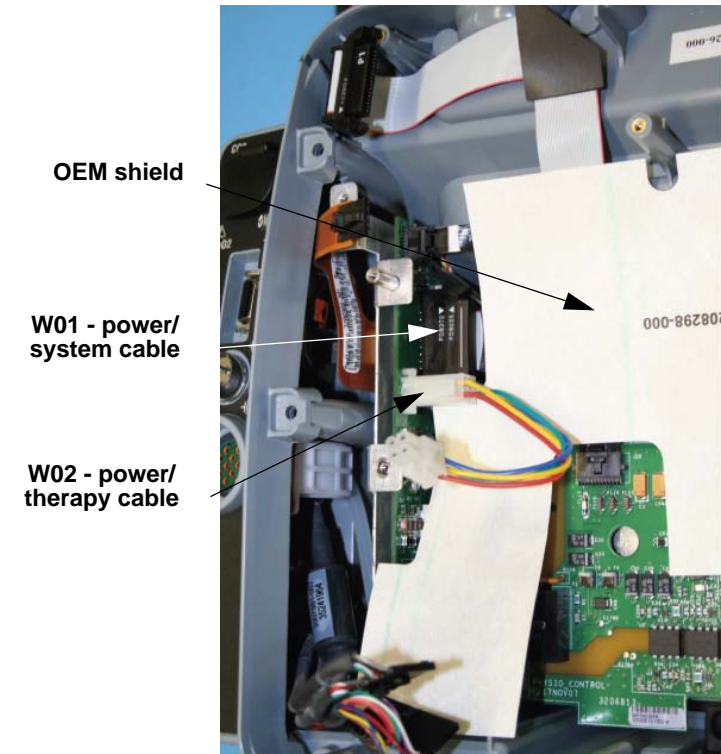

Figure 8.57—OEM PCB shield

- ◆ To remove the OEM PCB (A06) from the rear case: *(Continued) 11 steps, (Page 2 of 3)*
  5. Disconnect the SpO2/OEM cable (W21), if present.
  6. Disconnect the CO2/OEM cable (W26), if present.
  7. Remove the NIBP connector retainer clip and disconnect the NIBP/OEM cable (W27), if present.

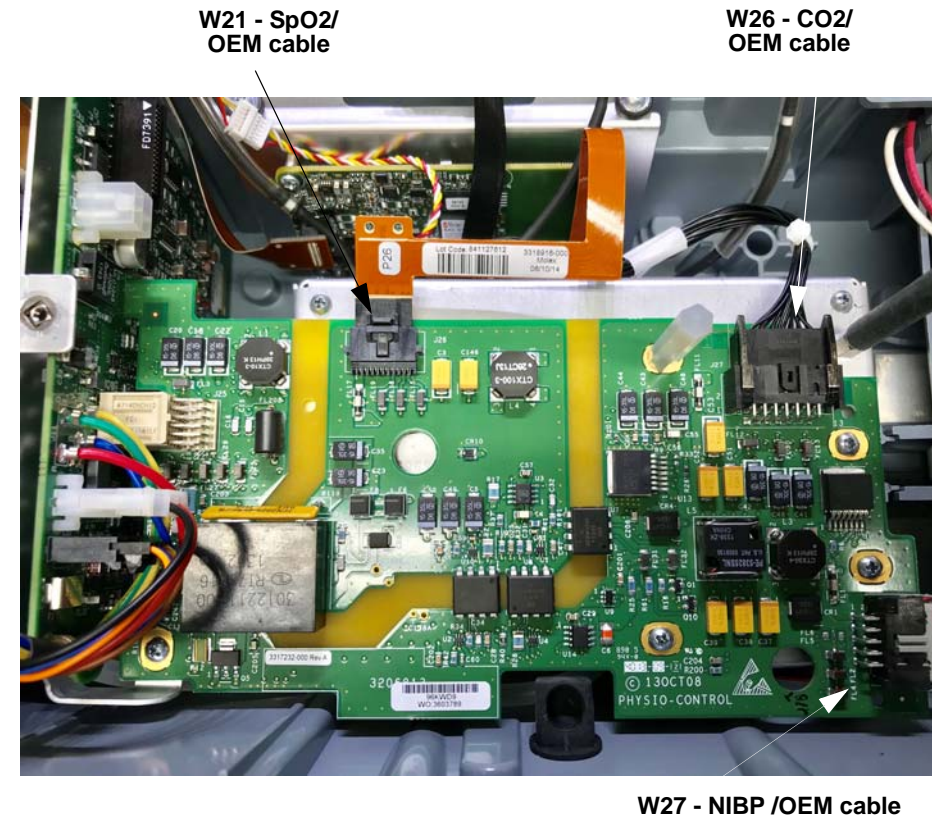

Figure 8.58—OEM PCB connections

- ◆ To remove the OEM PCB (A06) from the rear case: *(Continued) 11 steps, (Page 3 of 3)*
  8. Remove the nylon standoff from the OEM PCB.
  9. Remove the four mounting screws. Discard the screws.
  10. Lift the right edge of the OEM PCB upward slightly, and then slide the PCB to the right (toward the capacitor) to disengage the direct connection between the OEM PCB at J25 and the power PCB at J16.
  11. Lift the OEM board from the rear case. Store OEM PCB in ESD safe container.

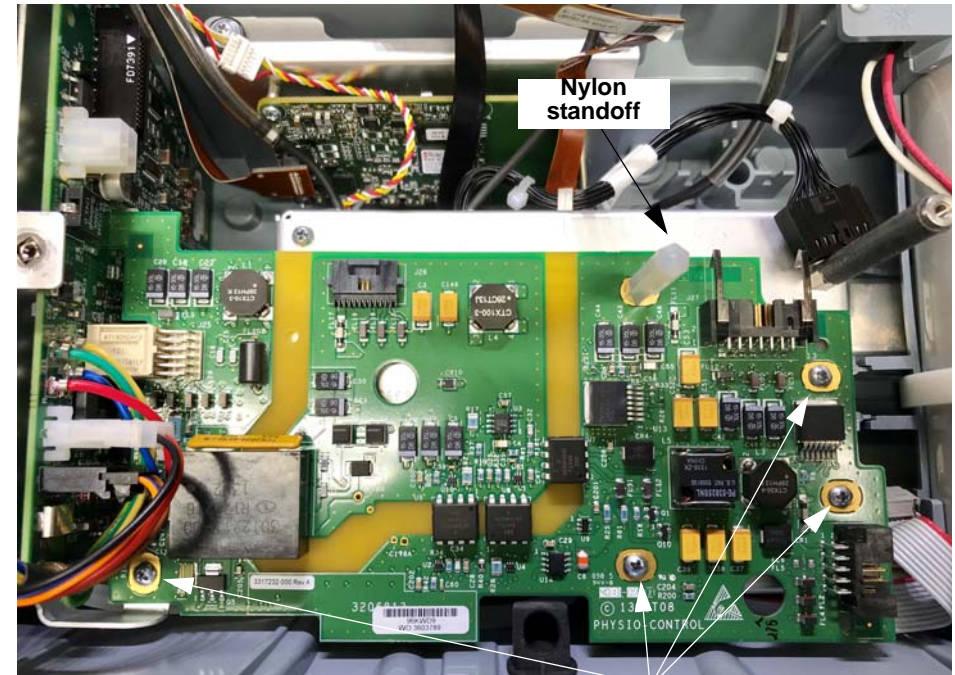

Figure 8.59—OEM PCB screw locations

Mounting screws  
(4 places)

### Installing the OEM PCB (A06)

Refer to [Inside Rear Case Diagrams](#) (p. 231).

◆ To install the OEM PCB (A06) into the rear case: *11 steps, (Page 1 of 3)*

**NOTE:** When installing a new OEM PCB, use either the [OEM PCBA Repair Kit \(REF 40577-000041\)](#) (p. 497).

1. Lift the tab at the upper left corner of the OEM PCB over the ground clip on the power bracket, and then press down on the tab while sliding the OEM PCB to the left to engage the direct connection (J25) to the A03 power PCB at J16.
2. Ensure that the ground tab of the OEM PCB is above the power PCB bracket. Ensure the OEM PCB sits flat on the OEM bracket and presses straight into the power PCB.
3. Install four new screws (REF [21300-001038](#)); torque to 6.8 in-lb.
4. Install the nylon standoff (REF [21300-001402](#)) in the OEM hole (torque to 4.0 in-lb using a 1/4" socket).

J25 connector

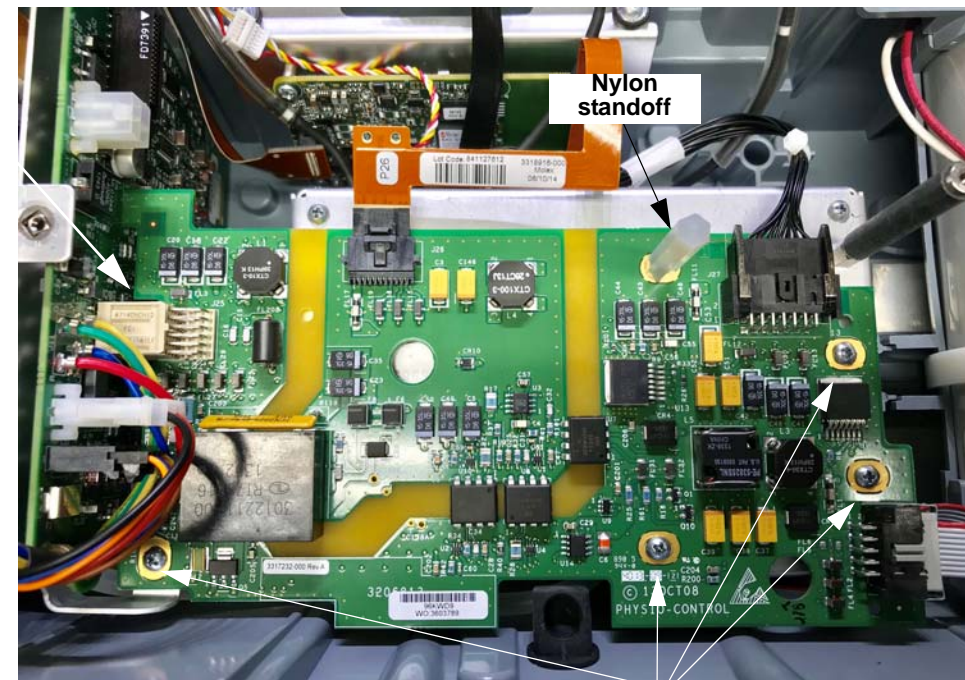

Figure 8.60—OEM PCB screw locations

Mounting screws

- ◆ To install the OEM PCB (A06) into the rear case: *(Continued) 11 steps, (Page 2 of 3)*
  5. If present, connect the SpO2/OEM cable (W21) (REF [21330-001524](#)) to J26 and ensure locking feature is engaged.
  6. If present, connect the CO2/OEM cable (W26) (REF [21330-001217](#)) to J27 and ensure locking feature is engaged.
  7. If present, connect the NIBP/OEM cable (W27) (REF [21330-000235](#)) to J28 and lock into place with the retainer clip (REF [21300-001416](#)).

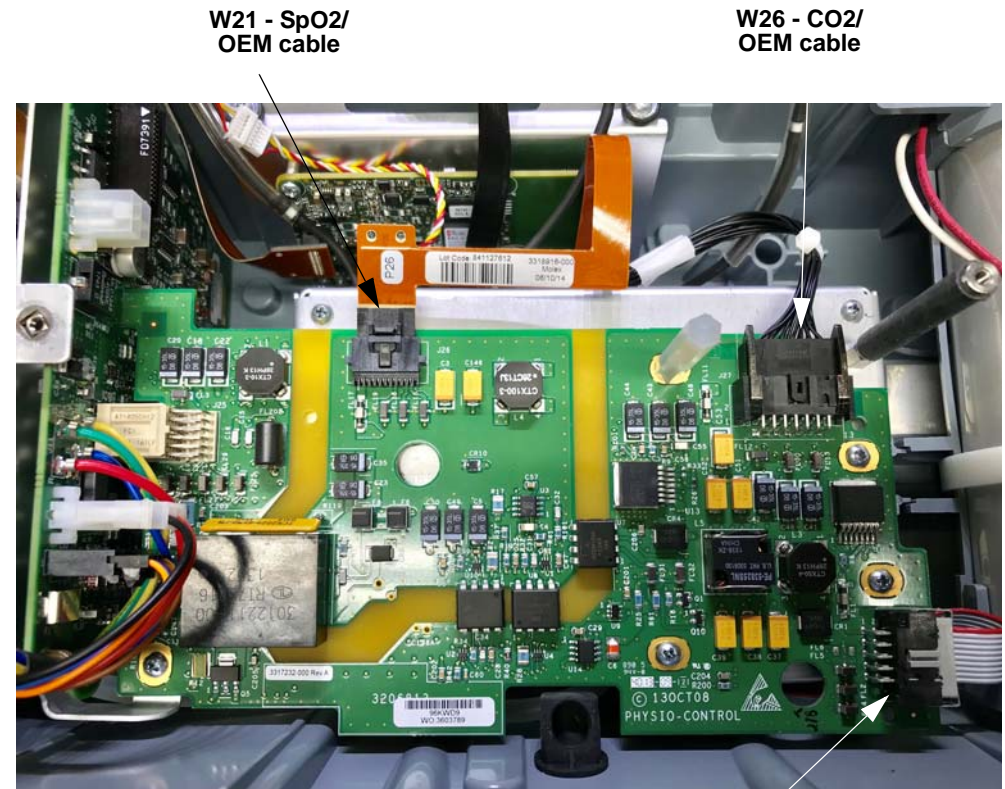

Figure 8.61—OEM PCB connections

W27 - NIBP /  
OEM cable



◆ To install the OEM PCB (A06) into the rear case: *(Continued) 11 steps, (Page 3 of 3)*

**NOTE:** The W01 - power/system PCB cable is under the OEM shield.

8. Install the OEM shield (REF [21300-008127](#)).
9. Connect the W02 - power/therapy PCB cable (REF [21300-001402](#)) to J8 on the power PCB.

**NOTE:** Route the left side of the OEM shield under the power/therapy cable J8 connector and over the top of J13 and J15 connectors on power PCB.

10. Install the system/therapy PCB assembly as described in [System \(A01\)/Therapy \(A04\) PCB Assembly Replacement \(p. 234\)](#).
11. Reassemble the case as described in [Reassembling the Case \(p. 186\)](#).

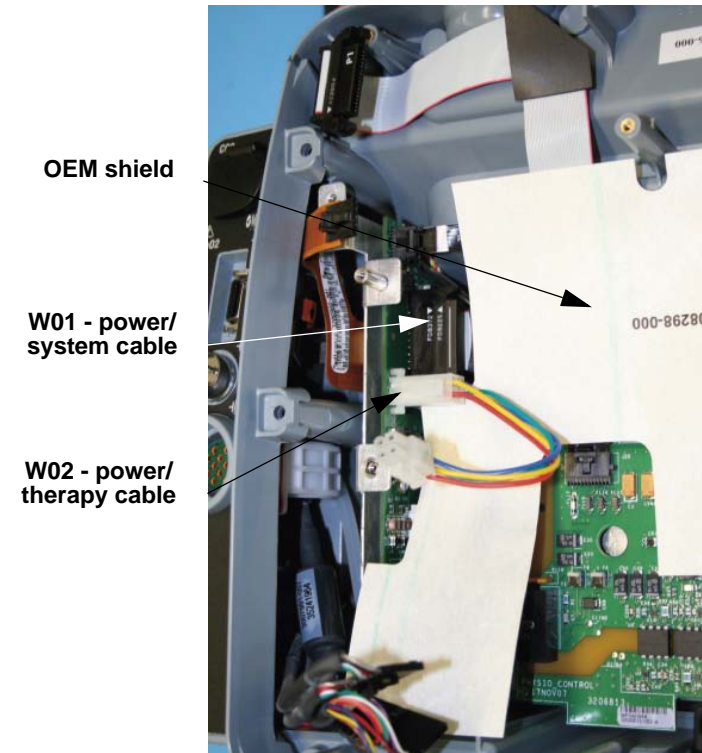

Figure 8.62—OEM PCB shield

### Energy Storage Capacitor (A15) Replacement

Energy storage capacitor replacement consists of the following procedures:

- Removing the Energy Storage Capacitor (A15) (p. 269)
- Installing the Energy Storage Capacitor (A15) (p. 270)

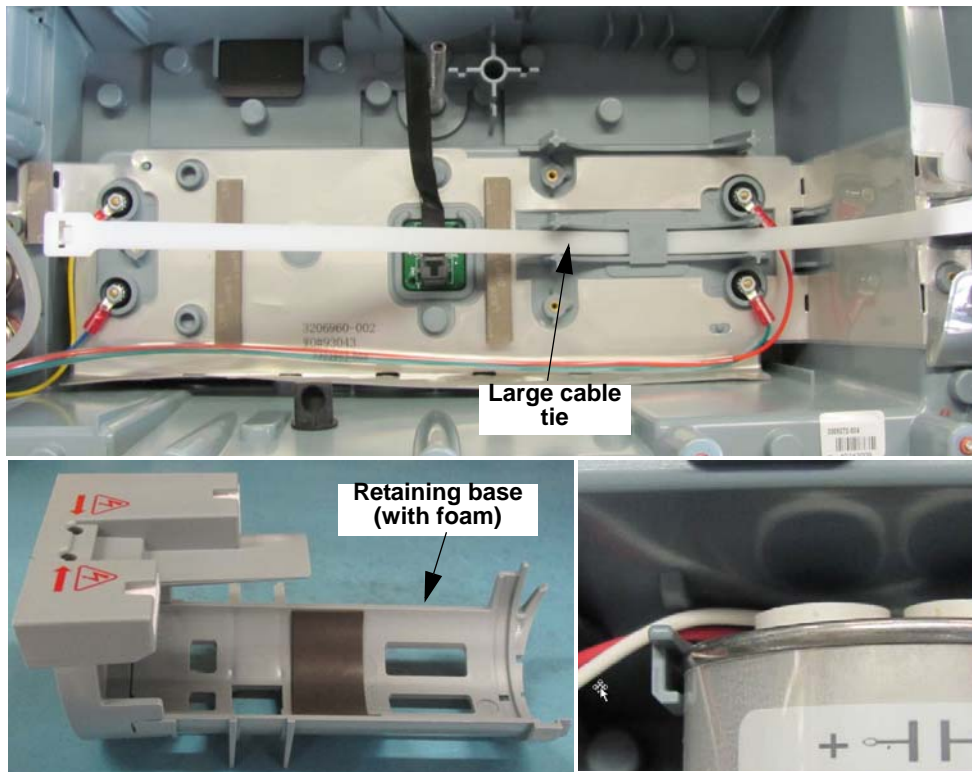
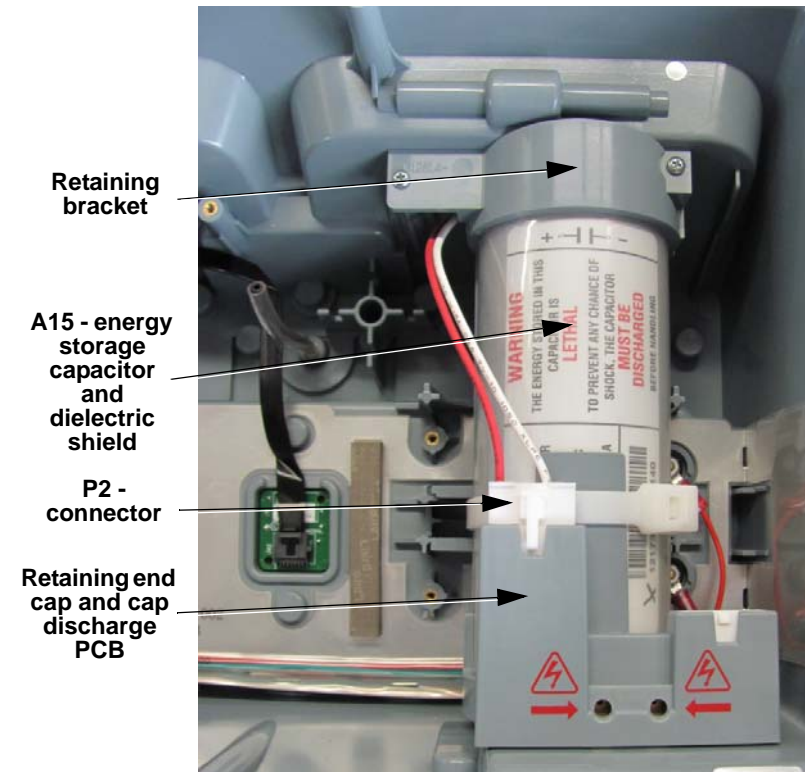

Figure 8.63—Capacitor and Cap Retaining Assembly



### Removing the Energy Storage Capacitor (A15)

- ◆ To remove the Energy Storage Capacitor from the rear case:
  1. Disassemble the case as described in [Disassembling the Case \(p. 183\)](#).
  2. Remove the system/therapy PCB assembly as described in [System \(A01\)/Therapy \(A04\) PCB Assembly Replacement \(p. 234\)](#).
  3. Disconnect the energy storage capacitor connector P2 from the capacitor discharge PCB assembly (left side connector).
  4. Cut the restraining large cable tie from the cap retaining assembly.
  5. Remove the 2 screws that secure the retaining bracket to the rear case.
  6. Lift out the energy storage capacitor and retaining assembly from the rear case.
  7. Separate the retaining base from the retaining end cap assembly.
  8. Remove the energy storage capacitor from the retaining base.
  9. (As needed) Remove the capacitor discharge PCB (A24) from the retaining end cap

### Installing the Energy Storage Capacitor (A15)

◆ To install the Energy Storage Capacitor into the rear case:

**NOTE:** When installing a new energy storage capacitor use the [Internal Hardware Repair Kit \(REF 40577-000003\) \(p. 488\)](#) and [External Hardware Repair Kit \(REF 40577-000004\) \(p. 488\)](#).

1. (As required) Slide the capacitor discharge PCB (A24) (REF [21330-001536](#)) into the retaining end cap.  
**NOTE:** Verify the capacitor discharge PCB is aligned into slots in the retaining end cap; PCB shouldn't bind in the slots.
2. (As required) Remove the adhesive liner and install capacitor foam pad onto the retaining base.
3. Install retaining base (REF [21330-008122](#)) into slots in retaining end cap assembly.
4. With the dielectric shield in place, install the energy storage capacitor (A15) (REF [21300-004232](#)) into the retaining base assembly.
5. Thread large tie wrap (REF [21300-000504](#)) through left side of hole in rear case.
6. Place energy storage capacitor with retaining base assembly into the rear case.  
**NOTE:** Ensure that the energy storage capacitor warning label is facing up.
7. Route the energy storage capacitor wires through slit in cap retaining base and along left side of capacitor body.
8. Install retaining bracket (REF [21330-008121](#)) with 2 screws (REF [21300-001038](#)) and torque to 6.8 in-lbs.
9. Secure the energy storage capacitor and cap retaining assembly to the rear case with the large cable tie (REF [21330-001504](#)).
10. Connect energy storage capacitor connector to capacitor discharge PCB assembly at J2 (left connector).
11. Install the system/therapy PCB assembly as described in [System \(A01\)/Therapy \(A04\) PCB Assembly Replacement \(p. 234\)](#).
12. Reassemble the case as described in [Reassembling the Case \(p. 186\)](#).

### SpO2 PCB (A16) Replacement

SpO2 PCB Replacement consists of the following procedures:

- [Removing the SpO2 PCB \(A16\) \(p. 272\)](#)
- [Installing the SpO2 PCB \(A16\) \(p. 276\)](#)

### Removing the SpO2 PCB (A16)

- ◆ To remove the SpO2 PCB from the rear case (see [Figure 9.21 on p. 398](#)): 14 steps, (Page 1 of 4)
  1. Disassemble the case as described in [Disassembling the Case \(p. 183\)](#).
  2. Remove the system/therapy PCB assembly as described in [System \(A01\)/Therapy \(A04\) PCB Assembly Replacement \(p. 234\)](#).
  3. Remove the OEM shield.
  4. Disconnect the power/contact PCB cable (W05) from the power board J12.
  5. Remove power/system cable (W01) from the power board J17.
  6. Remove the power/therapy cable (W02) from J8 on the power PCB.

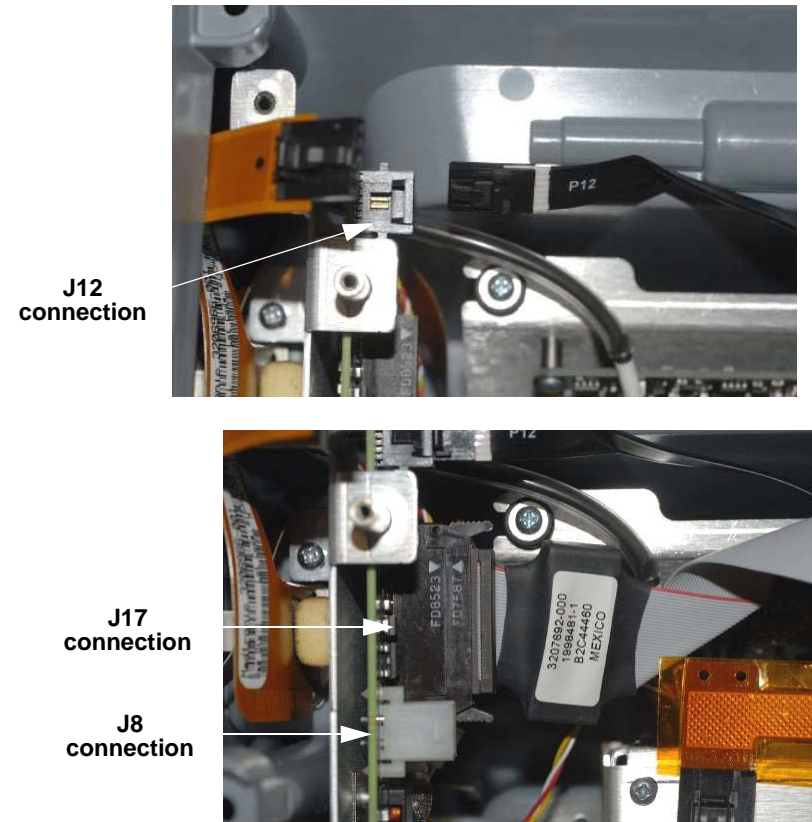

Figure 8.64—Power/system PCB connections

- ◆ To remove the SpO2 PCB from the rear case (see [Figure 9.21 on p. 398](#)): (Continued) 14 steps, (Page 2 of 4)
  7. Disconnect the SpO2/OEM cable (W21) from OEM PCB J26.
  8. Carefully disconnect the SpO2 connector flex cable (W22) from J1 of SpO2 PCB.
  9. Remove the two screws securing the mounting bracket. Discard the screws.
  10. Lift the SpO2 assembly out of the rear case.

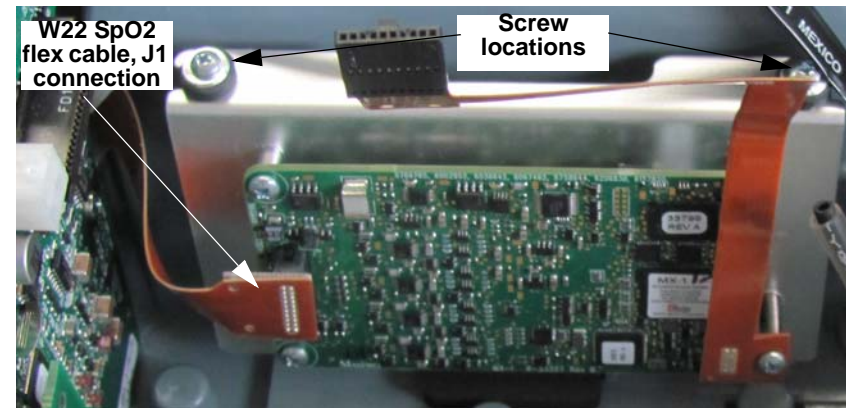

Figure 8.65—SpO2 PCB connections

### CAUTION

**POSSIBLE COMPONENT DAMAGE** The SpO2 connector flex cable can be damaged during disassembly. If SpO2 connector is damaged, replace the SpO2 flex cable using the [MASIMO SpO2 Panel Mount Cable Repair Kit \(REF 40577-000025\)](#) (p. 495).

- ◆ To remove the SpO2 PCB from the rear case (see [Figure 9.21 on p. 398](#)): *(Continued) 14 steps, (Page 3 of 4)*
  11. To remove the SpO2 flex cable, remove the one screw attaching the SpO2/OEM flex cable (W21) from the SpO2 module. Discard the screw.
  12. Disconnect SPO2 flex cable from SPO2 Module.

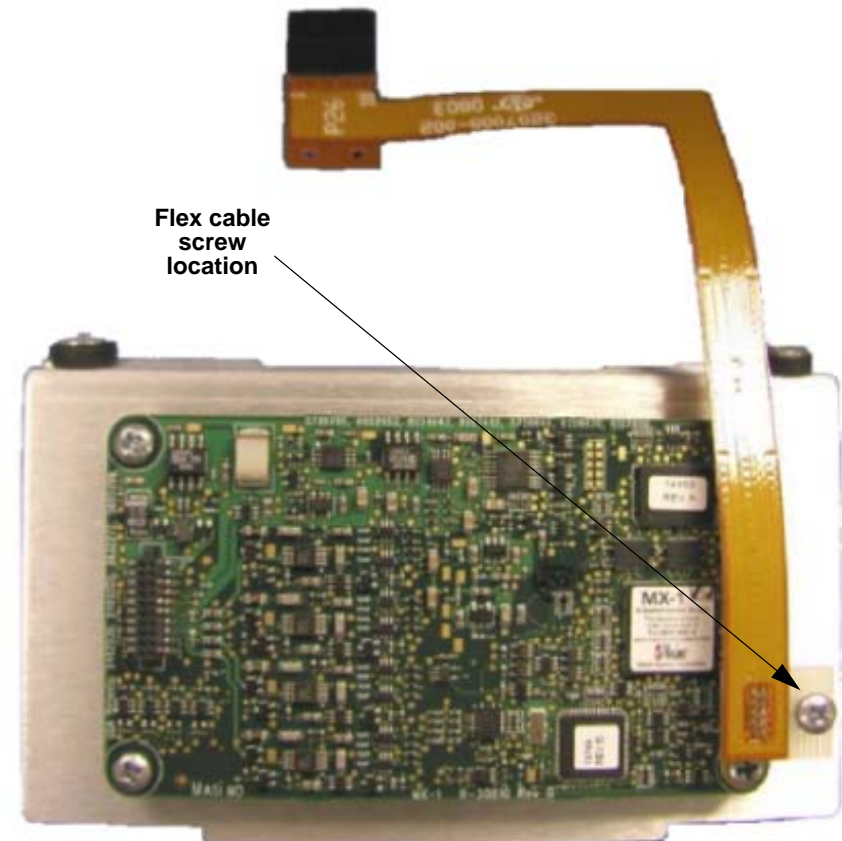

Figure 8.66—SpO2 flex cable screw



- ◆ To remove the SpO2 PCB from the rear case (see [Figure 9.21 on p. 398](#)): *(Continued) 14 steps, (Page 4 of 4)*
  13. To remove the SpO2 module from the bracket, remove the four screws that attach the SpO2 module to the mounting bracket. Discard the screws.
  14. Lift the SpO2 module off of the mounting bracket. Store the SpO2 module in a ESD safe container.

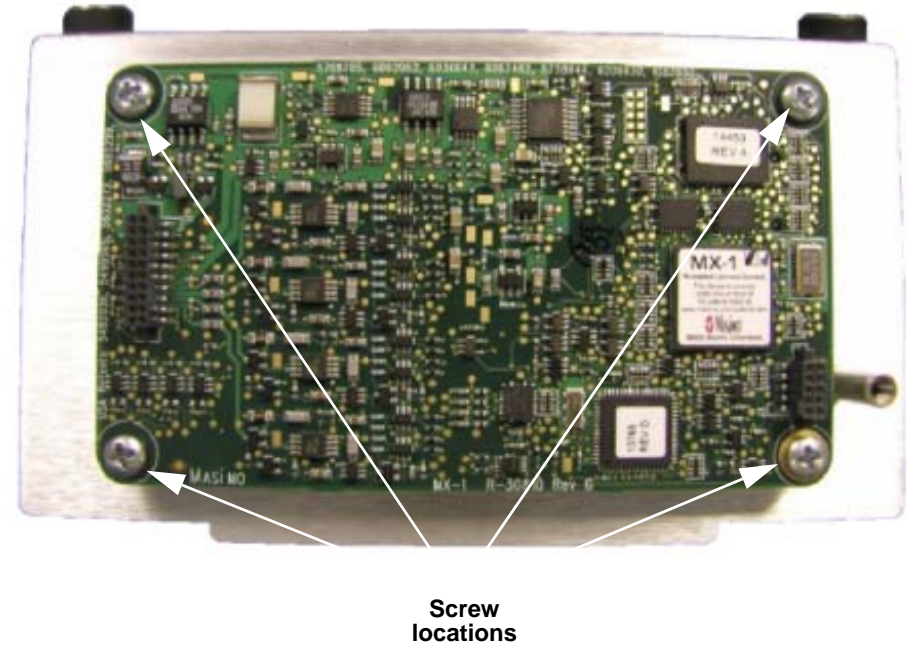

Figure 8.67—SpO2 PCB screw locations

### Installing the SpO2 PCB (A16)

**NOTE:** When installing a new SpO2 PCB, use the [MASIMO SpO2 Module Repair Kit \(REF 40577-000039\)](#) (p. 494).

◆ To install the SpO2 Module in the rear case (see [Figure 9.21 on p. 398](#)): *13 steps, (Page 1 of 5)*

1. Install the SpO2 module (REF [21330-001530](#)) on the mounting bracket.
2. Attach the SpO2 module to the bracket using four new screws (REF [21300-006251](#)); torque to 4.0 in-lb (see [Figure 8.67 on p. 275](#)).
3. Attach the SpO2/OEM flex cable (W21) (REF [21330-001524](#)) to the SpO2 module using one new screw (REF [21300-006251](#)); torque to 4.0 in-lb.
4. Connect the SpO2 connector flex cable (W22) (REF [21330-001290](#)) to J1 of the SpO2 PCB.

**NOTE:** If installing the SpO2 connector flex cable (W22), refer to [SpO2 Connector Cable \(W22\) Replacement \(p. 329\)](#).

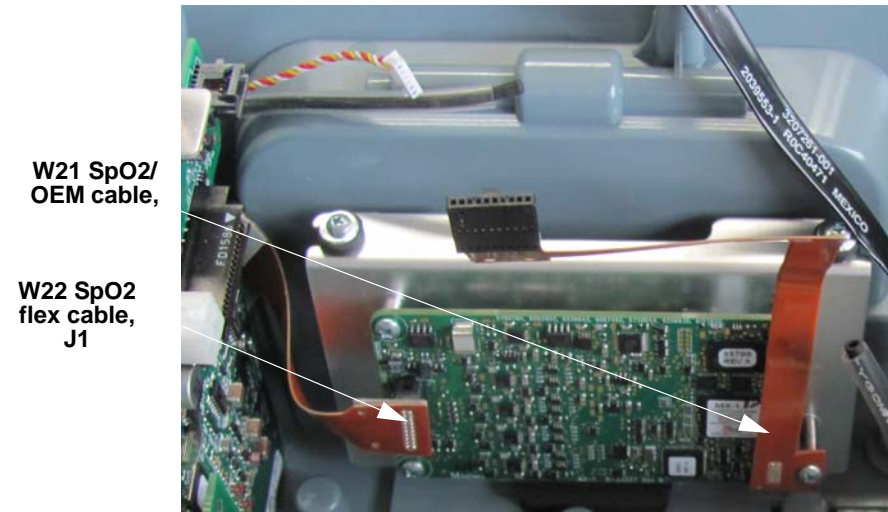

Figure 8.68—SpO2 PCB connection

- ◆ To install the SpO2 Module in the rear case (see [Figure 9.21 on p. 398](#)): *(Continued) 13 steps, (Page 2 of 5)*
  5. Install the mounting bracket (REF [21300-007550](#)) using two new screws (REF [21300-004599](#)); torque to 6.8 in-lb.

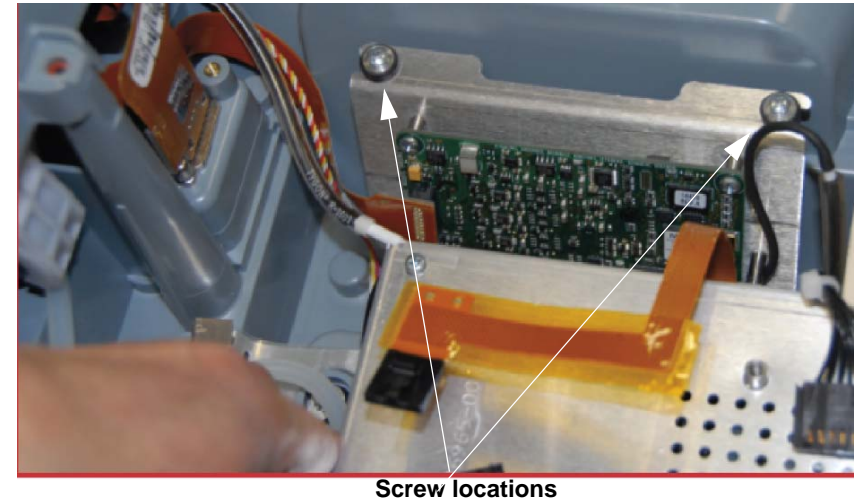

Figure 8.69—SpO2 mounting bracket

- ◆ To install the SpO2 Module in the rear case (see [Figure 9.21 on p. 398](#)): *(Continued) 13 steps, (Page 3 of 5)*
  6. Connect the SpO2/OEM cable (W21) (REF [21330-001524](#)) to the OEM PCB at J26.
  7. Connect the power/contact cable (W05) to the power board at J12.

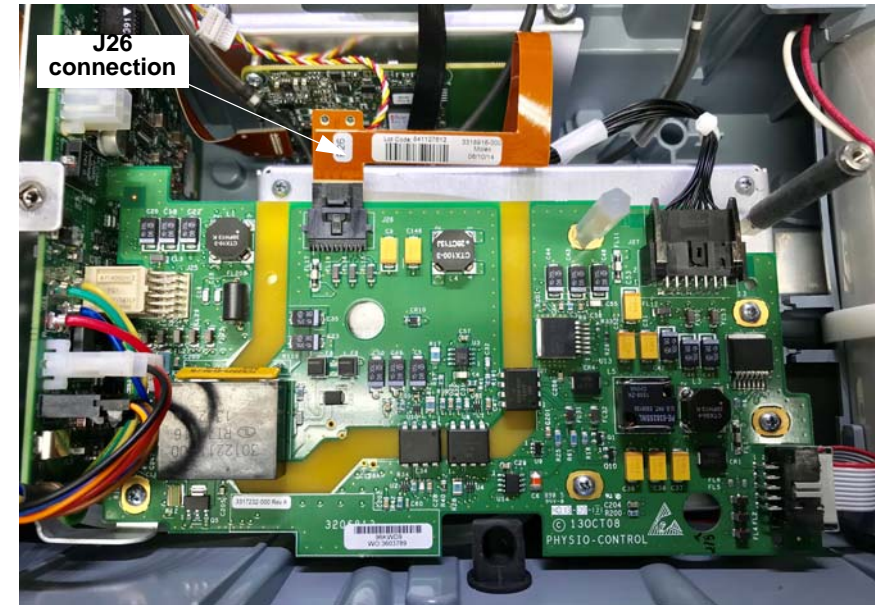

Figure 8.70—SpO2 connection to OEM PCB

- ◆ To install the SpO2 Module in the rear case (see [Figure 9.21 on p. 398](#)): *(Continued) 13 steps, (Page 4 of 5)*



Figure 8.71—Power PCB J12 connection

- ◆ To install the SpO2 Module in the rear case (see [Figure 9.21 on p. 398](#)): *(Continued) 13 steps, (Page 5 of 5)*
  8. Route CO2 adapter cable (W30) above the power/system cable as shown.
  9. Install power/system cable (W01) to the power board at J17.
  10. Install the OEM shield (REF [21300-008127](#)). Route below the J8 and J15 connectors.
  11. Install the power/therapy cable (W02) (REF [21300-001373](#)) to J8 on the power PCB.
  12. Install the system/therapy PCB assembly as described in [System \(A01\)/Therapy \(A04\) PCB Assembly Replacement \(p. 234\)](#).
  13. Reassemble the case as described in [Reassembling the Case \(p. 186\)](#).

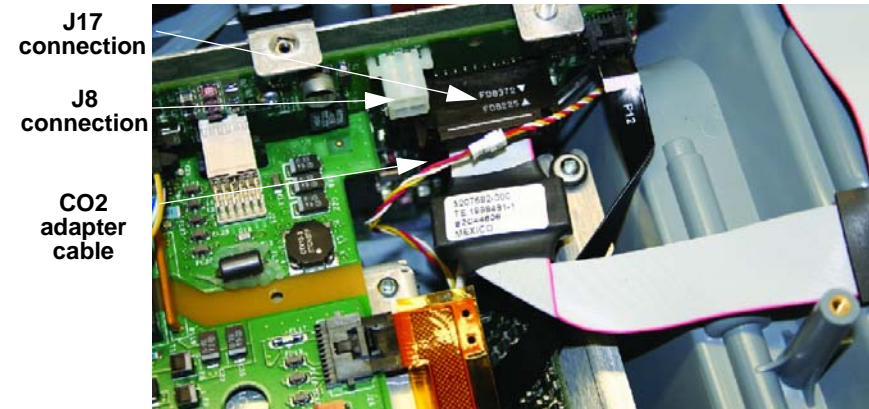

Figure 8.72—Power/system PCB connections

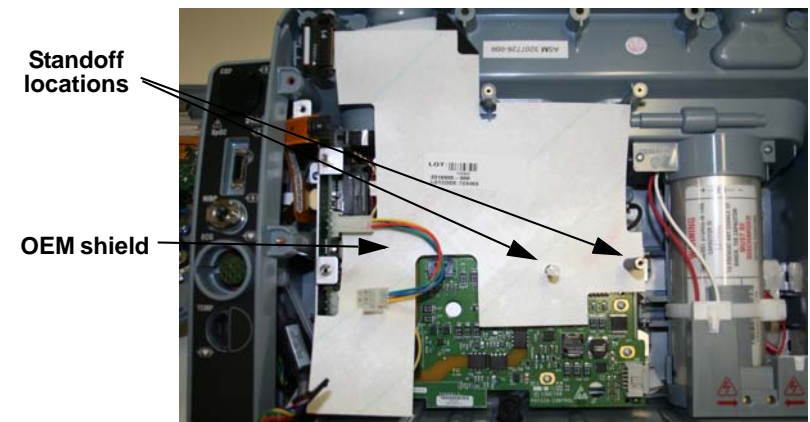

Figure 8.73—OEM shield

### **NIBP (A21)/CO2 (A23) Module Replacement**

NIBP/CO2 module replacement consists of the following procedures:

- [Removing the NIBP \(A21\)/CO2 \(A23\) Modules \(p. 282\)](#)
- [Installing the NIBP \(A21\)/CO2 \(A23\) Modules \(p. 286\)](#)

### Removing the NIBP (A21)/CO2 (A23) Modules

To remove the NIBP and CO2 modules as a unit from the rear case: *20 steps, (Page 1 of 4)*

1. Disassemble the case as described in [Disassembling the Case \(p. 183\)](#).
2. Remove the system/therapy PCB assembly as described in [System \(A01\)/Therapy \(A04\) PCB Assembly Replacement \(p. 234\)](#).
3. Remove the OEM PCB as described in [Removing the OEM PCB \(A06\) \(p. 262\)](#).
4. Remove the power/contact cable (W05) to the power PCB at J12.
5. Remove the three mounting bracket screws. Discard the screws.
6. If present, disconnect the CO2 exhaust tube. Lift the assembly as needed.

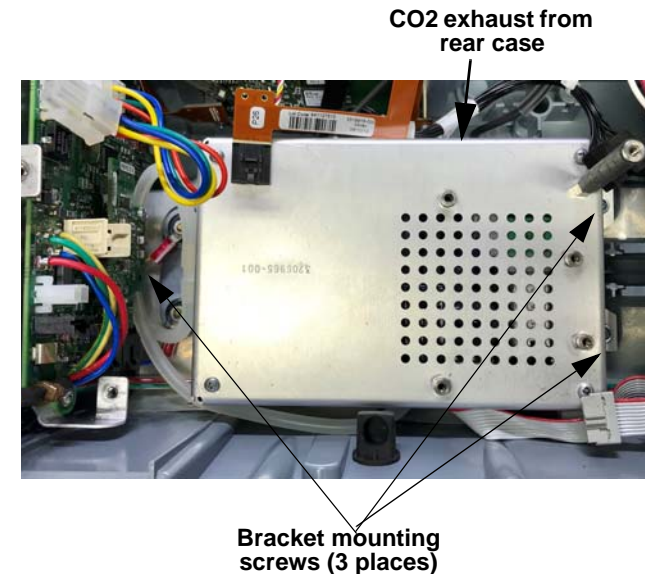

Figure 8.74—CO2/NIBP mounting bracket



To remove the NIBP and CO2 modules as a unit from the rear case: *(Continued) 20 steps, (Page 2 of 4)*

7. If present, disconnect the CO2 inlet tube. Lift the assembly as needed.
8. If present, disconnect the CO2 cable connector inlet cable connector (W28) from CO2 adapter cable (W30).
9. If present, disconnect the NIBP inlet tube. Lift the assembly as needed.
10. Lift the mounting bracket and cover from the rear case.

**W28-W30  
CO2 inlet cable  
connector**

**CO2 inlet tube**

**CO2 hose from  
module**



Figure 8.75—CO2 module connections

To remove the NIBP and CO2 modules as a unit from the rear case: *(Continued) 20 steps, (Page 3 of 4)*

11. For the NIBP option disassembly, remove the NIBP cable (W27) from cable guide on bracket cover.
12. Remove the four screws (REF 21300-006251) from the bracket cover (REF 21330-001195) and lift off the cover. Discard the screws.
13. To remove the NIBP sub-assembly (REF 21330-001556, remove the four screws (REF 21300-006251) and lift the assembly off the OEM bracket. Discard the screws.
14. Disconnect the OEM PCB/NIBP module cable (W27) from the A21 NIBP PCB at J2.
15. Store NIBP module in a ESD safe container.

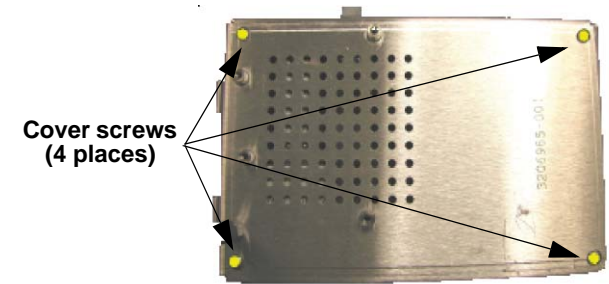

Figure 8.76—Bracket cover screw locations

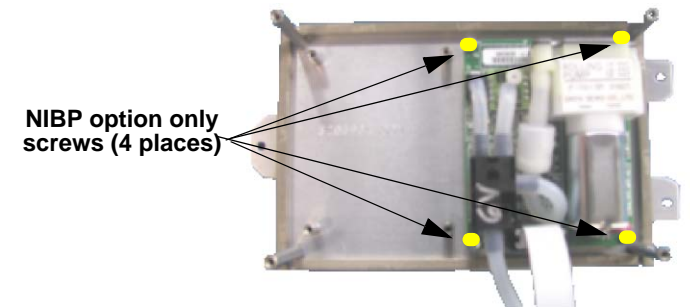

Figure 8.77—NIBP sub-assembly screw locations

To remove the NIBP and CO2 modules as a unit from the rear case: *(Continued) 20 steps, (Page 4 of 4)*

16. To remove the CO2 sub-assembly, remove the four screws and lift the assembly off the OEM bracket. Discard the screws.
17. Disconnect the OEM PCB/CO2 module cable from the CO2 PCB (A23) at J4.
18. Disconnect OEM PCB/CO2 module cable from microwire saddle clip on side of case.
19. Disconnect the CO2 adapter cable from the CO2 PCB (A23) at J1.
20. Store the CO2 module in a ESD safe container.

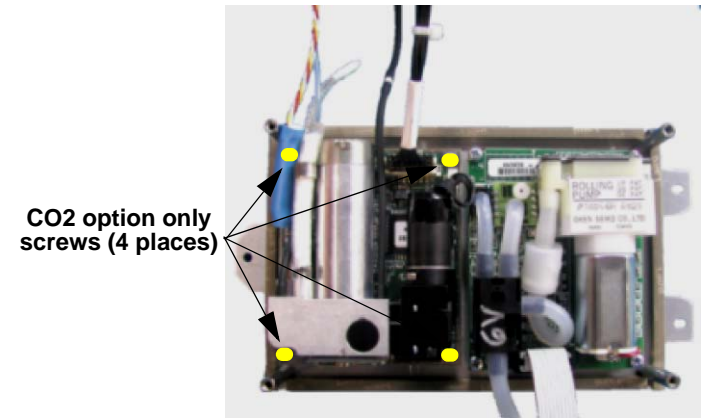

Figure 8.78—CO2 sub-assembly screw locations

### CAUTION

**POSSIBLE SKIN BURNS** Do not open the CO2 scrubber device (part of the CO2 module). Scrubber material may cause caustic burns. If scrubber material comes in contact with skin, rinse the area of contact thoroughly with water. If scrubber material comes in contact with eyes, flush eyes with water for 15 minutes, and then seek immediate medical attention.

### Installing the NIBP (A21)/CO2 (A23) Modules

◆ To install the A21 NIBP, A23 CO2, and SpO2 PCBs: *15 steps, (Page 1 of 5)*

1. For NIBP option:

**NOTE:** When replacing the NIBP module, use [NIBP Module Repair Kit \(REF 40577-000045\) \(p. 480\)](#) or [NIBP MAXIQ 5.2 Repair Kit \(REF 40577-000036\) \(p. 481\)](#).

- a. Attach the NIBP module sub-assembly (REF [21330-001556](#)) to the OEM bracket (REF [21330-001195](#)) with four new screws (REF [21300-006251](#)); torque to 4 in-lb.
- b. Connect the OEM PCB/NIBP module cable (REF [21330-000235](#)) to the A21 NIBP PCB at J2.

2. For CO2 option:

**NOTE:** When replacing the CO2 module, use [CO2 Module Repair Kit \(REF 40577-000035\) \(p. 483\)](#).

- a. Attach the CO2 module (REF [21330-001535](#)) to the mounting bracket with four new screws (REF [21300-006251](#)); torque to 4 in-lb.

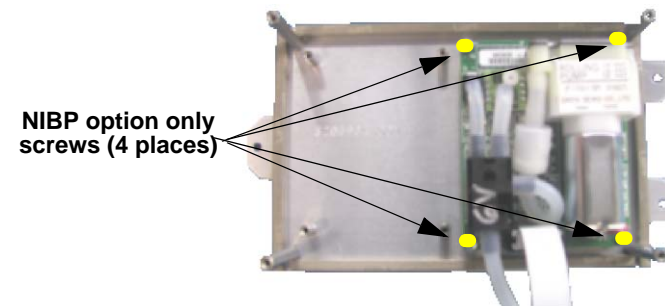

Figure 8.79—NIBP module

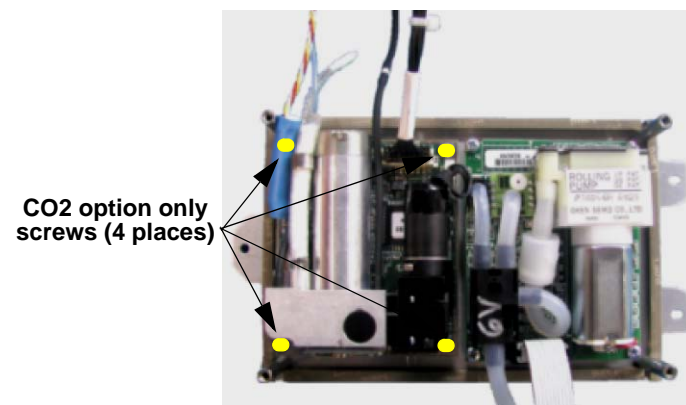
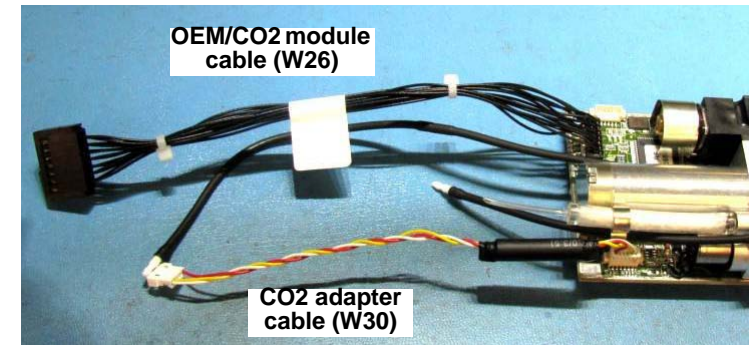

Figure 8.80—CO2 sub-assembly screw locations

- ◆ To install the A21 NIBP, A23 CO2, and SpO2 PCBs: *(Continued) 15 steps, (Page 2 of 5)*
  - b. Connect the CO2 adapter cable (REF [21330-000237](#)) (W30) to the A23 CO2 PCB at J1.
  - c. Connect the OEM PCB/CO2 module cable (REF [21330-001217](#)) (W26) to the A23 CO2 PCB at J4.
- 3. For the NIBP option, route the NIBP cable through the cable mount on side of bracket cover. Ensure that the cable and tubing are not pinched.
- 4. For the CO2 option, route the CO2 tubing and CO2 adapter cable as shown. Ensure that the cable and tubing are not pinched when installing the bracket cover.
- 5. Attach the CO2 module cable (W26) to the microwire saddle clip as shown below.



Microwire saddle clip



NIBP hose and cable routing

CO2 tubing and cable routing

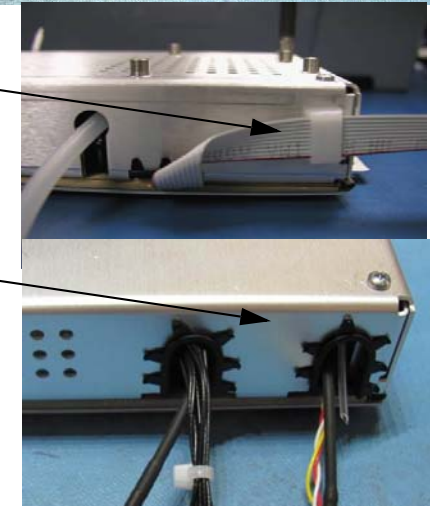

Figure 8.81—CO2 cable connection and tubing and cable locations

- ◆ To install the A21 NIBP, A23 CO2, and SpO2 PCBs: *(Continued) 15 steps, (Page 3 of 5)*
  6. Attach the bracket cover to the OEM bracket with four new screws (REF [21300-006251](#)); torque to 4.0 in-lb.
  7. Place the OEM bracket into rear case and secure with the three new mounting screws (REF [21300-007297](#)); torque to 6.8 in-lb.

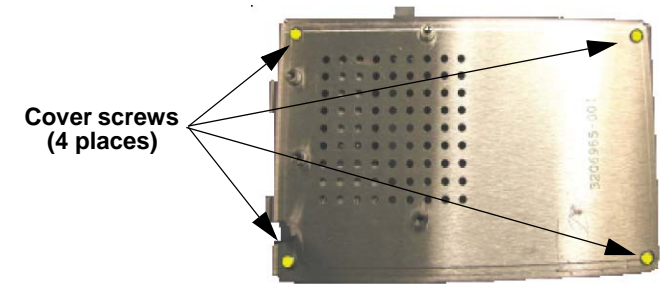

Figure 8.82—Bracket cover screw locations

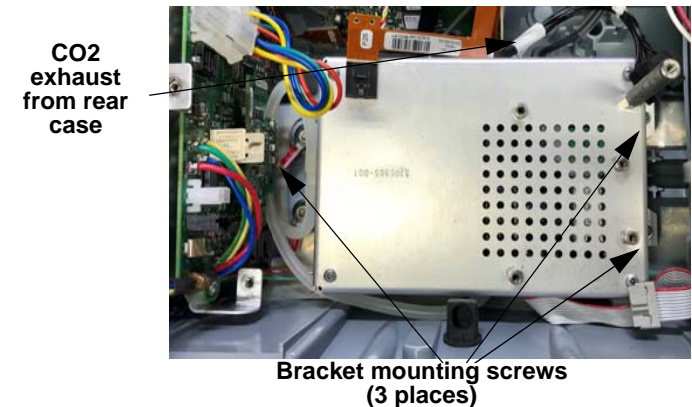
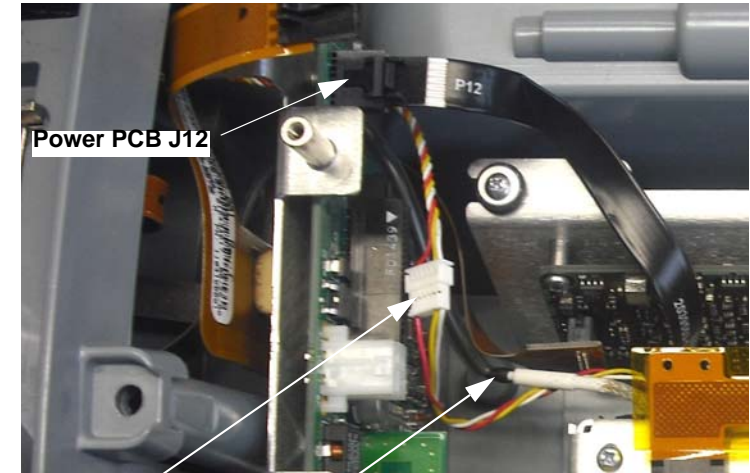

Figure 8.83—CO2/NIBP mounting bracket

- ◆ To install the A21 NIBP, A23 CO2, and SpO2 PCBs: *(Continued) 15 steps, (Page 4 of 5)*
  8. For the NIBP option, connect the NIBP hose from the module to the inlet fitting. Route excess tubing as shown. Ensure that the NIBP tubing is routed through the hole in the bracket cover.
  9. For the CO2 option, connect CO2 module tube to CO2 inlet tube.
  10. For the CO2 option, connect CO2 inlet cable (W28) to CO2 adapter cable (W30).
  11. Connect the power/contact cable (W05) to the power PCB at J12.



W28-W30  
CO2 inlet cable  
connector

CO2 inlet tube

Figure 8.84—CO2 module connections

- ◆ To install the A21 NIBP, A23 CO2, and SpO2 PCBs: *(Continued) 15 steps, (Page 5 of 5)*
  12. For the CO2 option, connect the exhaust tube to the rear case outlet connector.
  13. Install the OEM PCB as described in [Installing the OEM PCB \(A06\) \(p. 265\)](#).
  14. Install the system/therapy PCB assembly as described in [System \(A01\)/Therapy \(A04\) PCB Assembly Replacement \(p. 234\)](#).
  15. Reassemble the case as described in [Reassembling the Case \(p. 186\)](#).

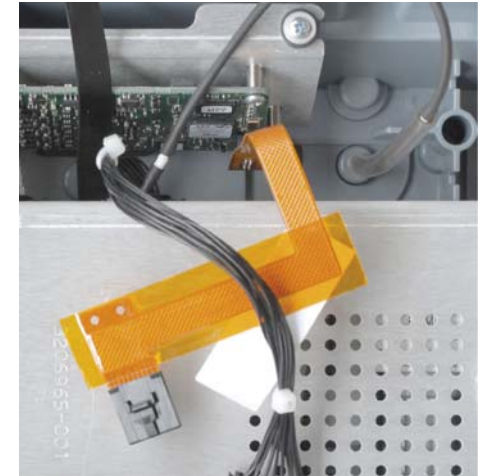
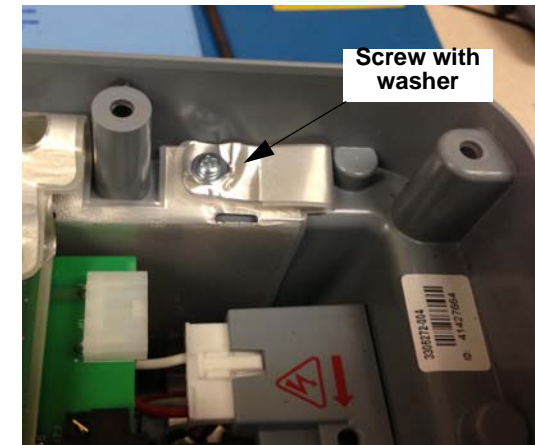
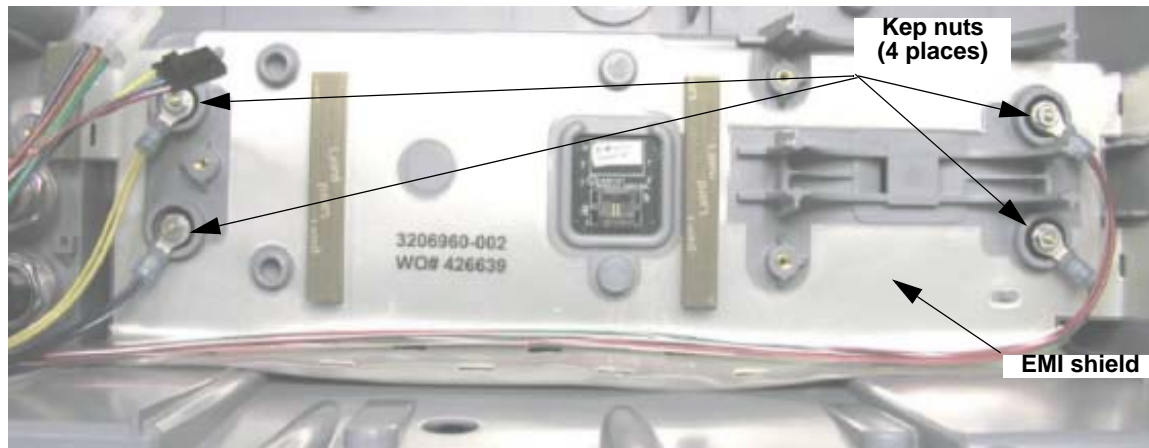

Figure 8.85—CO2 exhaust tube connection



### EMI Shield Replacement

- ◆ The shield is supplied as part of the rear case. Follow the instructions in the [Battery Pins / Power PCB Cable \(W10\) Replacement \(p. 320\)](#) procedure to remove the EMI shield.



**Figure 8.86—EMI shield and battery wire harness nut locations**

- ◆ To install the EMI shield, reverse the steps in the [Rear Case Replacement \(p. 301\)](#) procedure, using the following guidelines.
  1. Pre-fold EMI shield (REF [21330-001190](#)) by placing the shield into the rear case.
  2. Remove adhesive liners and secure EMI shield with Adhesive patches to case.
  3. Install EMI shield strap with one screw with washer (REF [21300-007297](#)); torque to 6.8 in-lb.
  4. To complete EMI shield installation, follow the steps described in [Installing the Battery Pins/Power PCB Cable \(W10\) \(p. 322\)](#).

### NIBP Connector Replacement

NIBP connector replacement consists of the following procedures:

- [Removing the NIBP Connector \(p. 293\)](#)
- [Installing the NIBP Connector \(p. 294\)](#)

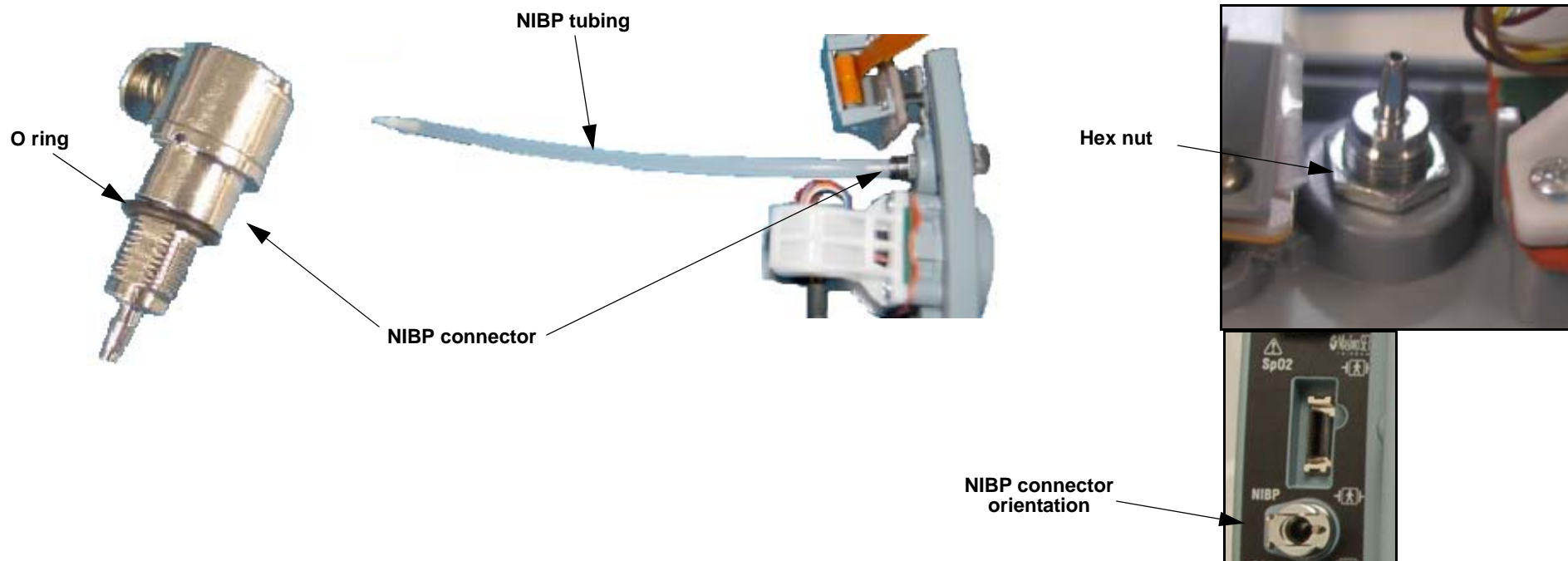

Figure 8.87—NIBP connector and nut location

### Removing the NIBP Connector

Refer to [Figure 8.87 on p. 292](#).

◆ To remove the NIBP connector from the parameter bezel (rear case—refer to [Inside Rear Case Diagrams \(p. 231\)](#)):

**NOTE:** These steps include all parameter bezel options. Your device may not have some of these options.

1. Disassemble the case as described in [Disassembling the Case \(p. 183\)](#).
2. Remove the system/therapy PCB assembly as described in [System \(A01\)/Therapy \(A04\) PCB Assembly Replacement \(p. 234\)](#).
3. Remove the parameter bezel as described in [Removing the Parameter Bezel \(p. 297\)](#).
4. Remove the NIBP tube from the NIBP connector.
5. Remove the fitting nut on the back side of the bezel to remove the connector.
6. Remove the NIBP connector from the bezel.

### Installing the NIBP Connector

Refer to [Figure 8.87 on p. 292](#).

◆ To install the NIBP connector into the parameter bezel (rear case—refer to [Inside Rear Case Diagrams \(p. 231\)](#)):

**NOTE:** When installing a new NIBP connector, use [NIBP Connector Repair Kit \(REF 40577-000009\) \(p. 491\)](#). Ensure the O ring seal is on the NIBP connector.

1. Install the connector (REF [21300-007425](#)) by installing the fitting nut on the back side of the bezel (torque to 10.0 in-lb using a 1/2" deep socket) (see [Figure 9.12 on p. 380](#) for NIBP connector orientation).
2. Connect the NIBP tube (REF [21300-001560](#)) to the NIBP connector (REF [21300-007425](#)).

**NOTE:** If the NIBP tube has been previously disconnected/reconnected from the fitting, the tube end should be trimmed to maintain an airtight seal.

3. Install the parameter bezel as described in [Installing the Parameter Bezel \(p. 299\)](#).
4. Install the system/therapy PCB assembly as described in [Installing the System \(A01\)/Therapy \(A04\) PCB Assembly \(p. 238\)](#).
5. Reassemble the case as described in [Reassembling the Case \(p. 186\)](#).

### Parameter Bezel Replacement

Parameter Bezel replacement consists of the following procedures:

- [Removing the Parameter Bezel \(p. 297\)](#)
- [Installing the Parameter Bezel \(p. 299\)](#)

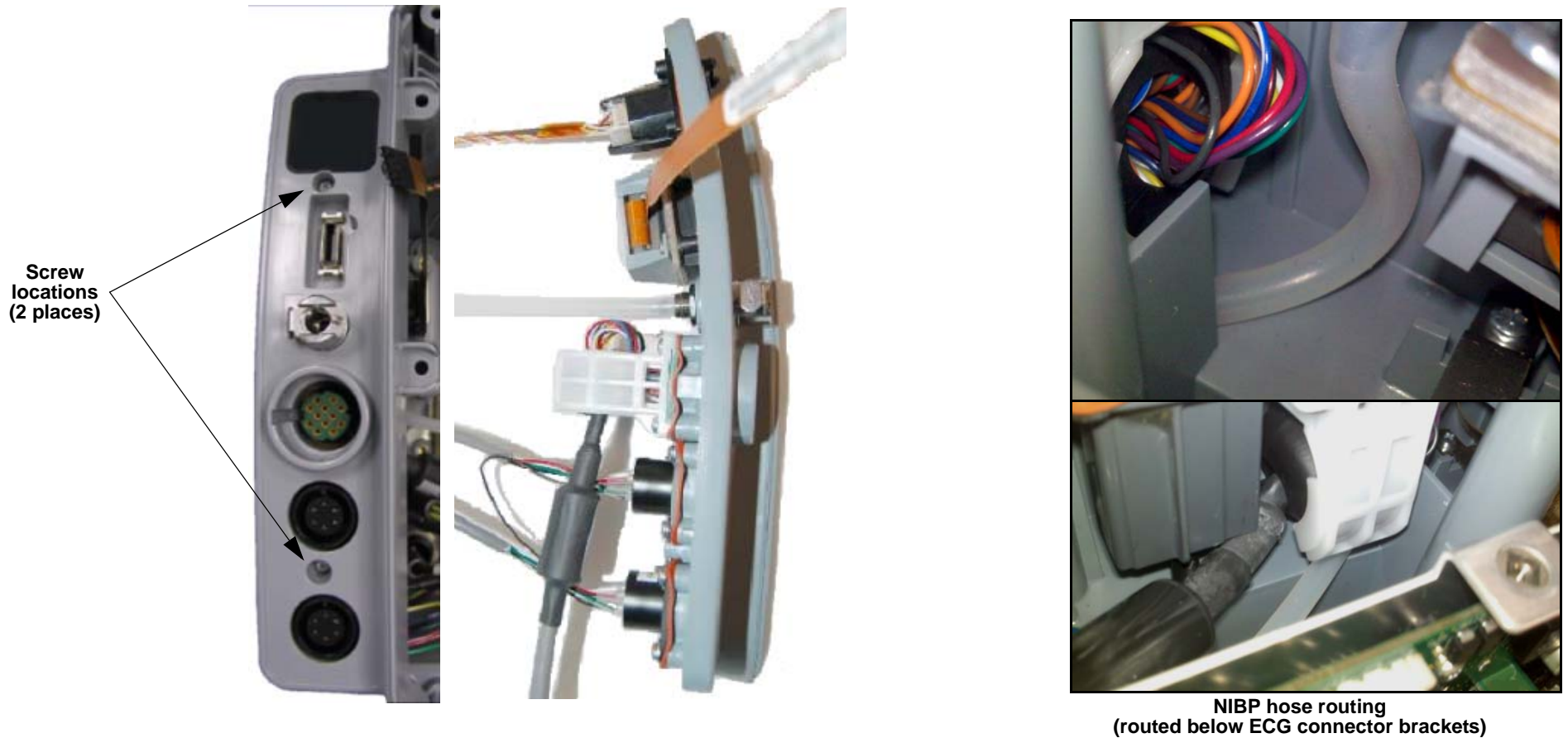

Figure 8.88—Parameter bezel component orientations

### Removing the Parameter Bezel

Refer to [Figure 9.11 on p. 379](#), [Figure 9.12 on p. 380](#), and [Figure 9.13 on p. 381](#).

**NOTE:** This procedure includes the OEM PCB and all options on the parameter bezel. Skip the steps pertaining to options your device does not have.

**NOTE:** To remove cables from the parameter bezel, select the appropriate cable replacement procedure from the [Summary of Replacement Procedures \(p. 173\)](#) (for example, SpO2 Cable).

- ◆ To remove the parameter bezel from the rear case:
  1. Disassemble the case as described in [Disassembling the Case \(p. 183\)](#).
  2. Remove the system/therapy PCB assembly as described in [Removing the System \(A01\)/Therapy \(A04\) PCB Assembly \(p. 235\)](#).
  3. Remove the OEM PCB as described in [Removing the OEM PCB \(A06\) \(p. 262\)](#).
  4. Disconnect the power/contact PCB cable (W05) from the power board at J12 (see [Figure 8.48 on p. 253](#)).
  5. Remove the power/system cable (W01) from the power board at J17.
  6. If present, disconnect the CO2 inlet tube.
  7. If present, carefully disconnect the CO2 cable connector (W28) from CO2 adapter cable (W30).
  8. If present, disconnect the NIBP tube at tube fitting.
  9. If present, carefully disconnect the SpO2 connector flex cable (W22) from J1 of the SpO2 PCB.

### CAUTION

**POSSIBLE COMPONENT DAMAGE** The SpO2 connector flex cable can be damaged during disassembly. If SpO2 connector is damaged, replace the SpO2 flex cable using the [MASIMO SpO2 Panel Mount Cable Repair Kit \(REF 40577-000025\) \(p. 495\)](#)

10. If present, remove the CO2 door.
11. Remove the parameter bezel label from the bezel.
12. Remove the two bezel mounting screws. Discard the screws.
13. Lift out the parameter bezel from the rear case.



### Installing the Parameter Bezel

#### CAUTION

**POSSIBLE MOISTURE LEAKAGE** Visually inspect the mating surfaces between the parameter bezel and the rear case before and after fastening to ensure that they are even.

◆ To install the parameter bezel: *15 steps, (Page 1 of 2)*

**NOTE:** When installing the parameter bezel (REF [21330-001211](#)) as a stand-alone repair, use the [External Hardware Repair Kit \(REF 40577-000004\)](#) (p. 488).

Observe the following:

- Clean away any adhesive residue on the parameter bezel with isopropyl alcohol.
  1. If you are installing a new parameter bezel, transfer the following items from the old parameter bezel to the new parameter bezel, as they apply to your device.
    - ~ ECG connector cable (use a new seal)—[ECG Connector Cable \(W07\) Replacement](#) (p. 314)
    - ~ SpO2 connector cable—[SpO2 Connector Cable \(W22\) Replacement](#) (p. 329)
    - ~ NIBP connector O-ring nut—[NIBP Connector Replacement](#) (p. 292)
    - ~ CO2 inlet connector cable (use a new seal)—[CO2 Inlet Connector Cable \(W28\) Replacement](#) (p. 336)
    - ~ Invasive Pressure connector (use new seals)—[Invasive Pressure Connector Assembly \(W33\) Replacement](#) (p. 341)
    - ~ Temperature connector cable—[Temperature Cable Assembly \(W35\) Replacement](#) (p. 343)
  2. Place the parameter bezel above the rear case to make the cable connections.

◆ To install the parameter bezel: *(Continued) 15 steps, (Page 2 of 2)*

3. If present, route NIBP tube (REF [21300-001560](#)) through opening in power PCB bracket next to the J9 connector, power PCB.  
Connect the NIBP tube to the NIBP connector fitting (REF [21300-007425](#)) and ensure that it is fully seated.
4. If present, connect the SpO2 connector cable (W22) to SpO2 PCB (A16) at JP1.
5. If present, connect the CO2 inlet tube (W28) to the barbed fitting connected to the CO2 module (A23).
6. If present, connect the CO2 connector cable end (W28) to the CO2 adapter cable (W30).
7. Reinstall the parameter bezel onto rear case with two new screws (REF [21300-006965](#)); torque to 6.8 in-lb.

**NOTE: Ensure the NIBP hose isn't pinched by the ECG Brackets or rear case standoff. NIBP hose movement should be unrestricted in bezel cavity** (see [Figure 8.88 on p. 296](#)).

8. Devices without CO2: Place a label spacer (REF [21300-007362](#)) into the CO2 recess in the bezel before applying the label.
9. Connect the power/contact PCB cable (W05) to the power PCB (A03) at J12 (see [Figure 8.53 on p. 257](#)).
10. Connect the power/system cable (W01) to the power PCB (A03) at J17 (see [Figure 8.56 on p. 260](#)).
11. Install the OEM PCB as described in [Installing the OEM PCB \(A06\) \(p. 265\)](#).
12. Install the system/therapy PCB assembly as described in [System \(A01\)/Therapy \(A04\) PCB Assembly Replacement \(p. 234\)](#).
13. Reassemble the case as described in [Reassembling the Case \(p. 186\)](#).
14. Use a new parameter bezel label. Apply the parameter bezel label (#1) from the label set (Example, REF [21501-002408](#). See [Table 9.13 on page 408](#)) to the bezel front. Press the label down firmly.
15. If CO2 is present, install the CO2 cover (REF [21300-007362](#)) onto the CO2 adapter.

### Rear Case Replacement

Rear case replacement consists of the following procedures:

- [Removing the Rear Case \(p. 302\)](#)
- [Installing the Rear Case \(p. 304\)](#)

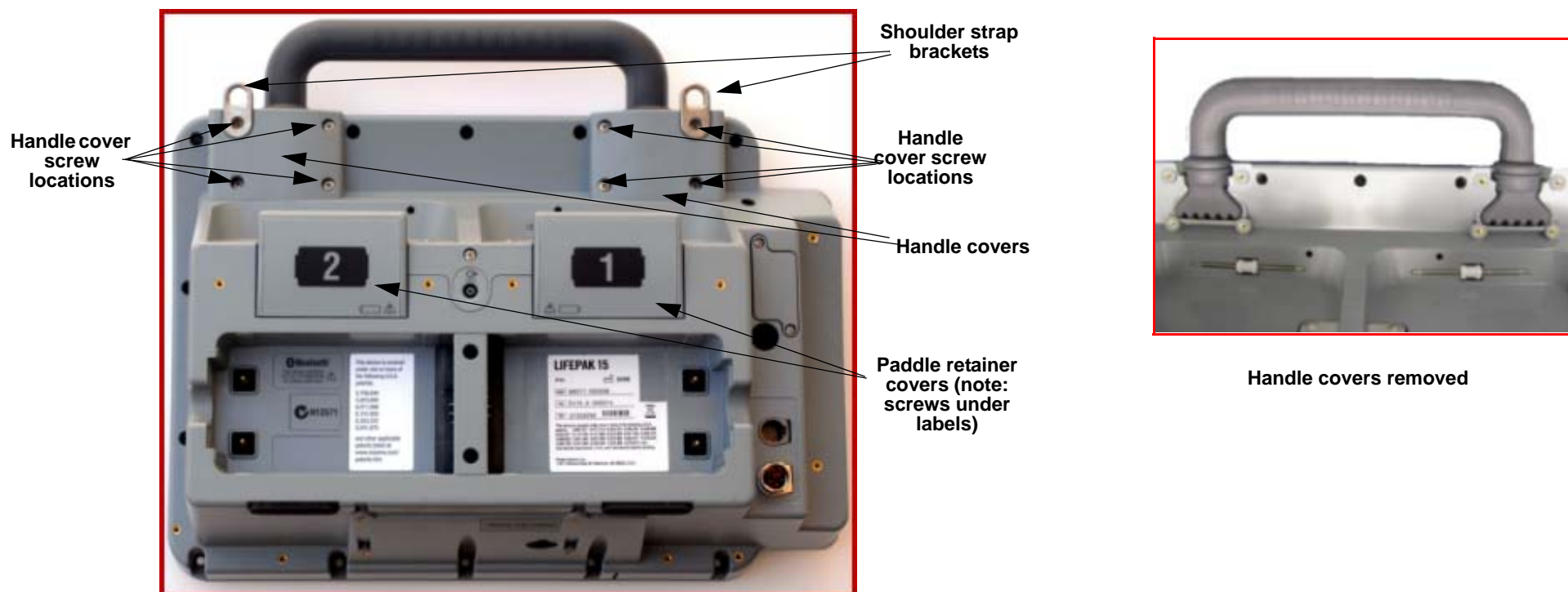

Figure 8.89—Rear case replacement screw locations

### Removing the Rear Case

- ◆ To remove the rear case: *16 steps, (Page 1 of 2)*
  1. Disassemble the case as described in [Disassembling the Case \(p. 183\)](#).
  2. Remove the system/therapy PCB assembly as described in [System \(A01\)/Therapy \(A04\) PCB Assembly Replacement \(p. 234\)](#).
  3. Remove the two mounting screws from the capacitor retaining bracket and remove the bracket (see [Figure 8.63 on p. 268](#)). Discard the screws.
  4. Observing orientation, cut the large tie wrap securing the A15 energy storage capacitor and retaining assembly to the rear case. Remove the energy storage capacitor and retaining assembly as a complete sub-assembly.
  5. Remove the OEM PCB as described in [Removing the OEM PCB \(A06\) \(p. 262\)](#).
  6. Remove the parameter bezel as described in [Removing the Parameter Bezel \(p. 297\)](#).
  7. Remove the NIBP/CO2 module as described in [Removing the NIBP \(A21\)/CO2 \(A23\) Modules \(p. 282\)](#). (Removing the bracket cover in this procedure is not required.)
  8. Remove the SpO2 module as described in [Removing the SpO2 PCB \(A16\) \(p. 272\)](#) (if installed).
  9. Remove the power PCB as described in [Removing the Power PCB \(A03\) \(p. 251\)](#).
  10. Remove the contact PCB as described in [Removing the Contact PCB \(A07\) \(p. 345\)](#).
  11. Remove the system connector cable and auxiliary connector cable as described in [Removing the System Connector Cable \(W08\) or Auxiliary Power Cable \(W09\) \(p. 318\)](#) (use new O-ring seals (REF 21300-000203) during installation).
  12. Disconnect the battery pins/power PCB cable (W10) (REF 21300-007456 or REF 21330-001555) from the rear case by removing the four Kep nuts (see [Figure 8.86 on p. 291](#)). Reuse the Kep nuts.
  13. Remove the CO2 exhaust from the rear case (if installed).

- ◆ To remove the rear case: *(Continued) 16 steps, (Page 2 of 2)*
  14. Remove the USB flex assembly as described in [Removing the W14 - USB Flex Module \(p. 326\)](#)
  15. Remove the drain seal from the rear case.
  16. Remove the handle as described in [Removing the Handle \(p. 307\)](#).

### Installing the Rear Case

- ◆ To install the rear case: *20 steps, (Page 1 of 3)*
- When replacing the Rear Case, use [Rear Case Repair Kit \(REF 40577-000011\)](#) (p. 493).
- Clean adhesive areas with alcohol.

Transfer the following parts from the old rear case to the new rear case:

1. Install handle (REF [21300-007471](#)), handle covers and shoulder straps as described in [Handle Replacement \(p. 307\)](#).  
**NOTE:** If a new handle is required, use [Handle Repair Kit \(REF 40577-000008\)](#) (p. 490).
2. Install the drain seal (REF [21300-001284](#)) into the rear case.
3. Install the CO2 exhaust tubing (REF [21300-001557](#)) onto rear case (if CO2 option).
4. Install the contact PCB as described in [Installing the Contact PCB \(A07\)](#) (p. 345).
5. Install the system connector and auxiliary connector cables as described in [Installing the System Connector Cable \(W08\)](#) or [Auxiliary Power Cable \(W09\)](#) (p. 319) using new O-ring seals (REF [21300-000203](#)).
6. Install the EMI shield (REF [21330-001190](#)) as described in [EMI Shield Replacement \(p. 291\)](#) (new part from repair kit).
7. Install the battery pins/power PCB cable (W10) (REF [21300-007456](#) or REF [21330-001555](#)) as described in [Installing the Battery Pins/Power PCB Cable \(W10\)](#) (p. 322).
8. Install the power to contact PCB cable (W05) (REF [21330-001316](#)) to J42 of the contact PCB.
9. Install the USB flex assembly as described in [USB Flex Module \(W14\) Replacement \(p. 325\)](#).

- ◆ To install the rear case: *(Continued) 20 steps, (Page 2 of 3)*
  10. Install four battery pins as described in [Battery Pin Replacement \(p. 350\)](#) (new part from repair kit).
  11. Secure the energy storage capacitor and retaining assembly as described in [Installing the Energy Storage Capacitor \(A15\) \(p. 270\)](#).
  12. Install the parameter bezel as described in [Installing the Parameter Bezel \(p. 299\)](#).
  13. Install the power PCB as described in [Installing the Power PCB \(A03\) \(p. 255\)](#).
  14. If option is present, install the SpO2 module as described in [Installing the SpO2 PCB \(A16\) \(p. 276\)](#).
  15. Install the NIBP/CO2 Module housing as described in [Installing the NIBP \(A21\)/CO2 \(A23\) Modules \(p. 286\)](#).
  16. Install the OEM PCB as described in [Installing the OEM PCB \(A06\) \(p. 265\)](#).
  17. Install the system/therapy PCB assembly as described in [System \(A01\)/Therapy \(A04\) PCB Assembly Replacement \(p. 234\)](#).
  18. Reassemble the case as described in [Reassembling the Case \(p. 186\)](#).

- ◆ To install the rear case: *(Continued) 20 steps, (Page 3 of 3)*
  19. Install the SpO2 patent label (REF [21501-001993](#)) in battery well 2 (if SpO2 option is present).
  20. When installing the rear case, install the following labels from label set (Example, REF [21501-002408](#). See [Table 9.13 on page 408](#)):
    - ~ Battery well 2 cover label, see label set, label # 9
    - ~ Battery well 1 cover label, see label set, label # 8
    - ~ Bluetooth label, see label set, label # 12
    - ~ Capacitor mount cover label, see label set, label # 2
    - ~ CO2 cover label, see label set, label # 7
    - ~ Sys/Aux connector label, see label set, label # 3
    - ~ FDA label, see label set, label # 5
    - ~ Serial number label (Example, REF [21501-001993](#). See [Table 9.1 on page 361](#)). Special order required, contact Physio-Control technical services.
    - ~ UDI Label (REF [21501-002882](#)). Special order required, contact Physio-Control technical services.



### Handle Replacement

Handle replacement consists of the following procedures:

- [Removing the Handle \(p. 307\)](#)
- [Installing the Handle \(p. 307\)](#)

#### Removing the Handle

- ◆ To remove the handle:
  1. Remove the four screws for each handle cover. Discard the screws.
  2. Remove the left and right shoulder strap brackets.
  3. Remove the left and right handle covers.
  4. Remove the handle.

#### Installing the Handle

- ◆ To install the handle:
  1. Place the handle (REF [21300-007471](#)) in the slots of the case. (Note that the front side of the handle has the triangular indentation.)
  2. Attach the left (REF [21300-007469](#)) and right (REF [21300-007470](#)) handle covers to the rear case using six new screws (REF [21300-000777](#)); torque to 10 in-lb using a P2 bit.
  3. Install the shoulder strap brackets (REF [21300-007472](#)) using two new screws (REF [21300-000777](#)); torque to 10 in-lb using a P2 bit.

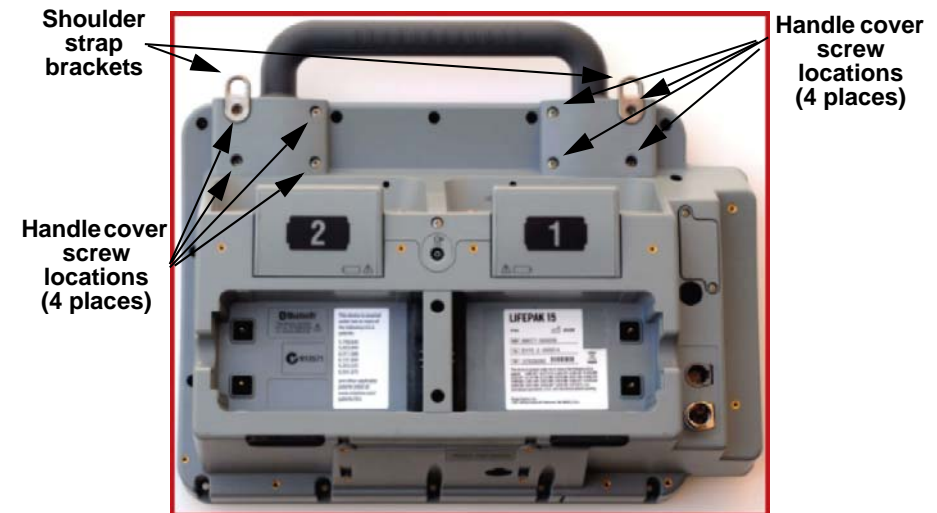

Figure 8.90—Handle replacement

### Paddle Retainer Cover Replacement

Paddle retainer cover replacement consists of the following procedures:

- [Removing the Paddle Retainer Covers \(p. 308\)](#)
- [Installing the Paddle Retainer Covers \(p. 308\)](#)

#### Removing the Paddle Retainer Covers

- ◆ To remove the paddle retainer covers (REF [21330-001241](#)):
  1. Remove the two labels (number 1 and number 2) from the covers.
  2. Remove the six screws (three on each of the left and right covers). Discard the screws.
  3. Remove the left and right retainer covers.

#### Installing the Paddle Retainer Covers

- ◆ To install the paddle retainer covers (REF [21330-001241](#)):

**NOTE:** When installing the paddle retainer covers, use [Paddle Retainer Repair Kit \(REF 40577-000005\) \(p. 489\)](#).

1. Install the left and right retainer covers using six new screws (REF [21300-000777](#)); torque to 10 in-lb using a P2 bit.
2. Apply the new cover labels (#8 and #9) from the label set (for example, REF [21501-002408](#). See [Table 9.13 on page 408](#)).

**NOTE:** Label #8 (displaying the number 1) goes to the right as you view the rear case.

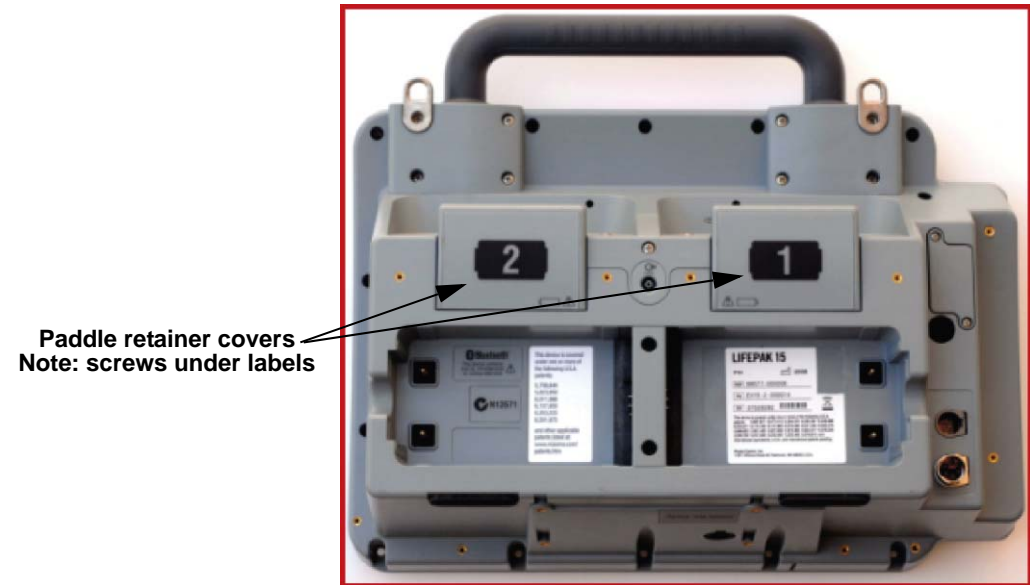

Figure 8.91—Paddle retainer cover locations

### Power/System PCB Cable (W01) Replacement

Power/system PCB cable replacement consists of the following procedures:

- [Removing the Power/System PCB Cable \(W01\) \(p. 309\)](#)
- [Installing the Power/System PCB Cable \(W01\) \(p. 309\)](#)

#### Removing the Power/System PCB Cable (W01)

- ◆ To remove the power/system PCB cable from the rear case (refer to [Inside Rear Case Diagrams \(p. 231\)](#)):
  1. Disassemble the case as described in [Disassembling the Case \(p. 183\)](#).
  2. Remove the system/therapy PCB assembly as described in [System \(A01\)/Therapy \(A04\) PCB Assembly Replacement \(p. 234\)](#).
  3. Remove the OEM shield.  
**NOTE:** For orientation, locate power PCB-J17 on the rear case diagram. (The system PCB J1 end of the power/system PCB cable was disconnected as part of step 2.)
  4. Press the connector locking tabs, and then disconnect the power/system PCB cable from the power PCB (W03) at J17.

#### Installing the Power/System PCB Cable (W01)

- ◆ To install the power/system PCB cable into the rear case (refer to [Inside Rear Case Diagrams \(p. 231\)](#)):
  1. Connect the power/system PCB cable (REF [21300-007456](#)) to the power PCB (A03) at J17 (see [Figure 8.56 on p. 260](#)).
  2. Install the OEM shield (REF [21300-008127](#)).
  3. Install the system/therapy PCB assembly (described in [System \(A01\)/Therapy \(A04\) PCB Assembly Replacement \(p. 234\)](#)).
  4. Reassemble the case as described in [Reassembling the Case \(p. 186\)](#).

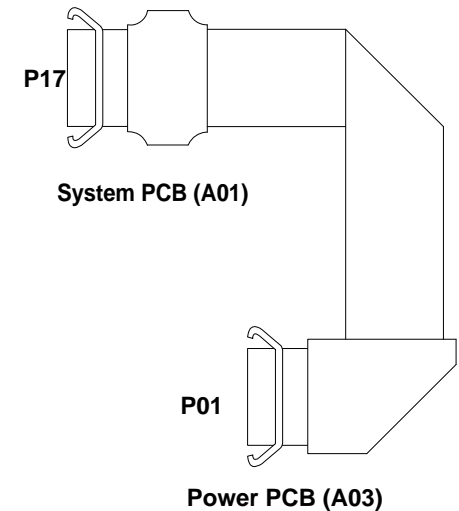

**Figure 8.92—Power/system PCB cable connections**

### Power/Therapy PCB Cable (W02) Replacement

Power/System PCB cable replacement consists of the following procedures:

- [Removing the Power/Therapy PCB Cable \(W02\) \(p. 311\)](#)
- [Installing the Power/Therapy PCB Cable \(W02\) \(p. 311\)](#)

### Removing the Power/Therapy PCB Cable (W02)

- ◆ To remove the power/therapy PCB cable from the rear case:
  1. Disassemble the case as described in [Disassembling the Case \(p. 183\)](#).
  2. Remove the system/therapy PCB assembly as described in [System \(A01\)/Therapy \(A04\) PCB Assembly Replacement \(p. 234\)](#).  
**NOTE:** For orientation, locate power PCB-J8 on the rear case diagram. (The therapy PCB-J20 end of the power/therapy PCB cable was disconnected as part of step 2.)
  3. Press the connector locking tab, and then disconnect the power/therapy PCB cable at J8.

### Installing the Power/Therapy PCB Cable (W02)

- ◆ To install the power/therapy PCB cable into the rear case:
  1. Connect the power/therapy PCB cable (REF [21300-001370](#)) to the power PCB (A03) at J8.
  2. Install the system/therapy PCB assembly as described in [Installing the System \(A01\)/Therapy \(A04\) PCB Assembly \(p. 238\)](#).
  3. Reassemble the case as described in [Reassembling the Case \(p. 186\)](#).

to A04 Therapy PCB

P20



P08

to Power PCB (A03)

Figure 8.93—Power/therapy PCB cable connections

### Power/Contact PCB Cable (W05) Replacement

Power/contact PCB cable replacement consists of the following procedures:

- [Removing the Power/Contact PCB Cable \(W05\)](#) (p. 312)
- [Installing the Power/Contact PCB Cable \(W05\)](#) (p. 313)

#### Removing the Power/Contact PCB Cable (W05)

- ◆ To remove the power/contact PCB cable (REF [21330-001316](#)) from the rear case:
  1. Disassemble the case as described in [Disassembling the Case](#) (p. 183).
  2. Remove the system/therapy PCB assembly as described in [System \(A01\)/Therapy \(A04\) PCB Assembly Replacement](#) (p. 234).
  3. Disconnect the power/contact PCB cable from the power PCB at J12 (may be labeled P12).
  4. Remove the OEM PCB as described in [Removing the OEM PCB \(A06\)](#) (p. 262).
  5. Remove the NIBP/CO2 assembly as described in [Removing the NIBP \(A21\)/CO2 \(A23\) Modules](#) (p. 282).
  6. Disconnect the power/contact PCB cable at J42 of the contact PCB (A07).
  7. Remove the power/contact cable.

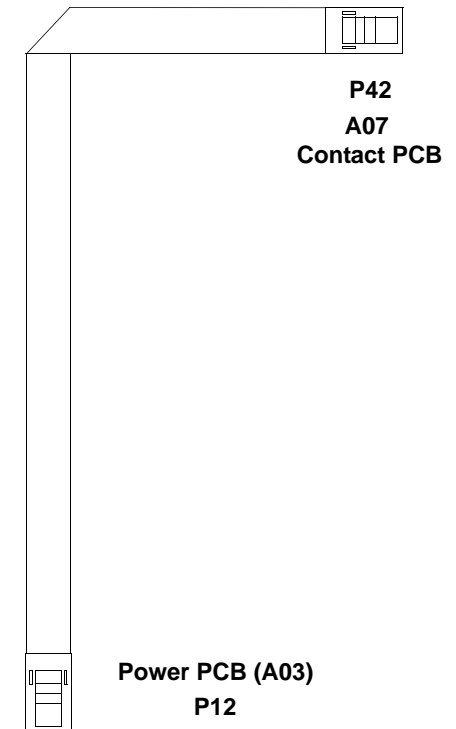

**Figure 8.94— Power/contact PCB cable connections**

### Installing the Power/Contact PCB Cable (W05)

- ◆ To install the power/contact PCB cable:
  1. Connect the power/contact PCB cable (REF [21330-001316](#)) to J42 of contact PCB (A07).
  2. Install the NIBP/CO2 assembly as described in [Installing the NIBP \(A21\)/CO2 \(A23\) Modules \(p. 286\)](#).
  3. Install the OEM PCB as described in [Installing the OEM PCB \(A06\) \(p. 265\)](#).
  4. Connect the power/contact PCB cable to the power PCB (A03) at J12 (may be labeled P12).
  5. Install the system/therapy PCB assembly as described in [Installing the System \(A01\)/Therapy \(A04\) PCB Assembly \(p. 238\)](#).
  6. Reassemble the case as described in [Reassembling the Case \(p. 186\)](#).

### ECG Connector Cable (W07) Replacement

ECG connector cable replacement consists of the following procedures:

- [Removing the ECG Connector Cable \(W07\) \(p. 315\)](#)
- [Installing the ECG Connector Cable \(W07\) \(p. 316\)](#)

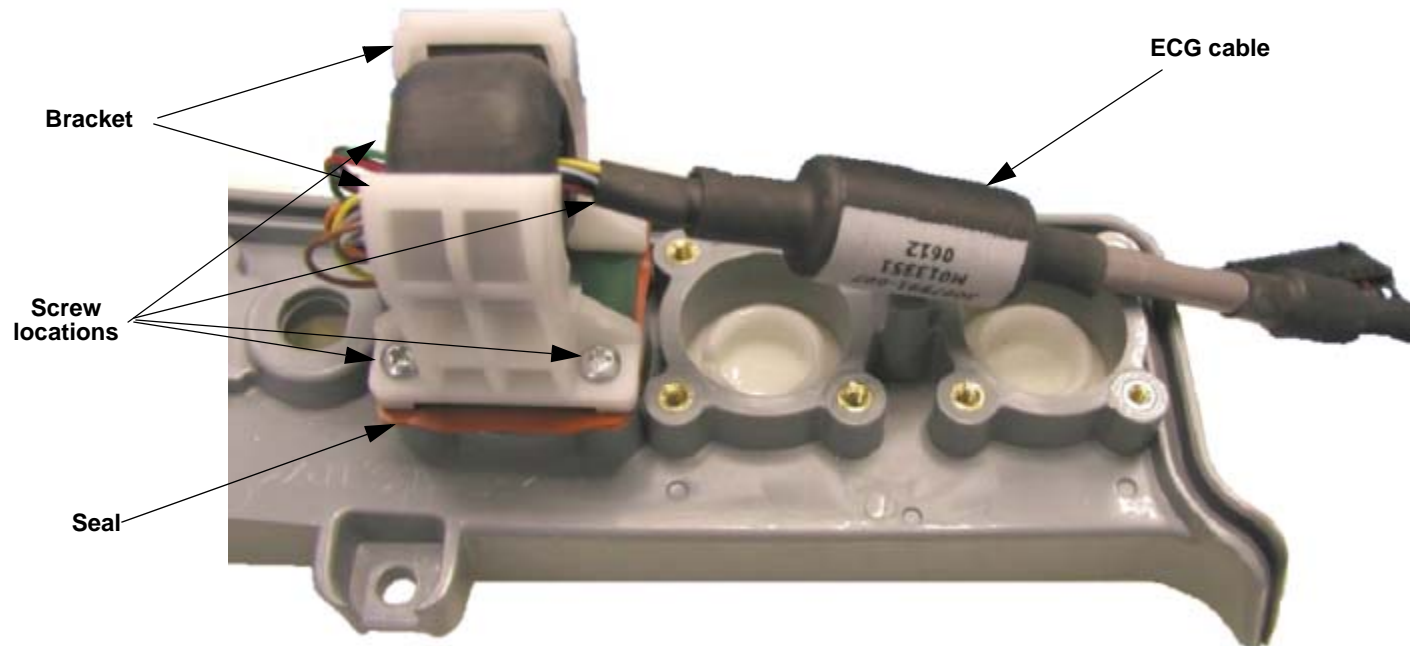

Figure 8.95—ECG cable part and screw locations



### Removing the ECG Connector Cable (W07)

Refer to [Figure 8.95 on p. 314](#).

◆ To remove the ECG connector cable from the rear case (refer to [Inside Rear Case Diagrams \(p. 231\)](#)):

**NOTE:** The ECG connector cable is not available as a separate item. Order the [ECG Connector Repair Kit \(REF 40577-000037\)](#) ([p. 485](#)).

1. Disassemble the case as described in [Disassembling the Case \(p. 183\)](#).
2. Disconnect the ECG cable from the J6 connector on the system PCB (A01).
3. Remove the parameter bezel as described in [Removing the Parameter Bezel \(p. 297\)](#).
4. Remove the four screws securing the support bracket that holds the ECG connector cable. Remove the connector, seal and screws. Discard the seal and screws.

### Installing the ECG Connector Cable (W07)

Refer to [Figure 8.95 on p. 314](#).

◆ To install the ECG connector cable into the rear case (refer to [Inside Rear Case Diagrams \(p. 231\)](#)):

**NOTE:** When installing a new ECG cable, use the [ECG Connector Repair Kit \(REF 40577-000037\) \(p. 485\)](#).

1. Mount the ECG receptacle contact cable on the ECG seal (REF [21300-002683](#)). Orient the ECG receptacle groove to the notch in the seal.
2. Capture the cable ferrite between the two cable support brackets (REF [21300-006304](#)) and line up the ECG receptacle.
3. Secure the ECG connector cable and support brackets to the parameter bezel with the four new screws (REF [21300-006965](#)); torque to 6.8 in-lb.

#### CAUTION

**POSSIBLE MOISTURE LEAKAGE** When installing the ECG connector cable, use a new seal (REF [21300-002683](#)) to help prevent ingress of fluids.

4. Install the parameter bezel as described in [Installing the Parameter Bezel \(p. 299\)](#).
5. Connect the ECG cable to the J6 connector on the system PCB (A01).
6. Reassemble the case as described in [Reassembling the Case \(p. 186\)](#).

### System Connector Cable (W08) and Auxiliary Connector Cable (W09) Replacement

The system connector and auxiliary power cable replacement consists of the following procedures:

- Removing the System Connector Cable (W08) or Auxiliary Power Cable (W09) (p. 318)
- Installing the System Connector Cable (W08) or Auxiliary Power Cable (W09) (p. 319)

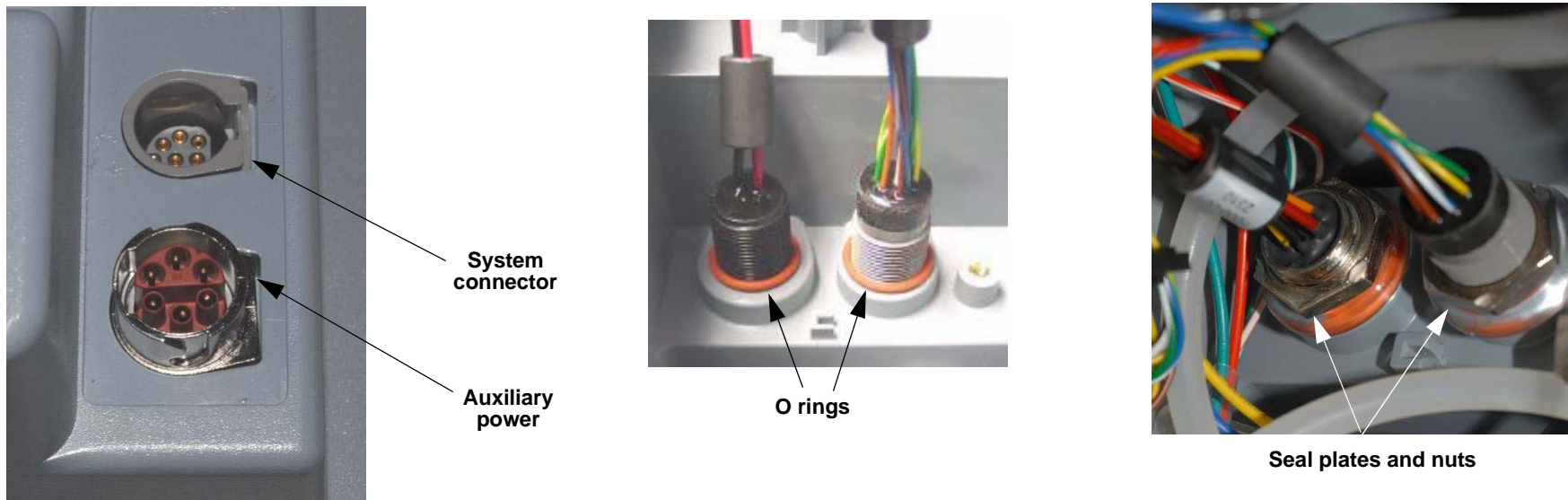

Figure 8.96—System connector cable and auxiliary power cable location and parts

### Removing the System Connector Cable (W08) or Auxiliary Power Cable (W09)

Refer to [Figure 8.96 on p. 317](#).

- ◆ To remove the system connector cable (REF [21330-000156](#)) or auxiliary power cable (REF [21330-001485](#)), from the rear case:
  1. Disassemble the case as described in [Disassembling the Case \(p. 183\)](#).
  2. Remove the parameter bezel as described in [Removing the Parameter Bezel \(p. 297\)](#).
  3. Remove the power PCB as described in [Removing the Power PCB \(A03\) \(p. 251\)](#).
  4. If required, remove the system connector cable nut, connector seal, and O-ring seal. Remove the System connector cable.
  5. If required, remove the auxiliary power cable nut, connector seal, and O-ring seal. Remove the connector.

### Installing the System Connector Cable (W08) or Auxiliary Power Cable (W09)

Refer to [Figure 8.96](#) on p. 317.

◆ To install the system connector cable or auxiliary power cable into the rear case:

**NOTE:** When installing a new power cable (REF [21330-001485](#)), use the [Internal Hardware Repair Kit \(REF 40577-000003\)](#) (p. 488) and [External Hardware Repair Kit \(REF 40577-000004\)](#) (p. 488).

#### CAUTION

**POSSIBLE MOISTURE LEAKAGE** When installing the system connector cable, use a new O-ring seal to help prevent ingress of fluids.

1. If removed, install the system connector cable in hole above the auxiliary power cable connector.
2. Thread the new O-ring (REF [21300-000203](#)) over wire connector of the system cable.
3. Thread seal plate (REF [21300-002650](#)) (flat side down) and nut (REF [21300-002691](#)) over wire connector of the system cable (torque to 10 in-lb using a 3/4" modified deep socket).
4. If removed, install auxiliary power cable in the lower hole provided in rear case.
5. Thread the new O-ring (REF [21300-000203](#)) over wire connector of the auxiliary power cable.
6. Thread seal plate (REF [21300-002650](#)) (flat side down) and nut (REF [21300-002691](#)) over wire connector of the auxiliary power cable (torque to 10 in-lb using a 3/4" modified deep socket).
7. Install the power PCB as described in [Installing the Power PCB \(A03\)](#) (p. 255).
8. Install the parameter bezel as described in [Installing the Parameter Bezel](#) (p. 299).
9. Install the system/therapy PCB assembly as described in [Installing the System \(A01\)/Therapy \(A04\) PCB Assembly](#) (p. 238).
10. Reassemble the case as described in [Reassembling the Case](#) (p. 186).

### Battery Pins / Power PCB Cable (W10) Replacement

- Removing the Battery Pins/Power PCB Cable (W10) (p. 321)
- Installing the Battery Pins/Power PCB Cable (W10) (p. 322)

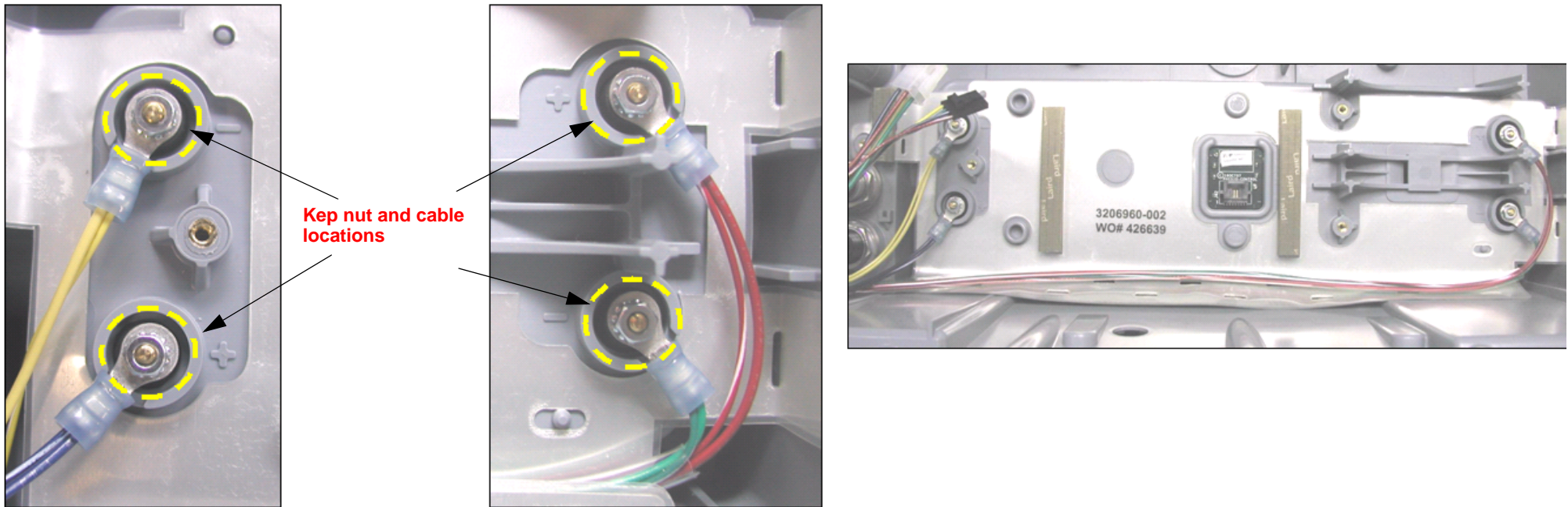

Figure 8.97—Power PCB cable Keep nut and cable locations

### Removing the Battery Pins/Power PCB Cable (W10)

Refer to [Figure 8.97 on p. 320](#) and [Figure 8.86 on p. 291](#).

- ◆ To remove the Battery Pins/Power PCB Cable (W10) from the rear case (see [Figure 9.19 on p. 391](#)):
  1. Disassemble the case as described in [Disassembling the Case \(p. 183\)](#).
  2. Remove the system/therapy board as described in [Removing the System \(A01\)/Therapy \(A04\) PCB Assembly \(p. 235\)](#).
  3. Observing orientation, cut the large tie wrap securing the A15 energy storage capacitor and retaining assembly to the rear case.
  4. Remove the OEM PCB as described in [Removing the OEM PCB \(A06\) \(p. 262\)](#).
  5. Remove the capacitor as described in [Removing the Energy Storage Capacitor \(A15\) \(p. 269\)](#).
  6. Remove the power PCB as described in [Removing the Power PCB \(A03\) \(p. 251\)](#).
  7. Remove the NIBP/CO2 assembly as described in [Removing the NIBP \(A21\)/CO2 \(A23\) Modules \(p. 282\)](#). Removing the bracket cover in this procedure is not required.
  8. Remove the four nuts to disconnect terminals P43 and P44 at battery well 1, and P45 and P46 at battery well 2 (see [Figure 8.86 on p. 291](#)). Note the wire colors and orientation for reinstalling the wires to the same studs. Remove the cable.
  9. If replacing the EMI shield, lift the EMI shield out of the rear case and discard. Clean the rear case of residual adhesive.

### Installing the Battery Pins/Power PCB Cable (W10)

- ◆ To install the W10 cable: 10 steps, (Page 1 of 2)

If required, replace EMI shield as described in [EMI Shield Replacement \(p. 291\)](#).

**NOTE:** (Optional) For REF [21330-001555](#), Install the Power PCB as described in [Installing the Power PCB \(A03\) \(p. 255\)](#) before performing steps 1 and 2 of Installing the Battery Pins/Power PCB Cable (W10) for ease of assembly.

1. Install the battery pins/power PCB (W10) cable (REF [21330-001394](#) or REF [21330-001555](#)).
2. Connect terminals P43 and P44 at Battery Well 1, and P45 and P46 at Battery Well 2 and replace the four Kep nuts (REF [21300-000804](#)) (torque to 4.0 in-lb using 1/4" socket and drive adapter). See [Figure 8.97 on p. 320](#) and [Figure 8.99 on p. 324](#).
3. Install the power PCB as described in [Installing the Power PCB \(A03\) \(p. 255\)](#).
4. If removed and present, install the SpO2 PCB as described in [Installing the SpO2 PCB \(A16\) \(p. 276\)](#).
5. For battery pins/power PCB (W10) cable (REF [21330-001394](#)): connect the battery pins/power PCB cable (W10) connector locking tabs to the power PCB at J11. For REF [21330-001555](#), battery pins/power PCB cable is mounted to the power PCB.
6. Install the NIBP/CO2 Module as described in [Installing the NIBP \(A21\)/CO2 \(A23\) Modules \(p. 286\)](#).
7. Install the OEM PCB as described in [Installing the OEM PCB \(A06\) \(p. 265\)](#).
8. Install the energy storage capacitor as described in [Installing the Energy Storage Capacitor \(A15\) \(p. 270\)](#).

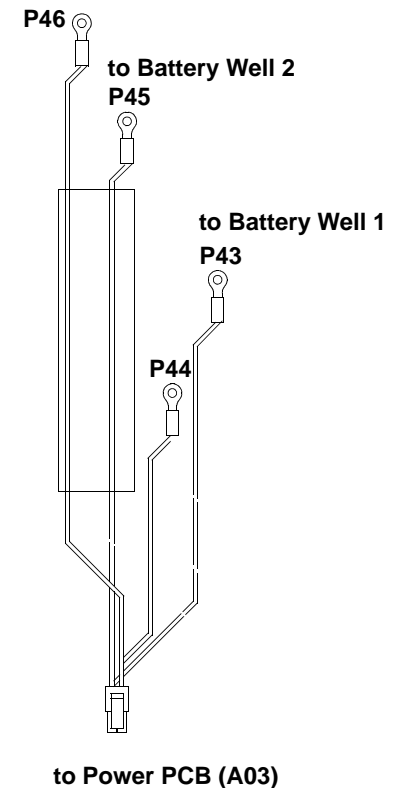

Figure 8.98— V2/V4 cable (REF [21330-001394](#)) only P11 is used.



- ◆ To install the W10 cable: *(Continued) 10 steps, (Page 2 of 2)*
  9. Install the system/memory/therapy PCB assembly as described in [Installing the System \(A01\)/Therapy \(A04\) PCB Assembly \(p. 238\)](#).
  10. Reassemble the case as described in [Reassembling the Case \(p. 186\)](#).

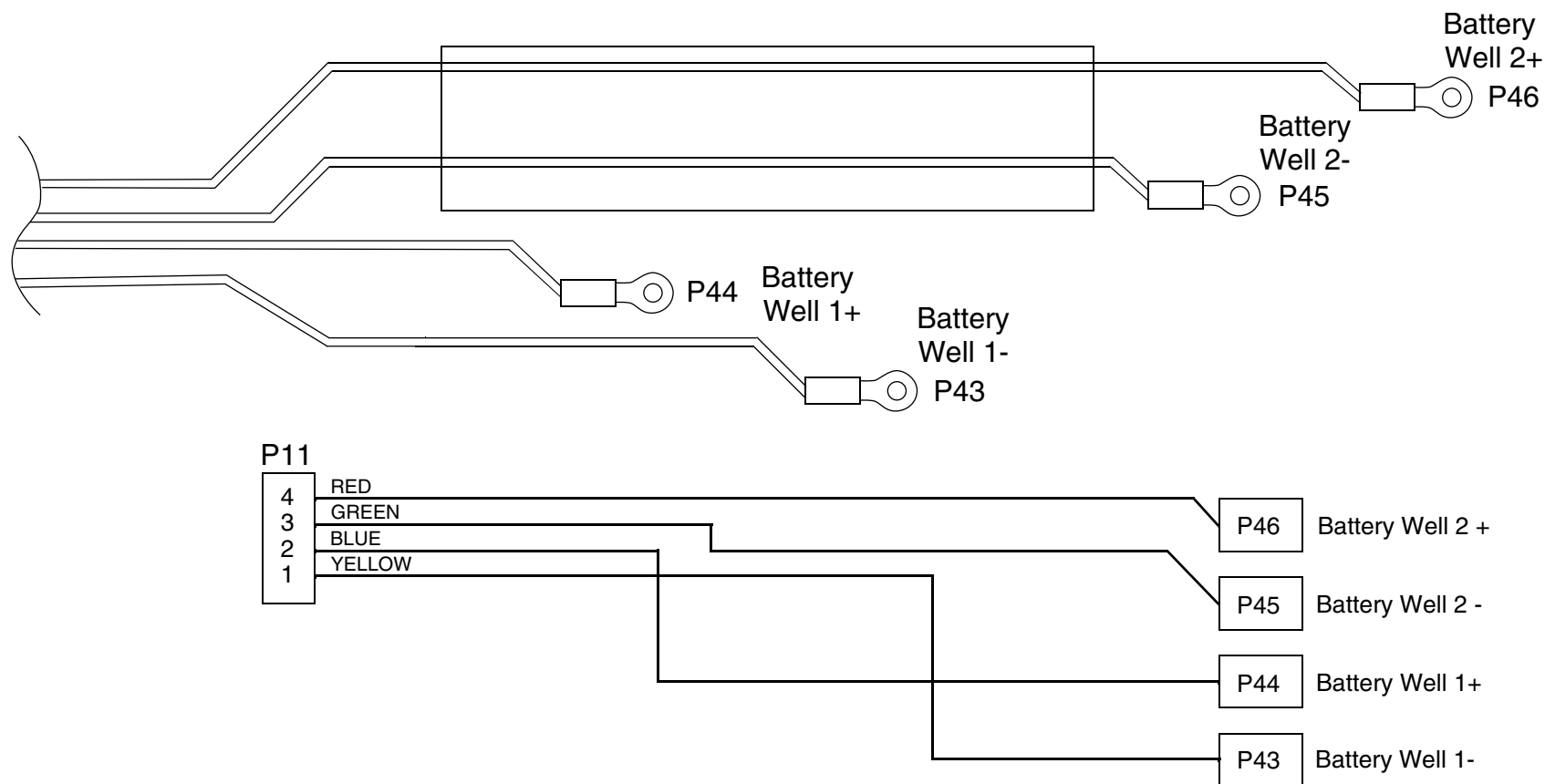

Figure 8.99—V2 (REF [21330-001555](#))

### USB Flex Module (W14) Replacement

USB flex module replacement consists of the following procedures:

- [Removing the W14 - USB Flex Module \(p. 326\)](#)
- [Installing the W14 - USB Flex Module \(p. 326\)](#)

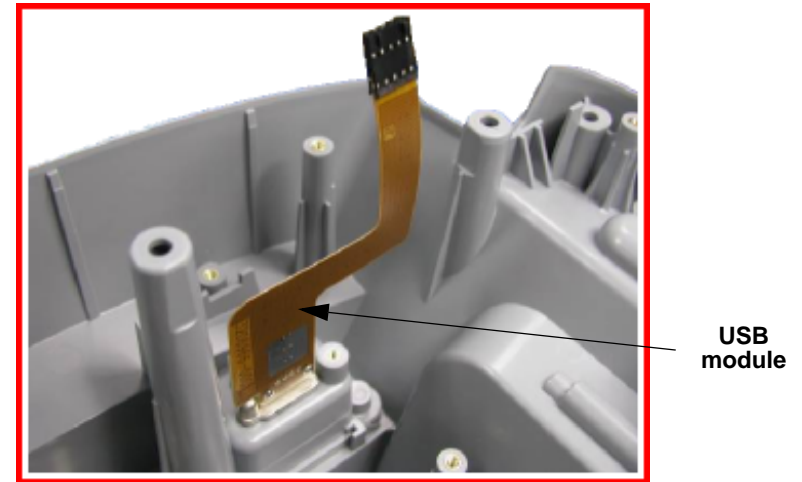

Figure 8.100—USB flex module

### Removing the W14 - USB Flex Module

- ◆ To remove the USB flex module (W14) (REF [21330-001534](#)):
  1. Disassemble the case as described in [Disassembling the Case \(p. 183\)](#).
  2. Remove the system/therapy board as described in [Removing the System \(A01\)/Therapy \(A04\) PCB Assembly \(p. 235\)](#).
  3. Remove the parameter bezel as described in [Removing the Parameter Bezel \(p. 297\)](#).
  4. From inside the rear case, remove the screw holding the spring clip. Remove the spring clip. Discard the screw.
  5. From the outside rear of the case, loosen the two retained screws and remove the USB access door.
  6. Remove the two USB connector mounting screws. Discard the screws.
  7. Remove the USB flex assembly.

### Installing the W14 - USB Flex Module

To install the USB flex module (W14) (REF [21330-001534](#)):

1. From inside of the rear case, place the USB flex module into slot in the rear case.
2. Install the spring clip (REF [21300-001575](#)) using one new screw (REF [21300-001038](#)); torque to 6.8 in-lb.
3. From the outside of the rear case, install two screws (REF [21300-001038](#)) into the USB flex module; torque to 6.8 in-lb.
4. Install the USB access door (REF [21330-001169](#)) by tightening the two retained screws; torque to 6.8 in-lb.
5. Install the parameter bezel as described in [Installing the Parameter Bezel \(p. 299\)](#).
6. Install the system/therapy PCB assembly as described in [Installing the System \(A01\)/Therapy \(A04\) PCB Assembly \(p. 238\)](#).
7. Reassemble the case as described in [Reassembling the Case \(p. 186\)](#).

### OEM PCB/SpO2 (W21) Module Cable Replacement

OEM PCB/SpO2 Module cable replacement consists of the following procedures:

- [Removing the OEM PCB/SpO2 Module Cable \(W21\) \(p. 328\)](#)
- [Installing the OEM PCB/SpO2 Module Cable \(W21\) \(p. 328\)](#)

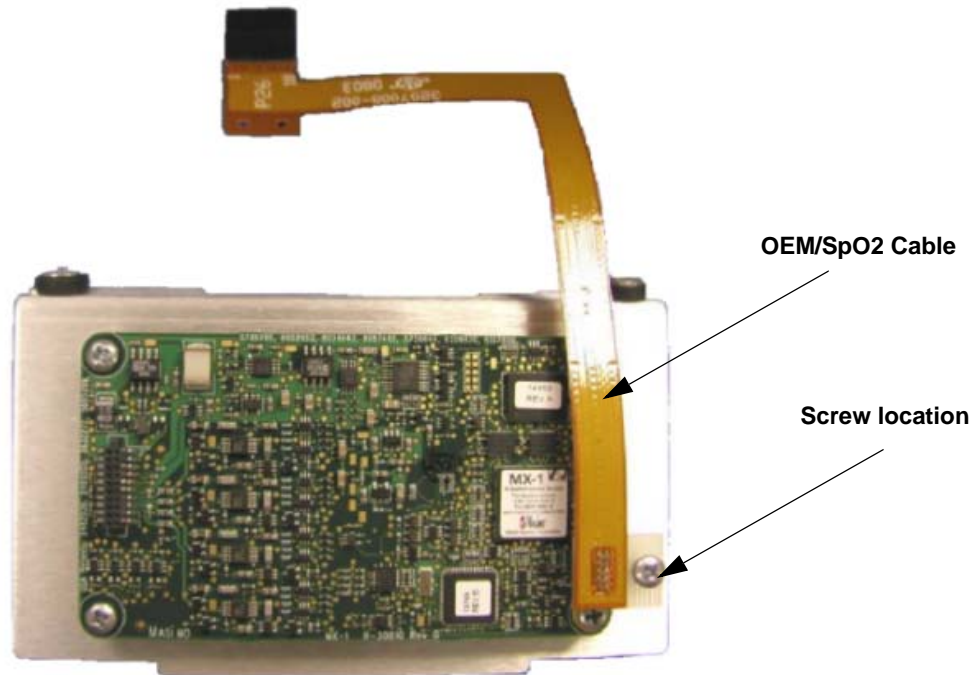

Figure 8.101—OEM/SpO2 cable screw location

### Removing the OEM PCB/SpO2 Module Cable (W21)

- ◆ To remove the OEM PCB/SpO2 cable (REF [21330-001524](#)) from the rear case:
  1. Disassemble the case as described in [Disassembling the Case \(p. 183\)](#).
  2. Remove the system/therapy PCB assembly as described in [System \(A01\)/Therapy \(A04\) PCB Assembly Replacement \(p. 234\)](#).
  3. Remove the SpO2 module (A26) as described in [Removing the SpO2 PCB \(A16\) \(p. 272\)](#). Do not remove SpO2 connector flex cable (W22) as described in step 8 of that procedure.
  4. Lift SpO2 assembly from rear enough to gain access to screw. Remove and discard the screw holding the W21 cable to the J3 connector.
  5. Disconnect the OEM PCB/SpO2 cable from the SpO2 module (A16) at J3. The SpO2 module will still be connected to the system by the SpO2 connector flex cable.

### Installing the OEM PCB/SpO2 Module Cable (W21)

- ◆ To install the OEM PCB/SpO2 cable (REF [21330-001524](#)):
  1. Connect the OEM PCB/SpO2 cable to the SpO2 Module (A16) at J3.
  2. Install one new screw (REF [21300-006251](#)) on the SpO2 module holding the W21 cable to the J3 connector; torque to 4.0 in-lb.
  3. Install the SpO2 module (A16) as described in [Installing the SpO2 PCB \(A16\) \(p. 276\)](#).
  4. Install the system/therapy PCB assembly as described in [System \(A01\)/Therapy \(A04\) PCB Assembly Replacement \(p. 234\)](#).
  5. Reassemble the case as described in [Reassembling the Case \(p. 186\)](#).

### SpO2 Connector Cable (W22) Replacement

SpO2 connector cable replacement consists of the following procedures:

- [Removing the SpO2 Connector Cable \(W22\) \(p. 330\)](#)
- [Installing the SpO2 Connector Cable \(W22\) \(p. 330\)](#)



SpO2 connector  
orientation

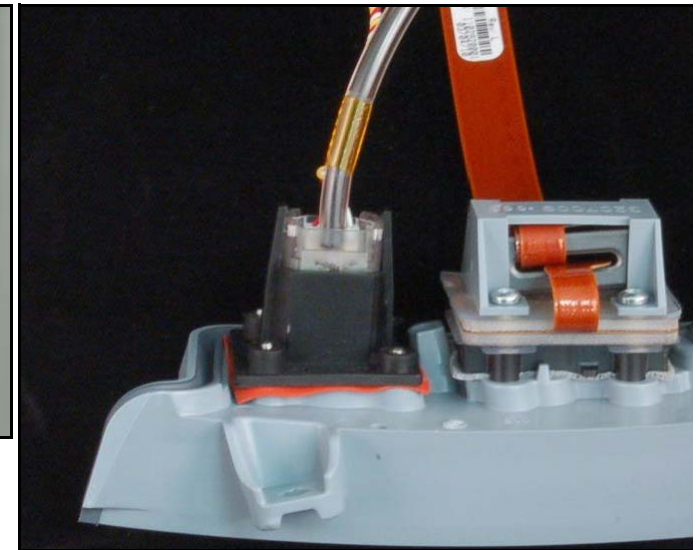

Figure 8.102—SpO2 connector cable

### Removing the SpO2 Connector Cable (W22)

- ◆ To remove the SpO2 connector cable (REF [21330-001290](#)) from the rear case (refer to [Inside Rear Case Diagrams \(p. 231\)](#) and [Figure 9.21 on p. 398](#)):
  1. Disassemble the case as described in [Disassembling the Case \(p. 183\)](#).
  2. Remove the system/therapy PCB assembly as described in [System \(A01\)/Therapy \(A04\) PCB Assembly Replacement \(p. 234\)](#).
  3. Remove the parameter bezel as described in [Removing the Parameter Bezel \(p. 297\)](#).
  4. Remove the four screws (using a Torx T-10 bit) securing the ferrite housing and SpO2 connector cable. Discard the screws.
  5. Remove the connector from the parameter bezel.

### Installing the SpO2 Connector Cable (W22)

- ◆ To install the SpO2 connector cable (REF [21330-001290](#)) into the rear case (refer to [Inside Rear Case Diagrams \(p. 231\)](#)):

**NOTE:** When replacing the SpO2 cable use [MASIMO SpO2 Panel Mount Cable Repair Kit \(REF 40577-000025\) \(p. 495\)](#).

1. Fold SpO2 connector cable (W22) over the top of the ferrite bead and then position the ferrite bead behind the connector.
2. Install the ferrite housing (REF [21300-007112](#)) over the flex cable and ferrite bead.
3. Insert the SpO2 connector cable into the parameter bezel and secure with the four new screws (REF [21300-007557](#)); torque to 2 in-lb using a Torx T-10 bit (see [Figure 8.102 on p. 329](#) for connector orientation).
4. Install the parameter bezel as described in [Installing the Parameter Bezel \(p. 299\)](#).
5. Install the system/therapy PCB assembly as described in [Installing the System \(A01\)/Therapy \(A04\) PCB Assembly \(p. 238\)](#).
6. Reassemble the case as described in [Reassembling the Case \(p. 186\)](#).



### Therapy to Cap Discharge PCB Wire Harness (W24) Replacement

Therapy capacitor wire harness replacement consists of the following procedures:

#### Removing the Therapy Capacitor Wire Harness (W24)

See steps documenting cable removal in [Separating the Therapy PCB \(A04\)](#) (p. 245).

#### Installing the Therapy Capacitor Wire Harness (W24)

See steps documenting cable installation in [Replacing the Therapy PCB \(A04\)](#) (p. 247).

### OEM PCB/CO2 Module Cable (W26) Replacement

OEM PCB/CO2 Module cable replacement consists of the following procedures:

- [Removing the OEM PCB/CO2 Module Cable \(W26\) \(p. 333\)](#)
- [Installing the OEM PCB/CO2 Module Cable \(W26\) \(p. 333\)](#)

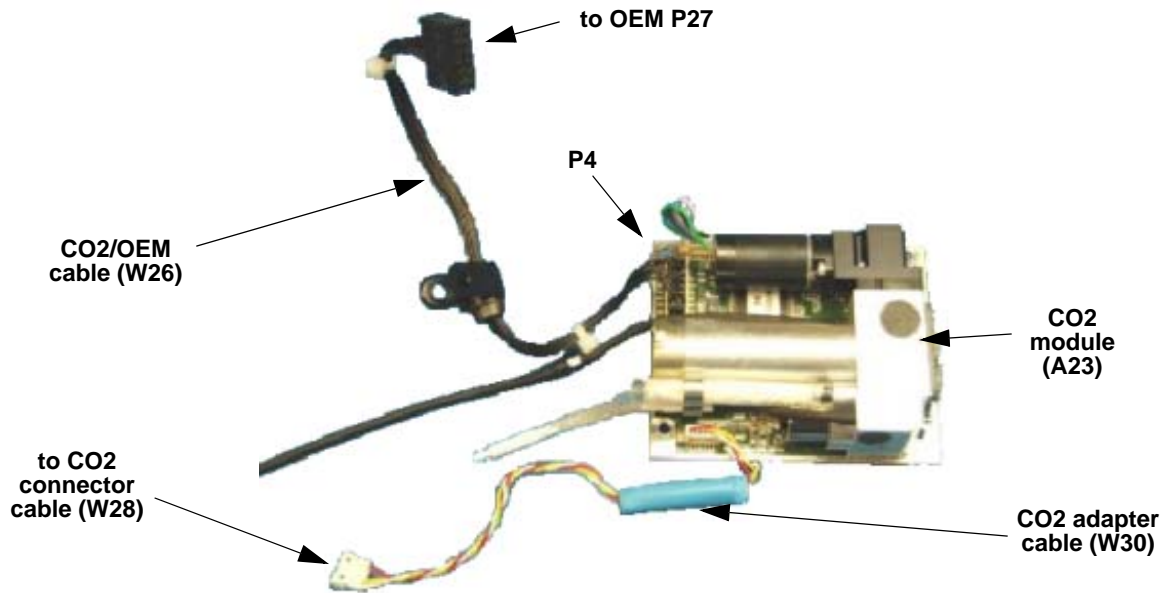

Figure 8.103—CO2 module cable

### Removing the OEM PCB/CO2 Module Cable (W26)

Refer to [Figure 8.103 on p. 332](#).

- ◆ To remove the OEM PCB/CO2 module cable (REF [21330-001217](#)) from the rear case:
  1. Disassemble the case as described in [Disassembling the Case \(p. 183\)](#).
  2. Remove the system/therapy PCB assembly as described in [System \(A01\)/Therapy \(A04\) PCB Assembly Replacement \(p. 234\)](#).
  3. Remove the OEM PCB (A06) as described in [Removing the OEM PCB \(A06\) \(p. 262\)](#). (This step disconnects the W26 cable from the OEM PCB.)
  4. Remove the NIBP/CO2 module as described in [Removing the NIBP \(A21\)/CO2 \(A23\) Modules \(p. 282\)](#).
  5. Disconnect the OEM PCB/CO2 module cable from the CO2 PCB (A23) at J4.
  6. Disconnect the OEM/CO2 module cable from the microwire saddle clip.

### Installing the OEM PCB/CO2 Module Cable (W26)

Refer to [Figure 8.103 on p. 332](#).

- ◆ To install the OEM PCB/CO2 module cable (REF [21330-001217](#)) into the rear case:
  1. Connect the OEM PCB/CO2 module cable to the A23 CO2 PCB at J4.
  2. Install the NIBP/CO2 Module as described in [Installing the NIBP \(A21\)/CO2 \(A23\) Modules](#).
  3. Route the OEM/CO2 module cable through the microwire saddle clip (if not already completed).
  4. Install the OEM PCB (A06) as described in [Installing the OEM PCB \(A06\)](#).
  5. Install the system/therapy PCB assembly as described in [Installing the System \(A01\)/Therapy \(A04\) PCB Assembly](#).
  6. Reassemble the case as described in [Reassembling the Case \(p. 186\)](#).

### OEM PCB/NIBP Module Cable (W27) Replacement

OEM PCB/NIBP Module cable replacement consists of the following procedures:

- [Removing the OEM PCB/NIBP Module Cable \(W27\) \(p. 335\)](#)
- [Installing the OEM PCB/NIBP Module Cable \(W27\) \(p. 335\)](#)

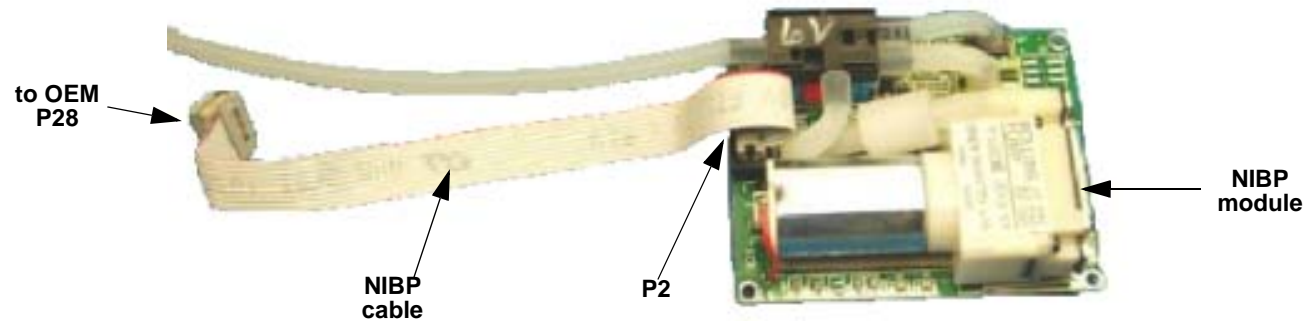

Figure 8.104—NIBP module cable

### Removing the OEM PCB/NIBP Module Cable (W27)

Refer to [Figure 8.104 on p. 334](#).

- ◆ To remove the OEM PCB/NIBP module cable (REF [21330-000235](#)) from the rear case:
  1. Disassemble the case as described in [Disassembling the Case \(p. 183\)](#).
  2. Remove the system/therapy PCB assembly as described in [System \(A01\)/Therapy \(A04\) PCB Assembly Replacement \(p. 234\)](#).
  3. Remove the OEM PCB (A06) as described in [Removing the OEM PCB \(A06\) \(p. 262\)](#). (This step disconnects the W27 cable from the OEM PCB.)
  4. Remove the NIBP/CO2 module as described in [Removing the NIBP \(A21\)/CO2 \(A23\) Modules \(p. 282\)](#).
  5. Disconnect the OEM PCB/NIBP module cable (W27) from the A21 NIBP PCB at J2.

### Installing the OEM PCB/NIBP Module Cable (W27)

Refer to [Figure 8.104 on p. 334](#).

- ◆ To install the OEM PCB/NIBP module cable (REF [21330-000235](#)):
  1. Connect the OEM PCB/NIBP module cable to the A21 NIBP PCB at J2.
  2. Install the NIBP/CO2 module as described in [Installing the NIBP \(A21\)/CO2 \(A23\) Modules \(p. 286\)](#).
  3. Install the OEM PCB (A06) as described in [Installing the OEM PCB \(A06\) \(p. 265\)](#).
  4. Install the system/therapy PCB assembly as described in [Installing the System \(A01\)/Therapy \(A04\) PCB Assembly \(p. 238\)](#).
  5. Reassemble the case as described in [Reassembling the Case \(p. 186\)](#).

### CO2 Inlet Connector Cable (W28) Replacement

CO2 inlet connector cable replacement consists of the following procedures:

- [Removing the CO2 Inlet Connector Cable \(W28\) \(p. 337\)](#)
- [Installing the CO2 Inlet Connector Cable \(W28\) \(p. 338\)](#)

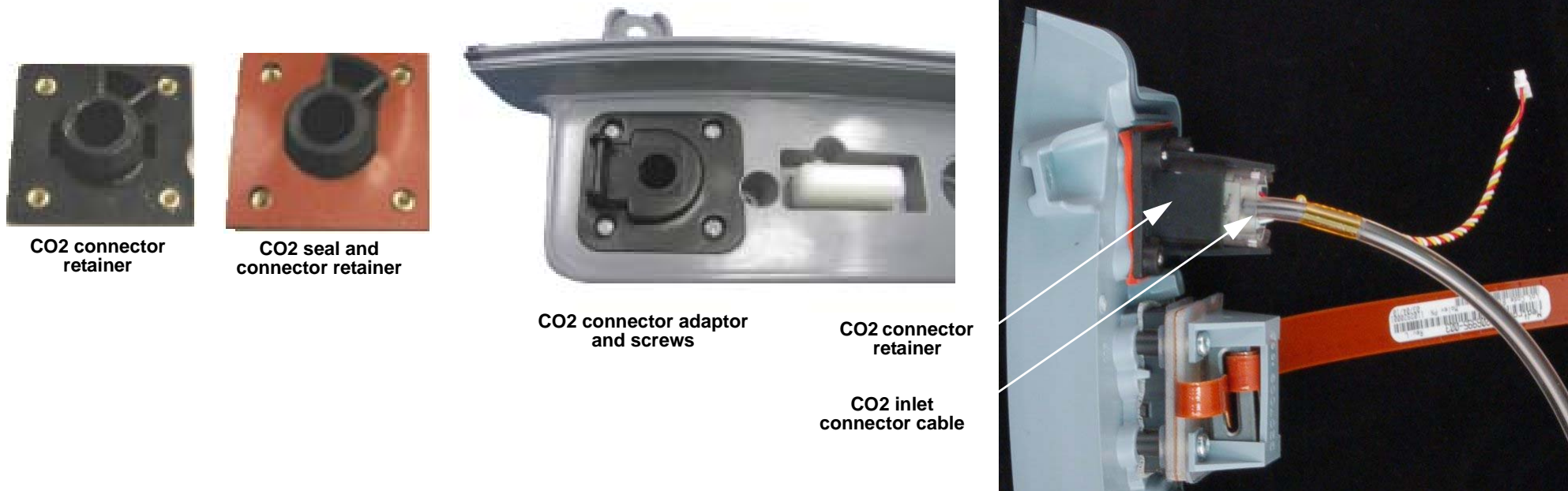

Figure 8.105—CO2 connector parts

### Removing the CO2 Inlet Connector Cable (W28)

- ◆ To remove the CO2 inlet connector cable (REF [21330-001529](#)) from the parameter bezel (rear case—refer to [Inside Rear Case Diagrams \(p. 231\)](#) and [Figure 9.21 on p. 398](#)):
  1. Disassemble the case as described in [Disassembling the Case \(p. 183\)](#).
  2. Remove the system/therapy PCB assembly as described in [Removing the System \(A01\)/Therapy \(A04\) PCB Assembly \(p. 235\)](#).
  3. Remove the parameter bezel as described in [Removing the Parameter Bezel \(p. 297\)](#).
  4. Disengage the CO2 inlet connector cable from the CO2 connector retainer by spreading the arms of the retainer and sliding out the CO2 inlet connector body (see [Figure 8.105 on p. 336](#)). Discard the connector retainer clip.
  5. Remove the four screws securing the CO2 connector adapter to the parameter bezel.
  6. Remove the CO2 connector adapter and, from the underside of the bezel, remove the CO2 connector retainer and seal. Discard the seal and screws.

### Installing the CO2 Inlet Connector Cable (W28)

◆ To install the CO2 inlet connector cable:

**NOTE:** When replacing the CO2 inlet connector cable assembly, use [CO2 Connector Repair Kit \(REF 40577-000038\)](#) (p. 487).

1. Set the CO2 connector adapter (REF [21300-001548](#)) in place on the face of the new bezel.
2. Place the new CO2 connector retainer (REF [21300-007998](#)) and new seal (REF [21300-001314](#)) in place on the underside of the bezel and tighten together with four new screws (REF [21300-007353](#)); torque to 2.0 in-lb using a P0 bit.
3. Slide the CO2 inlet connector cable (W28) (REF [21330-001529](#)) into the new CO2 connector retainer.

#### CAUTION

**POSSIBLE MOISTURE LEAKAGE** When installing the W28 cable, apply 2 in-lb of torque when installing the screw retaining the W28 cable to help prevent ingress of fluids.

4. Install the parameter bezel as described in [Installing the Parameter Bezel](#) (p. 299).
5. Install the system/therapy PCB assembly as described in [Installing the System \(A01\)/Therapy \(A04\) PCB Assembly](#) (p. 238).
6. Reassemble the case as described in [Reassembling the Case](#) (p. 186).



### CO2 Adapter Cable (W30) Replacement

CO2 Adapter cable replacement consists of the following procedures:

- [Removing the CO2 Adapter Cable \(W30\) \(p. 340\)](#)
- [Installing the CO2 Adapter Cable \(W30\) \(p. 340\)](#)

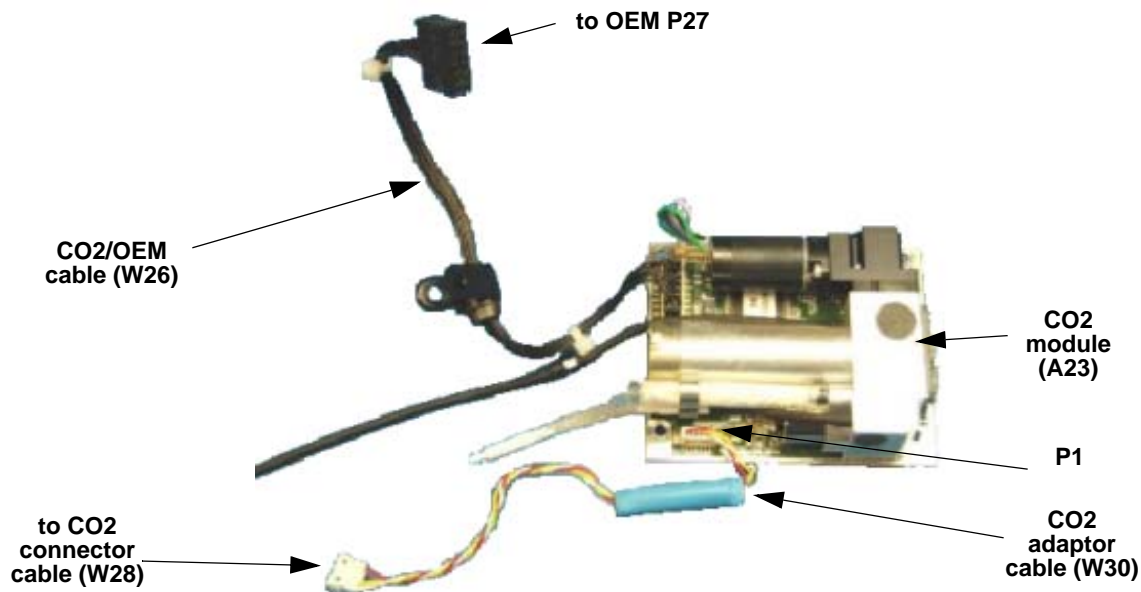

Figure 8.106—CO2 module and cables

### Removing the CO2 Adapter Cable (W30)

Refer to [Figure 8.106 on p. 339](#).

- ◆ To remove the CO2 adapter cable (REF [21330-000237](#)) from the rear case:
  1. Disassemble the case as described in [Disassembling the Case \(p. 183\)](#).
  2. Remove the system/therapy PCB assembly as described in [Removing the System \(A01\)/Therapy \(A04\) PCB Assembly \(p. 235\)](#).
  3. Remove the OEM PCB (A06) as described in [Removing the OEM PCB \(A06\) \(p. 262\)](#).
  4. Remove the NIBP/CO2 module as described in [Removing the NIBP \(A21\)/CO2 \(A23\) Modules \(p. 282\)](#).
  5. Disconnect the CO2 adapter cable from the CO2 PCB (A23) at J1.

### Installing the CO2 Adapter Cable (W30)

Refer to [Figure 8.106 on p. 339](#).

- ◆ To install the CO2 adapter cable (REF [21330-000237](#)) from the rear case:
  1. Connect the CO2 adapter cable to the A23 CO2 PCB at J1.
  2. Install the NIBP/CO2 Module as described in [Installing the NIBP \(A21\)/CO2 \(A23\) Modules \(p. 286\)](#).
  3. Install the OEM PCB (A06) as described in [Installing the OEM PCB \(A06\) \(p. 265\)](#).
  4. Install the system/therapy PCB assembly as described in [Installing the System \(A01\)/Therapy \(A04\) PCB Assembly \(p. 238\)](#).
  5. Reassemble the case as described in [Reassembling the Case \(p. 186\)](#).

### Invasive Pressure Connector Assembly (W33) Replacement

Invasive pressure connector assembly replacement consists of the following procedures:

- [Removing the Invasive Pressure Connector Assembly \(W33\) \(p. 342\)](#)
- [Installing the Invasive Pressure Connector Assembly \(W33\) \(p. 342\)](#)

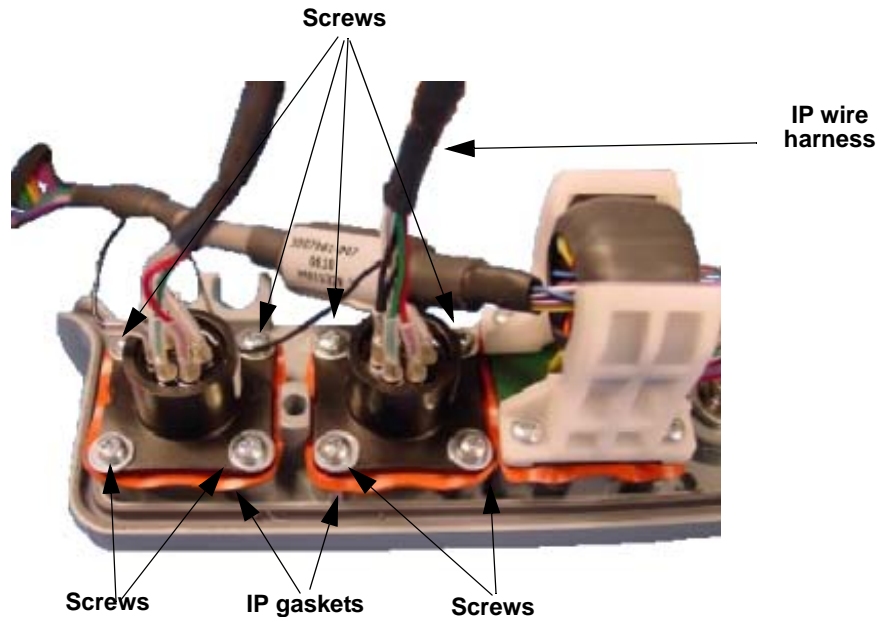

Figure 8.107—Invasive pressure parts and screw locations

### Removing the Invasive Pressure Connector Assembly (W33)

- ◆ To remove the invasive pressure connector assembly from the rear case (refer to [Inside Rear Case Diagrams \(p. 231\)](#)):
  1. Disassemble the case as described in [Disassembling the Case \(p. 183\)](#).
  2. Disconnect the invasive pressure cable (REF [21330-001526](#)) from the J7 connector on the system PCB (A01).
  3. Remove the parameter bezel as described in [Removing the Parameter Bezel \(p. 297\)](#).
  4. Remove the eight screws and captured washers that secure the IP connectors to the parameter bezel.
  5. Remove the IP connectors and gaskets. Discard the screws and gaskets.

### Installing the Invasive Pressure Connector Assembly (W33)

- ◆ To install the Invasive Pressure Connector Assembly into the rear case (refer to [Inside Rear Case Diagrams \(p. 231\)](#)):

**NOTE:** When installing a new invasive pressure connector, use the [Invasive Pressure Connector Repair Kit \(REF 40577-000034\) \(p. 482\)](#).

  1. Secure the IP connectors and new gaskets (REF [21300-001315](#)) to the parameter bezel with the eight new screws (REF [21300-007297](#)); torque to 6.8 in-lb. (See [Figure 9.13 on p. 381](#) for connector orientation.)

#### CAUTION

**POSSIBLE MOISTURE LEAKAGE** When installing the cable, use new gaskets to help prevent ingress of fluids.

2. Install the parameter bezel as described in [Installing the Parameter Bezel \(p. 299\)](#).
3. Connect the IP connector cable (REF [21330-001526](#)) to the system PCB (A01) at J7.
4. Reassemble the case as described in [Reassembling the Case \(p. 186\)](#).

### Temperature Cable Assembly (W35) Replacement

Temperature cable assembly replacement consists of the following procedures:

- [Removing the Temperature Cable Assembly \(W35\) \(p. 344\)](#)
- [Installing the Temperature Cable Assembly \(W35\) \(p. 344\)](#)

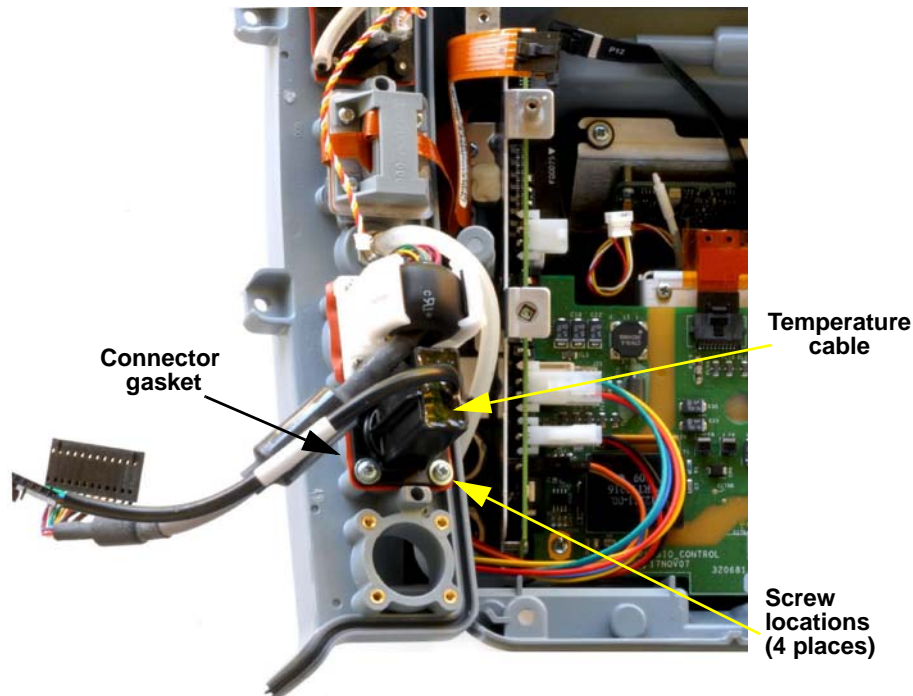

**Note:**  
Align ECG Ferrite as shown prior to installation into unit.

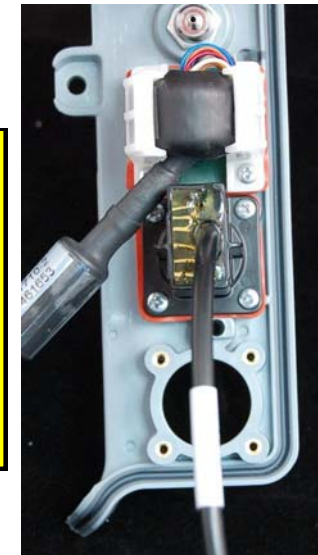

Figure 8.108—Temperature cable parts and screw locations

### Removing the Temperature Cable Assembly (W35)

- ◆ To remove the temperature cable assembly from the rear case (refer to [Inside Rear Case Diagrams \(p. 231\)](#)):
  1. Disassemble the case as described in [Disassembling the Case \(p. 183\)](#).
  2. Disconnect the temperature cable assembly from the J7 connector on the system PCB (A01).
  3. Remove the parameter bezel as described in [Removing the Parameter Bezel \(p. 297\)](#).
  4. Remove the four screws and captured washers that secure the temperature connector to the parameter bezel.
  5. Remove the temperature connector and gasket. Discard the screws and gasket.

### Installing the Temperature Cable Assembly (W35)

- ◆ To install the temperature cable assembly into the rear case (refer to [Inside Rear Case Diagrams \(p. 231\)](#)):

**NOTE:** When installing a new temperature cable assembly, use the [Temperature Cable Repair Kit \(REF 40577-000040\) \(p. 496\)](#).

1. Place the temperature connector and new gasket (REF [21300-001315](#)) into the second connector mounting hole up from the bottom of the parameter bezel. Secure the temperature connector with four new screws (REF [21300-007297](#)); torque to 6.8 in-lb. (See [Figure 8.108 on p. 343](#) for connector orientation.)

#### CAUTION

**POSSIBLE MOISTURE LEAKAGE** When installing the cable, use new seal to help prevent ingress of fluids.

2. Install the parameter bezel as described in [Installing the Parameter Bezel \(p. 299\)](#).
3. Connect the temperature cable assembly (REF [21330-001522](#)) to the system PCB (A01) at J7.
4. Reassemble the case as described in [Reassembling the Case \(p. 186\)](#).

## Contact PCB (A07) Replacement

Contact PCB replacement consists of the following procedures:

- [Removing the Contact PCB \(A07\) \(p. 345\)](#)
- [Installing the Contact PCB \(A07\) \(p. 345\)](#)

### Removing the Contact PCB (A07)

- ◆ To remove the contact PCB (from outside the rear case) (see [Figure 9.16 on p. 388](#)):
  1. Lay the device face down on a static-free, non-abrasive surface.
  2. Remove the two screws from the battery retainer between the battery wells. Lift away the battery retainer. Discard the screws.
  3. Lift the Contact PCB away for rear case far enough to access and disconnect the power/contact PCB cable (W05) at J42.

### Installing the Contact PCB (A07)

- ◆ To install the contact PCB (REF [21330-001288](#)) on the outside of the rear case:
  1. Lay the device face down on a static-free, non-abrasive surface.
  2. Connect the contact PCB to the power/contact PCB cable (W05) at J42.
  3. Install the contact PCB by sliding the assembly straight down tracks in rear case.
  4. Install the two new screws (REF [21300-000777](#)) into the battery retainer (REF [21330-001276](#)) between the battery wells; torque to 10.0 in-lb using P2 bit.

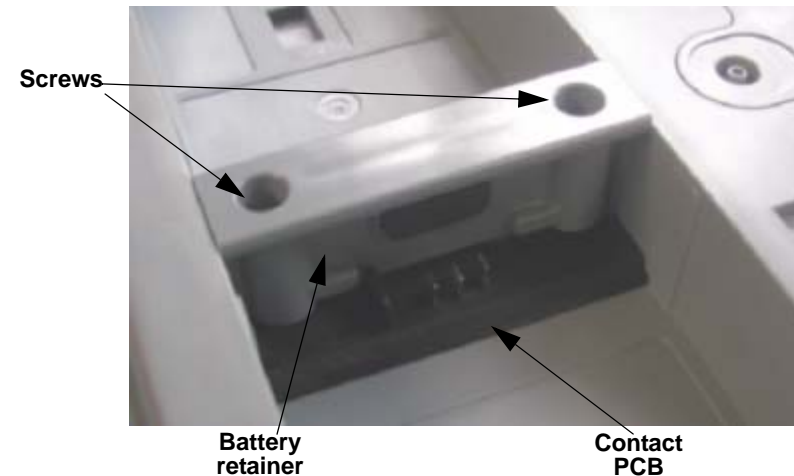

Figure 8.109—Contact PCB screw and part locations

### Printer Assembly (A12) Replacement

Printer assembly replacement consists of the following procedures:

- [Removing the Printer Assembly \(A12\) \(p. 346\)](#)
- [Installing the Printer Assembly \(A12\) \(p. 347\)](#)

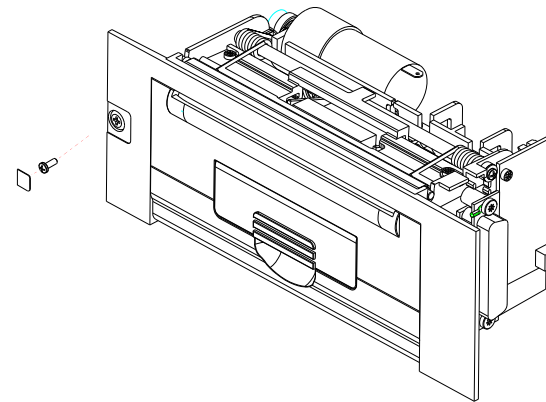

Figure 8.110—Printer assembly replacement

### Removing the Printer Assembly (A12)

- ◆ To remove the printer assembly from outside the front case:
  1. Lay the device face up on the battery wells.
  2. Remove the printer paper.
  3. Carefully peel away the label from the screw and loosen the screw.
  4. Open the printer door and loosen the two screws from inside the printer assembly.
  5. Grasp the door near the speaker side, and then gently pull up and push toward the speaker (to disengage the connector on the opposite side). Lift the printer out and set it aside.



### Installing the Printer Assembly (A12)

**NOTE:** The new printer comes with new screws installed to aid reassembly.

- ◆ To install the printer assembly into the front case.
  1. Lay the device face up on the battery wells.
  2. Insert the printer (REF [11241-000009](#)) into the front case, and then gently push toward the therapy connector (to engage the printer connector)
  3. Tighten the two screws from inside the printer assembly; torque to 10 in.lb using a P2 bit.
  4. Tighten the third screw on the outside left side of printer; torque to 10 in.lb.
  5. Apply a new screw cover label. Apply the screw cover label (#6) from the label set (Example, REF [21501-002408](#). See [Table 9.13 on page 408](#)) to the left front of printer.

**NOTE:** If printer paper was previously installed, re-installed printer paper.



- ◆ To replace the coin battery on the system PCB (A01) in the rear case (refer to [Inside Rear Case Diagrams \(p. 231\)](#)):
  1. Disassemble the case as described in [Disassembling the Case \(p. 183\)](#).
  2. With the new coin battery, (REF [21300-001052](#)) (type CR2032), at hand, lift up from below the coin battery to remove. The coin battery will pop out of the holder.
  3. To install, slide in the new battery with (+) terminal up, place battery into right side of battery holder first. Press down to secure (see [Figure 8.111 on p. 348](#)).
  4. Reentry of time and date will be required after the coin battery replacement.  
**NOTE:**The coin battery should be part of a five year replacement schedule (see [Scheduled Replacement Items \(p. 151\)](#)).

### Battery Pin Replacement



**Figure 8.112—Battery pins**

Inspect the battery connector pins as part of the routine physical inspection. Be sure to examine each leaf on the pins to ensure that they are not cracked or broken. Tighten any pins that are loose. Replace any pins that are bent, broken, corroded, worn, or damaged. Battery pins are replaced from outside the case.

- ◆ To replace a battery pin:
  1. Using a 4 mm modified socket, unscrew the pin and remove it.
  2. Torque the new battery pin (REF [21300-002023](#)) to 4 in-lb.

**NOTE:** The battery grommets are not replaceable. Complete the Rear Case Replacement as described in [Rear Case Replacement \(p. 301\)](#) procedure to repair damaged battery grommets.

### Software and Device Upgrades

The LIFEPAK 15 monitor/defibrillator device upgrade procedures require specialized training and entail information proprietary to Physio-Control. These procedures should only be performed by authorized Physio-Control personnel.

Device configuration settings and system software replacement require tools and procedures that are proprietary to Physio-Control. These procedures and tools may be available for use by customers using LIFENET System Asset Management products. Device configuration and software can also be installed by authorized Physio-Control service personnel.

Contact a Physio-Control customer service representative for assistance.

## Assembly Diagrams and Parts Lists

This section is a hierarchical reference used to identify components needed to repair the LIFEPAK 15 monitor/defibrillator.

- [Section Glossary \(p. 353\)](#)—Defines terms used in this section
- [Main Diagrams \(p. 354\)](#)—Shows the assembly diagram configurator and interconnect diagram with links to detailed assemblies and parts by catalog number
- [Front Parts Diagrams and Parts List \(p. 364\)](#)—Includes multiple diagrams and table of parts for the front of the device
- [System/Therapy PCB Assembly Diagrams and Parts Lists \(p. 373\)](#)—Includes multiple diagrams and tables of parts for the assemblies of the device
- [Rear Diagrams and Parts List \(p. 386\)](#)—Includes multiple diagrams and table of parts for the rear of the device
- [OEM Optional Assemblies, Diagrams and Parts Lists \(p. 397\)](#)—Includes multiple diagrams and tables of parts for the assemblies of the device
- [LIFEPAK 15 3rd Edition Label Set - Languages \(p. 417\)](#)—Includes diagrams for parts illustrating connections
- [Repair Kits \(p. 478\)](#)—Contains all items needed to replace major components with separate catalog numbers for each kit
- [Ordering Parts \(p. 502\)](#)—To obtain replacement parts for the device by catalog number
- [Defibrillator Part Number and Serial Number \(p. 501\)](#)—Useful for decoding the SN on the device label, which displays the manufacturing code

**NOTE:** To view lists of catalog numbers for language options (for example, labels and keypads), click the **Select other language** link (if available) in the Note column of a parts list.

**NOTE:** For additional parts lists, including items necessary to keep the device in clinical service, see [Devices, Options, Supplies, and Accessories \(p. 64\)](#).

### Section Glossary

The following are definitions of terms used in this section.

- **Common parts** are components used in every version of the defibrillator device, regardless of options and operating language. Common parts are divided into Front Case, Rear Case, and System/Therapy PCB Assembly.
- **Internal parts** are components internal to the case that are specific to your device.
- **External parts** are components external to the case that are specific to your device.
- The **Item** number on diagrams (used most often for cables and connectors) provides a reference number for parts on the device. Click on the item number in a diagram to jump to that part.
- The **Quantity** column identifies how many of the listed part is used in the assembly.
- **CAT.** number is used for ordering each part.
- The **Part Description** column provides a brief description of each part in the parts list.
- **Options** are assemblies that are not required on the basic device and can be specified by the customer when purchased. Parts on these assemblies may be referred to as optional parts.
- **V1** (Version 1) refers to LIFEPAK 15 devices that do **not** have the auxiliary power feature.
- **V2** (Version 2) refers to LIFEPAK 15 devices that have the auxiliary power feature. A device must be V2-equivalent to order the Temperature option.
- **V4** (Version 4) has all the features of V2, but with revised System PCB, Therapy PCB, capacitor, and therapy cable. The Biphasic module assembly and transfer relay were removed. V4 devices are designated by the V4 gear symbol on the serial number label. See [Symbols \(p. 36\)](#) and [Defibrillator Part Number and Serial Number \(p. 501\)](#).
- **3rd Edition** refers to labels that have been updated to be compliant with EN 60601-1:2006+A1:2013 Medical Electrical Equipment - Part 1: General Requirements for Basic Safety and Essential Performance, 3rd Edition, and the associated Particular and Collateral Standards. See [LIFEPAK 15 3rd Edition Label Set - Languages \(p. 417\)](#)

### Main Diagrams

Use the following diagrams for an overview of the device:

- Assembly Diagram Configurator ([Figure 9.1 on p. 355](#))—shows the main parts of the device with links to detailed assembly diagrams.
- Interconnect Diagram ([Figure 9.2 on p. 356](#))—shows detailed assembly and cable interconnect information and provides links to each part diagram.



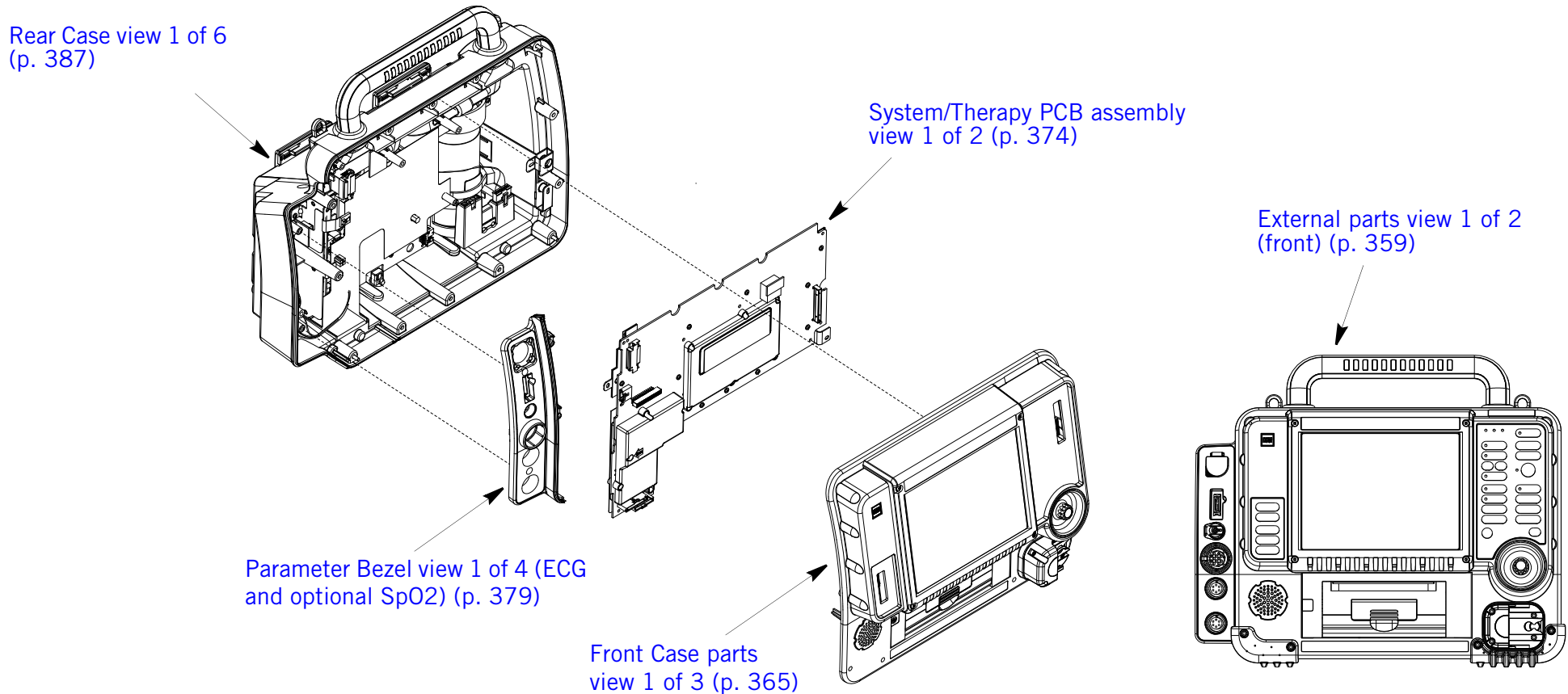

Figure 9.1—Assembly diagram configurator

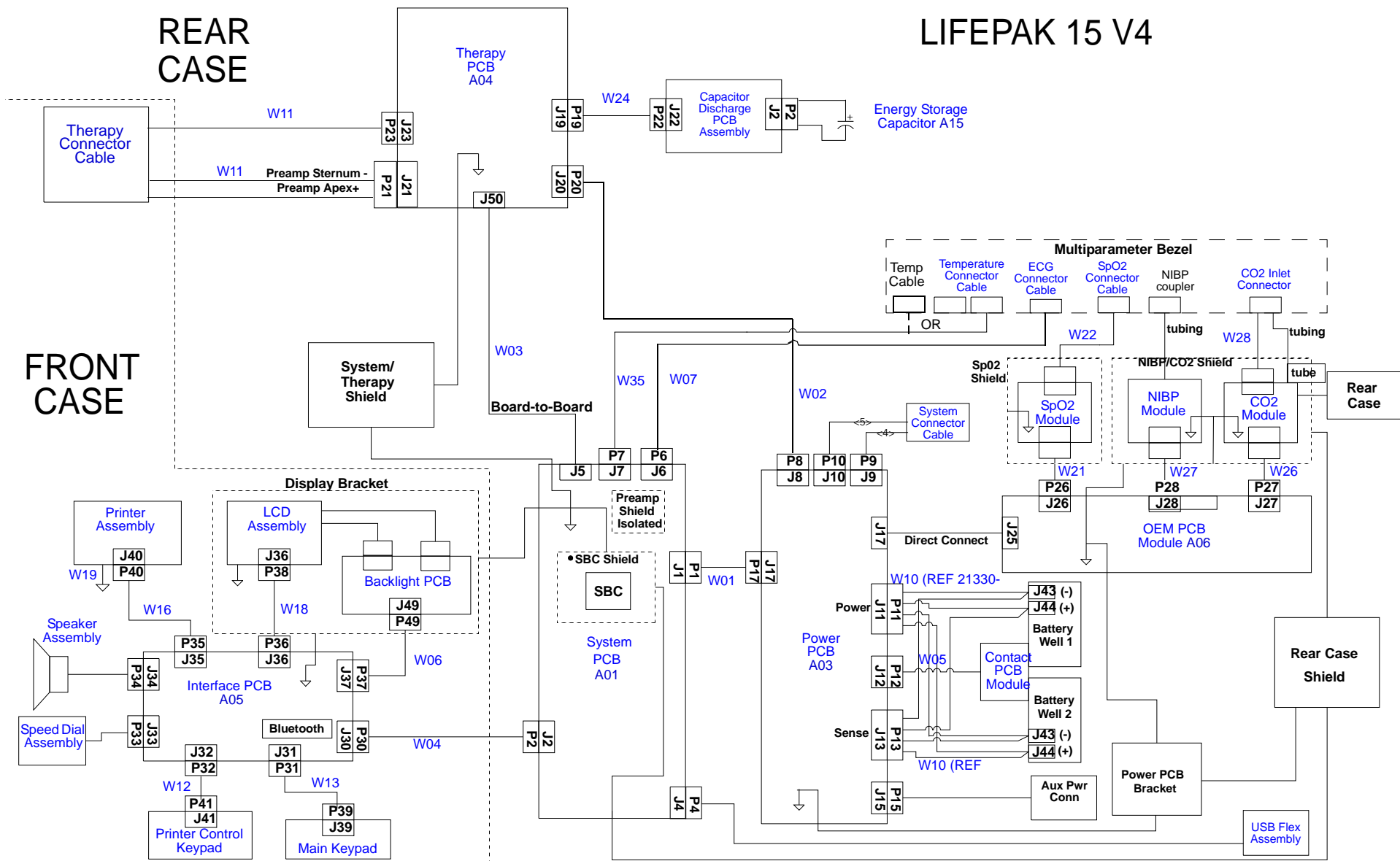

Figure 9.2— Interconnect diagram with detailed assembly, cable interconnect information, and links to each part diagram with power PCB (REF 21330-001531).

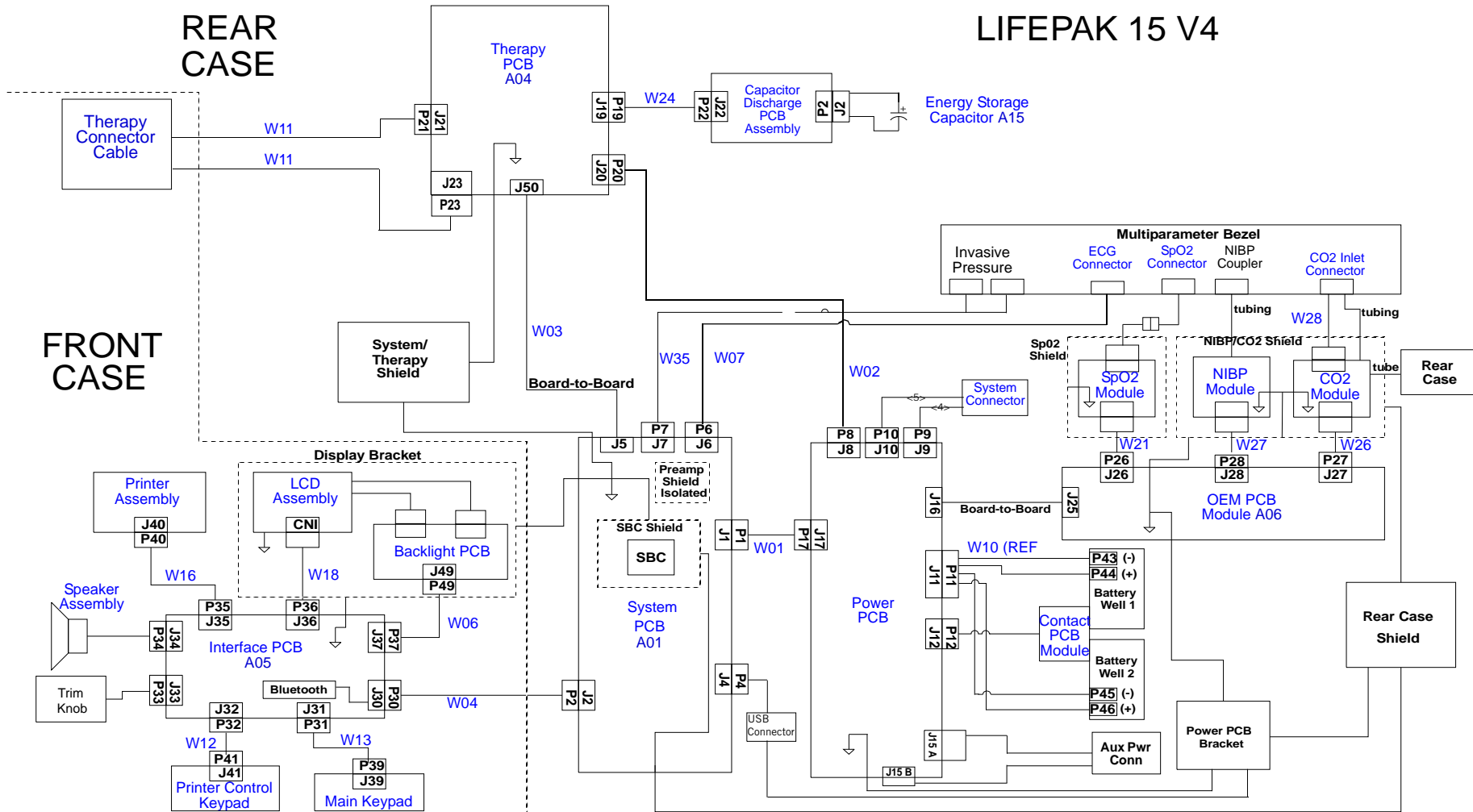

Figure 9.3—Interconnect diagram with detailed assembly, cable interconnect information, and links to each part diagram with power PCB (REF 21330-001531).

### External Parts Diagrams and Lists

External parts includes the following:

- [External and Configured Parts Diagram — Page 1 of 2 \(p. 359\)](#)
- [External and Configured Parts Diagram — Page 2 of 2 \(p. 360\)](#)
- [External Parts List \(p. 361\)](#)
- [Carrying Case Replacement Parts \(p. 363\)](#)

### External and Configured Parts Diagram — Page 1 of 2

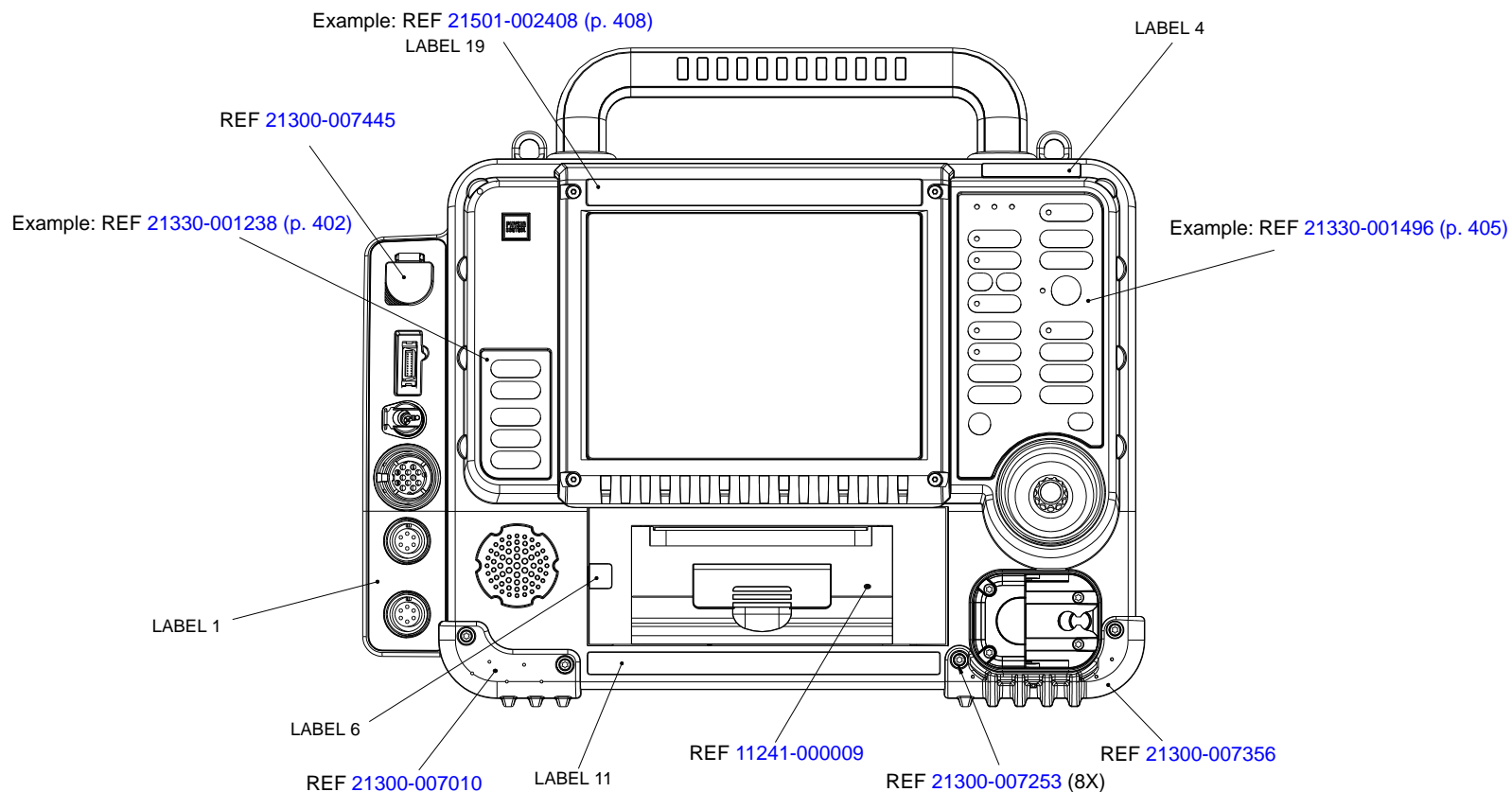

Figure 9.4—External parts view 1 of 2 (front)

### External and Configured Parts Diagram — Page 2 of 2

Example: REF 21501-002408 (p. 408)

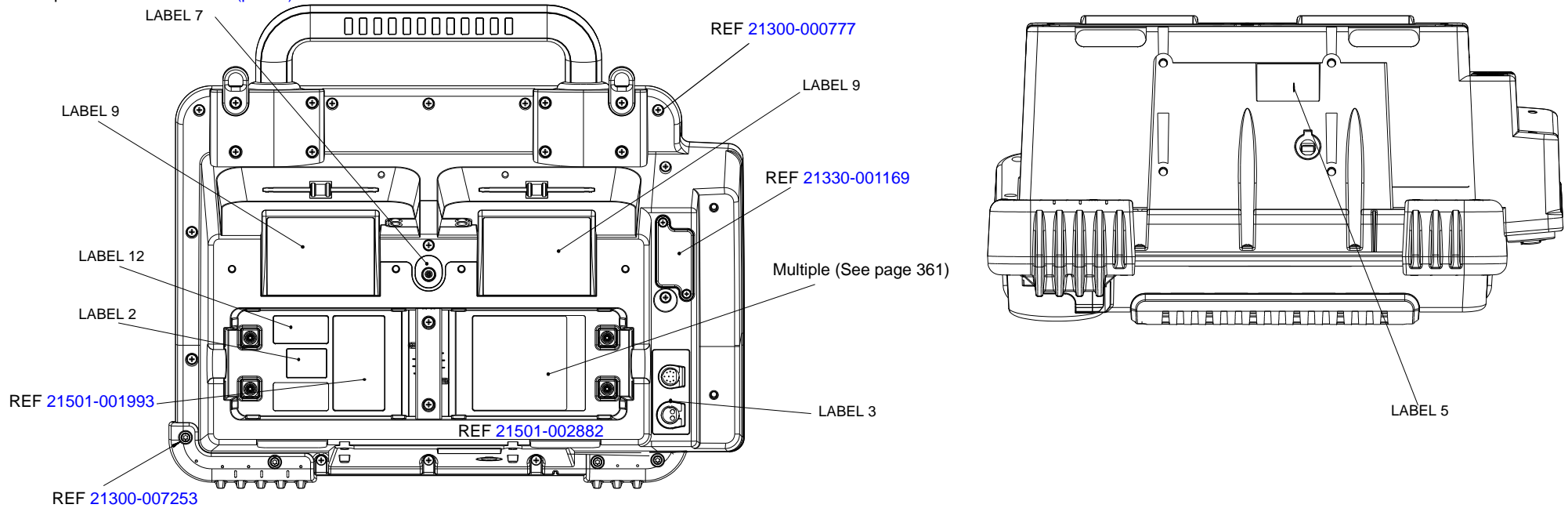

Figure 9.5—External parts view 2 of 2 (rear)

### External Parts List

Table 9.1—External Parts

CAT.	Qty	Description	Notes
Multiple	1	LABEL SET, language and feature-specific	Refer to Label Set family drawing section, <a href="#">Figure 9.4 on p. 359</a> and <a href="#">Figure 9.5 on p. 360</a> . See <a href="#">LIFEPAK 15 Label Set - Languages (p. 408)</a>
Multiple	1	A10 - KEYPAD ASSY - MAIN CNTRL	Refer to <a href="#">Figure 9.4 on p. 359</a> . See <a href="#">A10 Main Keypad - Languages (p. 405)</a>
Multiple	1	A09 - KEYPAD ASSY - PRINTER CONTROL	Refer to <a href="#">Figure 9.4 on p. 359</a> . See <a href="#">A09- Printer Control Keypad - Languages (p. 402)</a>
21300-007445	1	Cover - CO2 Connector	Refer to <a href="#">External and Configured Parts Diagram — Page 1 of 2 (p. 359)</a>
11241-000009	1	PRINTER - 100 MM, GRAY WITH FERRITES	Refer to <a href="#">External and Configured Parts Diagram — Page 1 of 2 (p. 359)</a> . For cable interconnect view, see <a href="#">Figure 9.32 (p. 443)</a>
21330-001169	1	Door - Blank, USB	Refer to <a href="#">Figure 9.5 on p. 360</a>
21300-007356	1	Bumper (guard) - Corner, Lower right	Refer to <a href="#">External and Configured Parts Diagram — Page 1 of 2 (p. 359)</a> .
21300-007010	1	Bumper (guard) - Corner, Lower left	Refer to <a href="#">External and Configured Parts Diagram — Page 1 of 2 (p. 359)</a> .

**Table 9.1—External Parts (Continued)**

CAT.	Qty	Description	Notes
21300-007253	8	Screw - Cap, SCH, Rec, 15IP Torx Plus, 6-32x0.375L,SS	Refer to <a href="#">External and Configured Parts Diagram — Page 1 of 2 (p. 359)</a> and <a href="#">External and Configured Parts Diagram — Page 2 of 2 (p. 360)</a> .
Multiple	1	LABEL - SERIAL NUMBER, V4	Refer to <a href="#">External and Configured Parts Diagram — Page 2 of 2 (p. 360)</a>
21501-001993	1	LABEL - SpO2 MASIMO PATENT (For SpO2 option only)	Refer to <a href="#">External and Configured Parts Diagram — Page 2 of 2 (p. 360)</a>
21300-000777	14	SCREW, SEAL-SEAL, SELF-LOCK, 6-32 X 0.375	Refer to <a href="#">External and Configured Parts Diagram — Page 2 of 2 (p. 360)</a>
21501-002882	1	Label-UDI	Refer to <a href="#">External and Configured Parts Diagram — Page 2 of 2 (p. 360)</a>



### Carrying Case Replacement Parts

Replacement case parts include screws separately and the bag parts as shown in [Table 9.2](#) and [Table 9.3](#).

**Table 9.2—Screws for carrying cases**

CAT.	Qty	Description	Device - Mounting
21300-007429	4	8-32 x 0.312" Screw, Trusshead, Phillips, SS, Nylok Patch	mounts carry case at device bottom
21300-007966	2	¼-20 x 1.00" Screw, Panhead, Phillips, SS, Nylok Patch	mounts carry case at top holes
21300-001033	4	6-32 x 0.75" Screw, Panhead, Phillips, SS, Nylok Patch	mounts on rear pouch

**Table 9.3—LIFEPAK15 Carrying Case Parts**

CAT.	Qty	Description	Notes
11577-000002	1	Standard Carry Case (w/ Shoulder Strap)	
11260-000039	1	Back Pouch	
11577-000001	1	Shoulder Strap	
11220-000028	1	Top Pouch	

### Front Parts Diagrams and Parts List

Use the following front parts diagrams and table to identify parts in the front case.

- [Front Case parts view 1 of 3 \(p. 365\)](#)
- [Front Case parts view 2 of 3 \(p. 366\)](#)
- [Front Case parts view 3 of 3 \(p. 367\)](#)
- [Front Parts List \(p. 368\)](#)

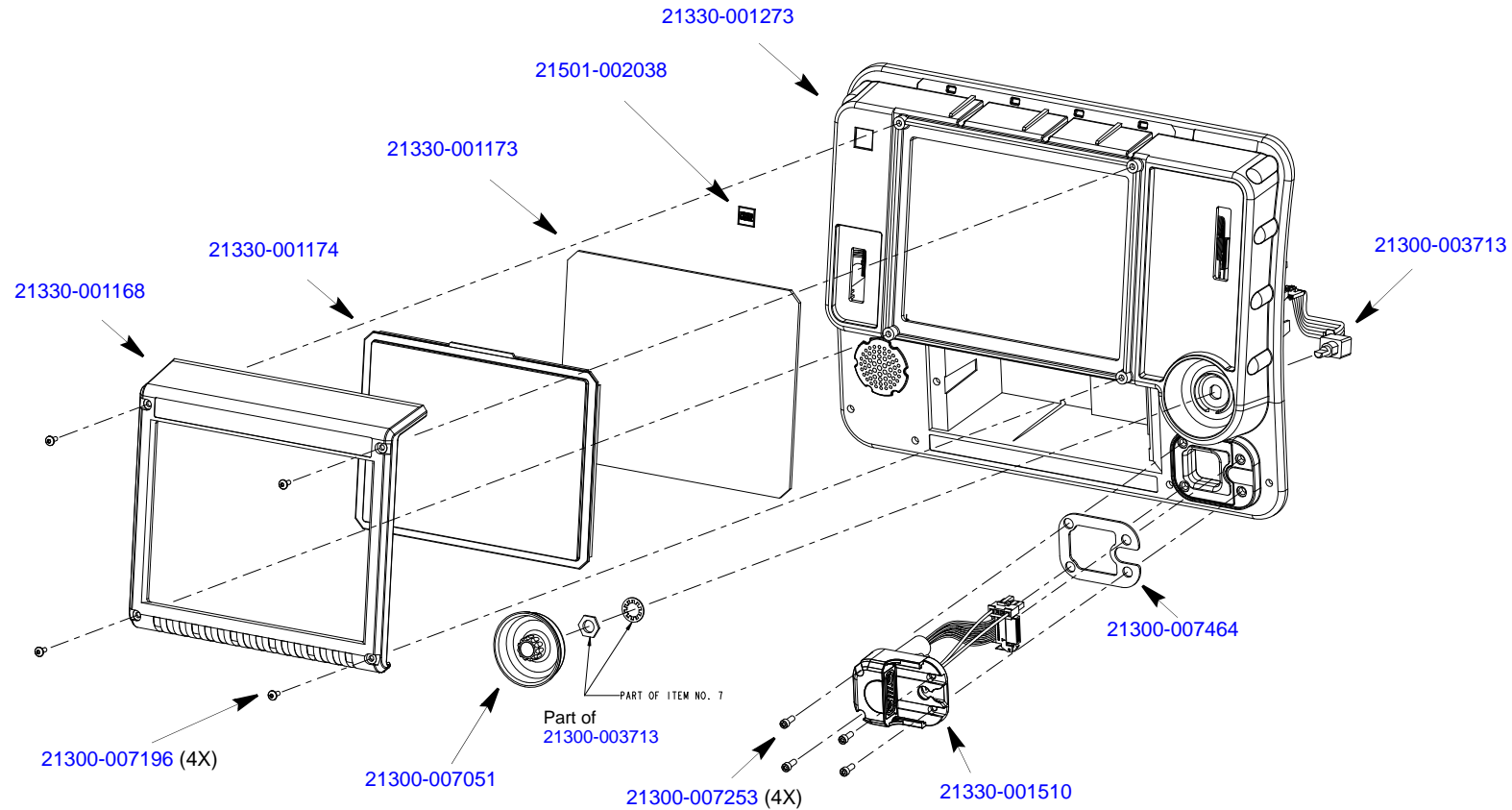

Figure 9.6—Front Case parts view 1 of 3

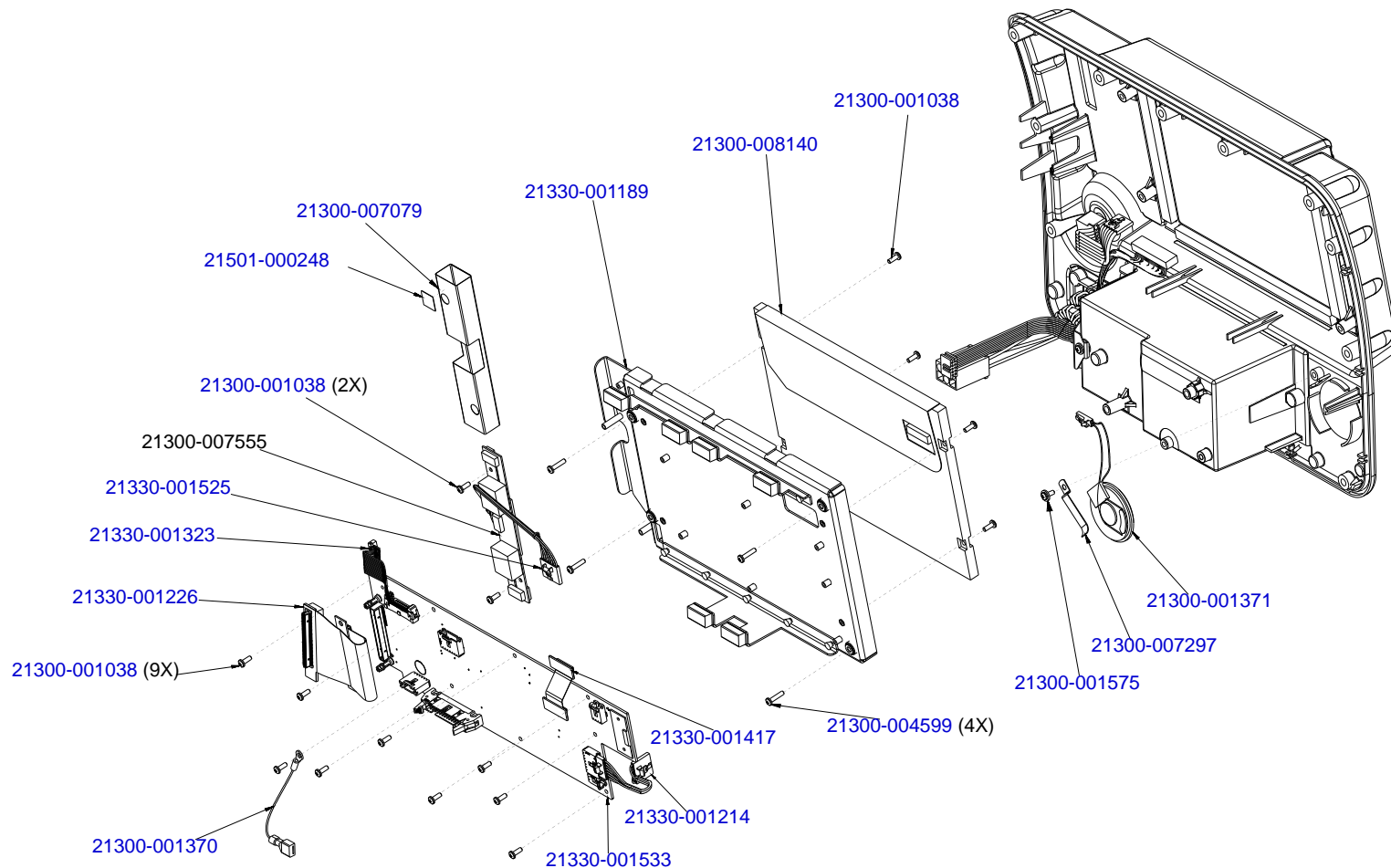

Figure 9.7—Front Case parts view 2 of 3

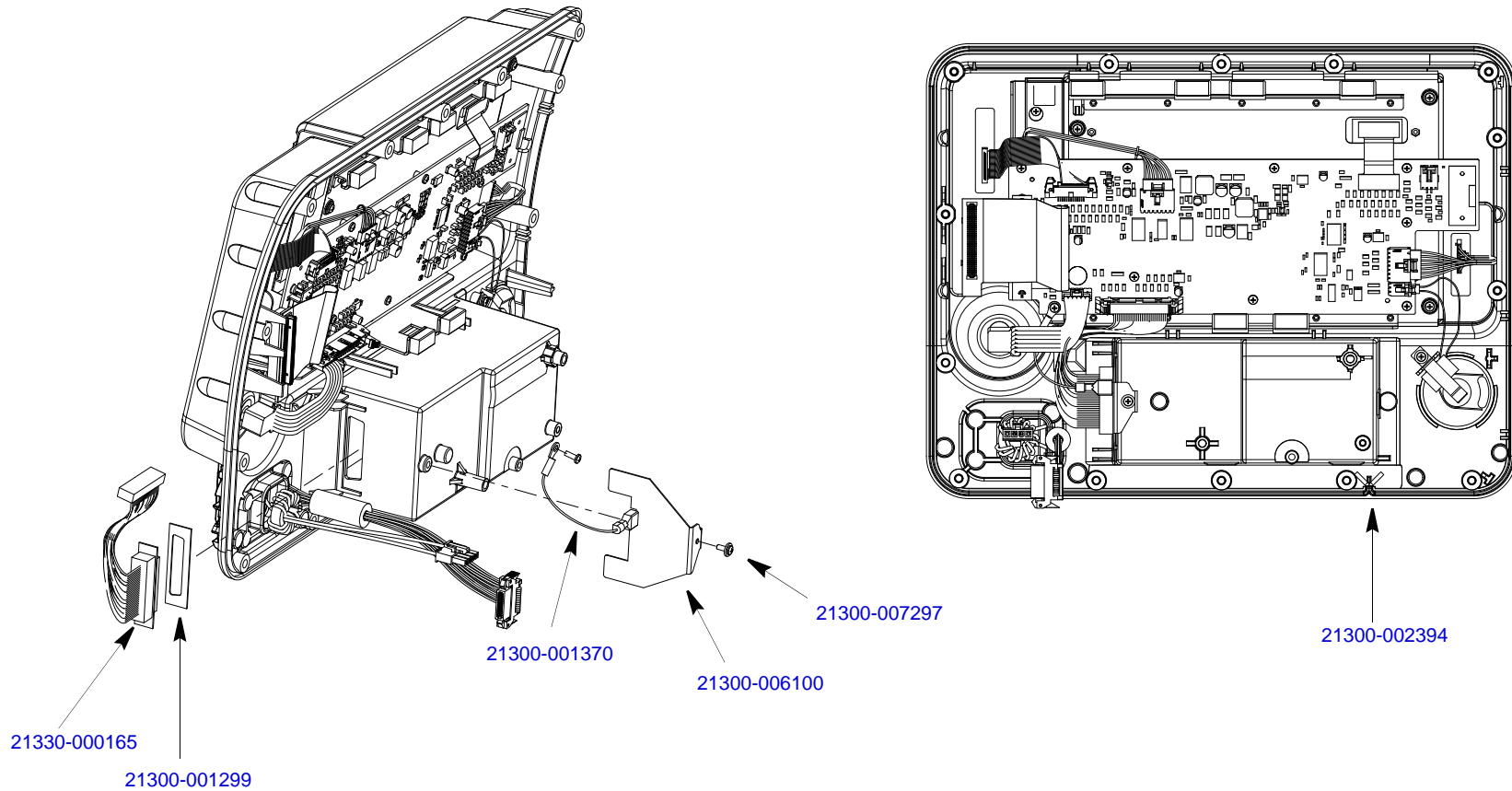

Figure 9.8—Front Case parts view 3 of 3

### Front Parts List

Table 9.4—Front Case Parts List

CAT.	Qty	Description	Notes
21300-001038	15	SCREW - M,CS,Z,PH, NYLOCK, 4-40 X .312L	Refer to <a href="#">Figure 9.7: Front Case parts view 2 of 3</a> , p. 366 and <a href="#">Figure 9.8: Front Case parts view 3 of 3</a> , p. 367.
21300-004599	4	SCREW, MACHINE, PANHEAD, NYLOK,4-40 X .500	Refer to <a href="#">Figure 9.7: Front Case parts view 2 of 3</a> , p. 366.
21300-001299	1	GASKET, PRINTER, SUB-D	Refer to <a href="#">Figure 9.8: Front Case parts view 3 of 3</a> , p. 367.
21300-006100	1	BRACKET, CONNECTOR, SUBD	Refer to <a href="#">Figure 9.8: Front Case parts view 3 of 3</a> , p. 367.
21330-000165	1	W16 - CABLE ASSY, RIBBON, INTERFACE PCB/CHART RCDR	Refer to <a href="#">Figure 9.8: Front Case parts view 3 of 3</a> , p. 367. For cable interconnect view, see <a href="#">Figure 9.54 on p. 465</a> .
21300-001370	1	W19 - WIRE HARNESS - GROUND/PRINTER BRKT	Refer to <a href="#">Figure 9.7: Front Case parts view 2 of 3</a> , p. 366 and <a href="#">Figure 9.8: Front Case parts view 3 of 3</a> , p. 367. For cable interconnect view, see <a href="#">Figure 9.57 on p. 468</a>
21300-001371	1	W17 - WIRE HARNESS - SPEAKER INTERFACE PCB	Refer to <a href="#">Figure 9.7: Front Case parts view 2 of 3</a> , p. 366. For cable interconnect view, see <a href="#">Figure 9.55 on p. 466</a> .

**Table 9.4—Front Case Parts List (Continued)**

CAT.	Qty	Description	Notes
21300-003713	1	W15 - SWITCH - ROTARY	Refer to <a href="#">Figure 9.6: Front Case parts view 1 of 3</a> , p. 365.
21300-001575	1	SPRING, CLAMP, STAINLESS STEEL	Refer to <a href="#">Figure 9.7: Front Case parts view 2 of 3</a> , p. 366.
21300-008140	1	A11 - DISPLAY - ACTIVE MATRIX, 8.4, COLOR	Refer to <a href="#">Figure 9.7: Front Case parts view 2 of 3</a> , p. 366. For cable interconnect view, see <a href="#">Figure 9.31</a> on p. 442. Repair kit, see <a href="#">Display Repair Kit (REF 40577-00044)</a> (p. 486).
21330-001173	1	LENS - DISPLAY	Refer to <a href="#">Figure 9.8: Front Case parts view 3 of 3</a> , p. 367. Repair kit, see <a href="#">Front Case Repair Kit (REF 40577-000010)</a> (p. 492).
21330-001174	1	SHIELD - DISPLAY	Refer to <a href="#">Figure 9.6: Front Case parts view 1 of 3</a> , p. 365. Repair kit, see <a href="#">Display Shield Repair Kit (REF 40577-000006)</a> (p. 489).
21330-001168	1	FRAME - DISPLAY SHIELD	Refer to <a href="#">Figure 9.6: Front Case parts view 1 of 3</a> , p. 365. Repair kit, see <a href="#">Display Shield Repair Kit (REF 40577-000006)</a> (p. 489).
21330-001533	1	A05 - PCB ASSY - INTERFACE (V2)	Refer to <a href="#">Figure 9.7: Front Case parts view 2 of 3</a> , p. 366. For cable interconnect view, see <a href="#">Figure 9.25</a> (p. 436). Repair kit, see <a href="#">Interface PCBA Repair Kit, (REF 40577-000042)</a> (p. 498).

**Table 9.4—Front Case Parts List (Continued)**

CAT.	Qty	Description	Notes
21330-001189	1	BRACKET - LCD DISPLAY MOUNTING	Refer to <a href="#">Figure 9.7: Front Case parts view 2 of 3</a> , p. 366.
21330-001214	1	W12 - CABLE ASSY - PRINTER CONTROL KEYPAD, INTERFACE PCB	Refer to <a href="#">Figure 9.7: Front Case parts view 2 of 3</a> , p. 366. For cable interconnect view, see <a href="#">Figure 9.50</a> (p. 461).
21330-001417	1	W18 - CABLE ASSY-FLEX, LCD, INTERFACE PCB	Refer to <a href="#">Figure 9.7: Front Case parts view 2 of 3</a> , p. 366. For cable interconnect view, see <a href="#">Figure 9.56</a> (p. 467).
21330-001226	1	W04 - CABLE ASSY - FLEX, SYSTEM PCB/INTERFACE PCB	Refer to <a href="#">Figure 9.7: Front Case parts view 2 of 3</a> , p. 366.
21330-001525	1	W06 - CABLE ASSY - BACKLIGHT INV, INTERFACE PCB	Refer to <a href="#">Figure 9.7: Front Case parts view 2 of 3</a> , p. 366. For cable interconnect view, see <a href="#">Figure 9.43</a> (p. 454).
21300-007051	1	KNOB - ROTARY SWITCH	Refer to <a href="#">Figure 9.6: Front Case parts view 1 of 3</a> , p. 365.
21330-001510	1	W11 - THERAPY CONNECTOR, INTERNAL	Refer to <a href="#">Figure 9.6: Front Case parts view 1 of 3</a> , p. 365. Repair kit, see <a href="#">Therapy Connector Repair Kit (REF 40577-000033)</a> (p. 485)
21300-007079	1	SHIELD, INVERTER	Refer to <a href="#">Figure 9.7: Front Case parts view 2 of 3</a> , p. 366.



**Table 9.4—Front Case Parts List (Continued)**

CAT.	Qty	Description	Notes
21300-007297	2	SCREW-MACH, PNH, PHH, NYLOCK, 4-40, 0.312L, WSHR, CS, ZN	Refer to <a href="#">Figure 9.7: Front Case parts view 2 of 3</a> , p. 366 and <a href="#">Figure 9.8: Front Case parts view 3 of 3</a> , p. 367
21300-007253	4	SCREW-CAP, SCH, REC 15IP TORX PLUS, 6-32, 0.375L, SS	Refer to <a href="#">Figure 9.6: Front Case parts view 1 of 3</a> , p. 365.
21300-007196	4	SCREW-MACH, TRH, T10 TORX, 4-40, 0.312L, SS	Refer to <a href="#">Figure 9.6: Front Case parts view 1 of 3</a> , p. 365.
21330-001323	1	W13 - CABLE-ASSY, MAIN KEYPAD, INTERFACE PCB	Refer to <a href="#">Figure 9.7: Front Case parts view 2 of 3</a> , p. 366. For cable interconnect view, see <a href="#">Figure 9.51</a> on p. 462.
21300-007464	1	SEAL - THERAPY RECEPTAC	Refer to <a href="#">Figure 9.6: Front Case parts view 1 of 3</a> , p. 365. Repair kit, see <a href="#">Therapy Connector Repair Kit (REF 40577-000033)</a> (p. 485).
21330-001273	1	ASSEMBLY - ENCLOSURE, FRONT	Refer to <a href="#">Figure 9.6: Front Case parts view 1 of 3</a> , p. 365. Repair kit, see <a href="#">Front Case Repair Kit (REF 40577-000010)</a> (p. 492).
21300-008138	1	A08 - DRIVER, LED BACKLIGHT, 12V DC, 85C	Refer to <a href="#">Figure 9.7: Front Case parts view 2 of 3</a> , p. 366. Repair kit, see <a href="#">Display Driver Repair Kit (REF 40577-000001)</a> (p. 486)
21501-002038	1	LABEL - PHYSIO-CONTROL ICON	Refer to <a href="#">Figure 9.6: Front Case parts view 1 of 3</a> , p. 365.

Table 9.4—Front Case Parts List (Continued)

CAT.	Qty	Description	Notes
21501-000248	1	LABEL - SYMBOL, INT'L	Refer to <a href="#">Figure 9.7: Front Case parts view 2 of 3</a> , p. 366.
21300-002394	1	SEAL - PERIMETER, CASE	Refer to <a href="#">Figure 9.7: Front Case parts view 2 of 3</a> , p. 366.

### System/Therapy PCB Assembly Diagrams and Parts Lists

Refer to the following diagrams and parts lists for assemblies.

- [System/Therapy PCB Assembly Diagrams and Parts List \(p. 374\)](#) includes:
  - ~ [System/Therapy PCB assembly view 1 of 2 \(p. 374\)](#)
  - ~ [System/Therapy PCB assembly view 2 of 2 \(p. 375\)](#)
  - ~ [System/Therapy Assembly Catalog Numbers \(p. 376\)](#)

### System/Therapy PCB Assembly Diagrams and Parts List

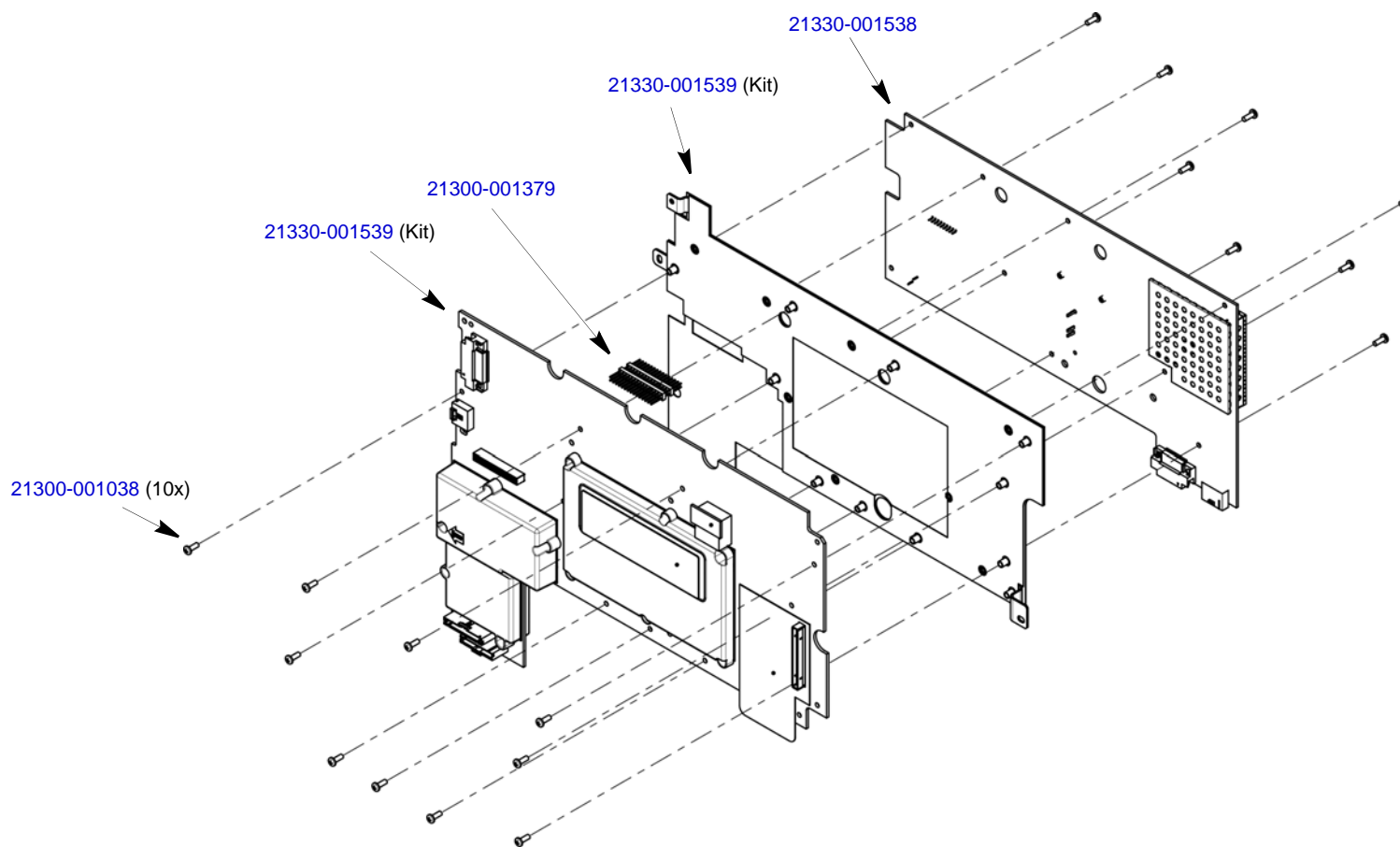

Figure 9.9—System/Therapy PCB assembly view 1 of 2

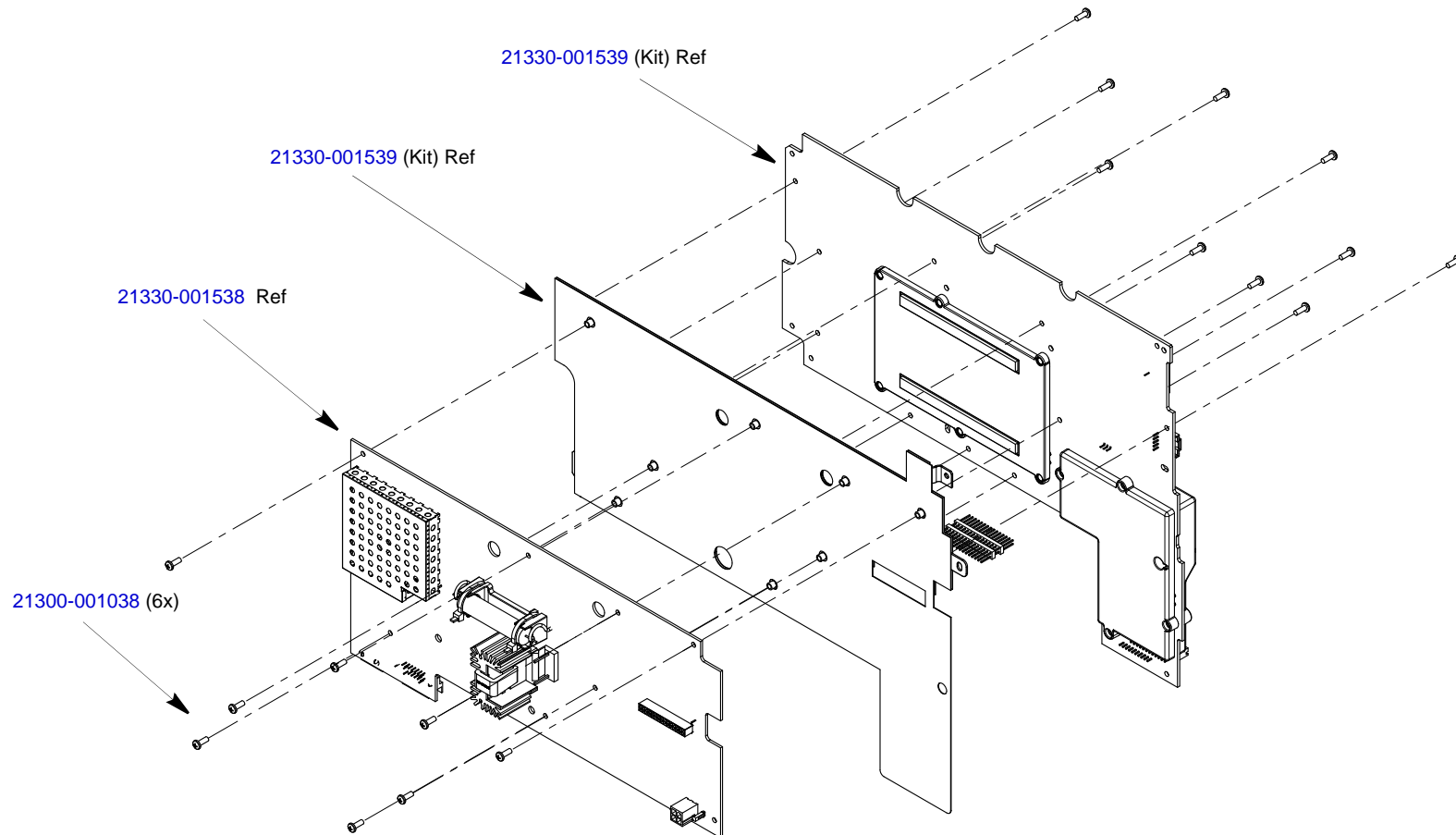

Figure 9.10—System/Therapy PCB assembly view 2 of 2

**Table 9.5—System/Therapy Assembly Catalog Numbers**

CATs	Qty	Description	Notes
21300-001038	18	SCREW-M, CS, Z, PH, NYLOCK, 4-40 X .312L	See <a href="#">System/Therapy PCB Assembly Diagrams and Parts List (p. 374)</a> and <a href="#">Figure 9.10: System/Therapy PCB assembly view 2 of 2, p. 375.</a>
21330-001538	1	A04 - PCB ASSY - THERAPY, BIPHASIC	See <a href="#">System/Therapy PCB Assembly Diagrams and Parts List (p. 374)</a> and <a href="#">Figure 9.10: System/Therapy PCB assembly view 2 of 2, p. 375.</a> For cable interconnect view, see <a href="#">Figure 9.22 on p. 433.</a> Repair kit see <a href="#">Therapy PCBA Repair Kit (REF 40577-000032) (p. 484).</a>
21300-001379	1	W03 - CONN-HDR, SQUAREPIN DUAL ROW, 30 PIN	See <a href="#">Figure 9.9: System/Therapy PCB assembly view 1 of 2, p. 374.</a> For cable interconnect view, see <a href="#">Figure 9.40 on p. 451</a>
21330-001539	1	A01 - PCB ASSY - SYSTEM	See <a href="#">System/Therapy PCB Assembly Diagrams and Parts List (p. 374)</a> . For cable interconnect view, see <a href="#">Figure 9.24 on p. 435.</a> Repair kit see <a href="#">System PCBA Repair Kit V4 (REF 40577-000031) (p. 500).</a>
21330-001539	1	ASSY - MOUNTING, BRACKET, SYSTEM, THERAPY PCB	See <a href="#">System/Therapy PCB Assembly Diagrams and Parts List (p. 374)</a> . Repair Kit, see <a href="#">System PCBA Repair Kit V4 (REF 40577-000031) (p. 500)</a>

Table 9.5—System/Therapy Assembly Catalog Numbers (Continued)

CATs	Qty	Description	Notes
21300-003172	1	SPACER - FOAM, SYS PCB CAPS	See <a href="#">System/Therapy PCB Assembly Diagrams and Parts List (p. 374)</a> .
21300-001052	1	COIN CELL BATTERY	

### Parameter Bezel Diagrams and Parts Lists

Refer to the following diagrams and parts lists for assemblies.

- [Parameter Bezel Diagrams and Parts List \(p. 379\)](#) includes:
  - ~ [Parameter Bezel view 1 of 4 \(ECG and optional SpO2\) \(p. 379\)](#)
  - ~ [Parameter Bezel view 2 of 4 \(optional CO2 and NIBP\) \(p. 380\)](#)
  - ~ [Parameter Bezel view 3 of 4 \(optional invasive pressure\) \(p. 381\)](#)
  - ~ [Parameter Bezel view 4 of 4 \(optional temperature cable assembly\) \(p. 382\)](#)
  - ~ [Bezel Parts List \(p. 383\)](#)



### Parameter Bezel Diagrams and Parts List

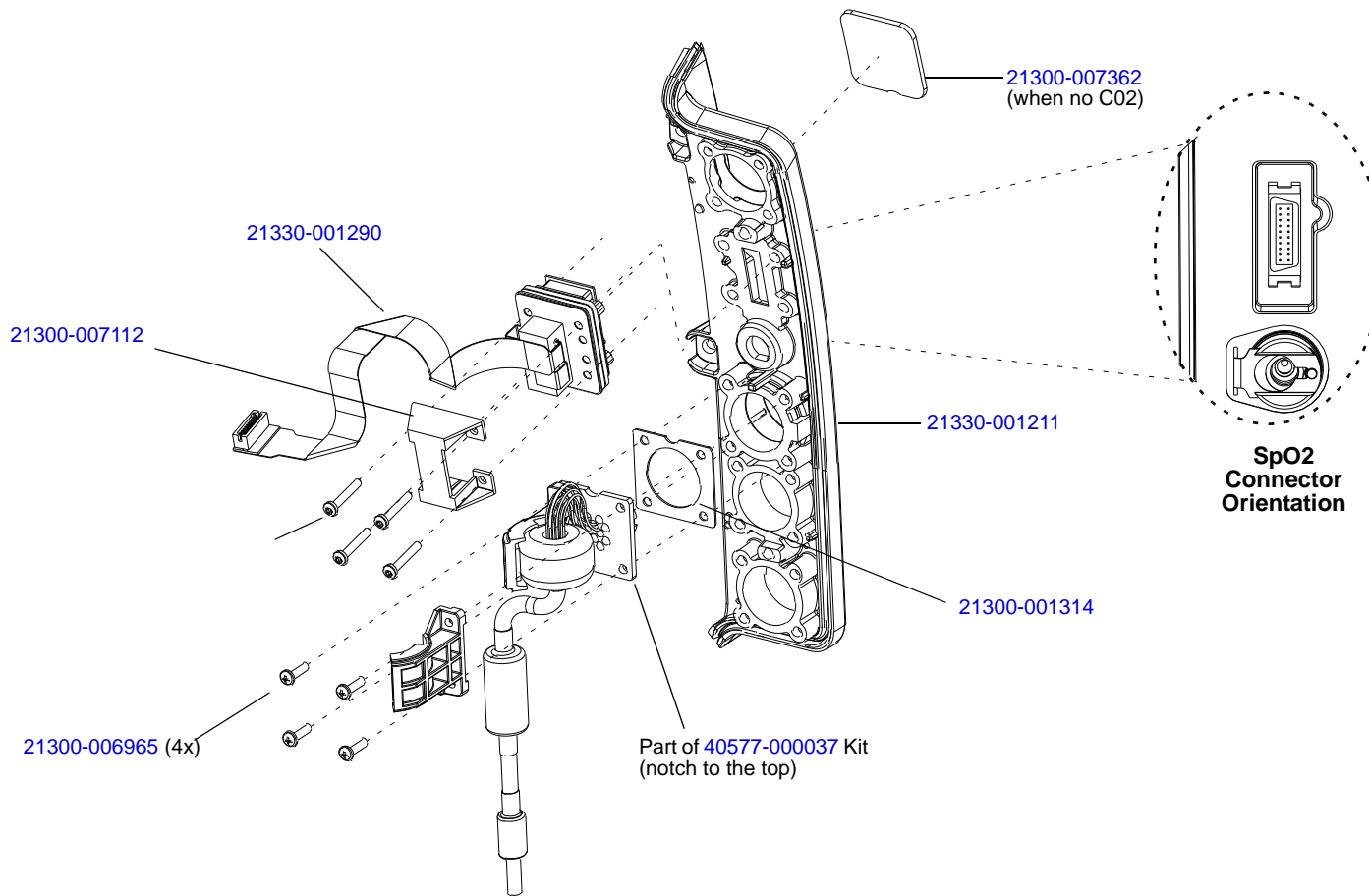

Figure 9.11—Parameter Bezel view 1 of 4 (ECG and optional SpO2)

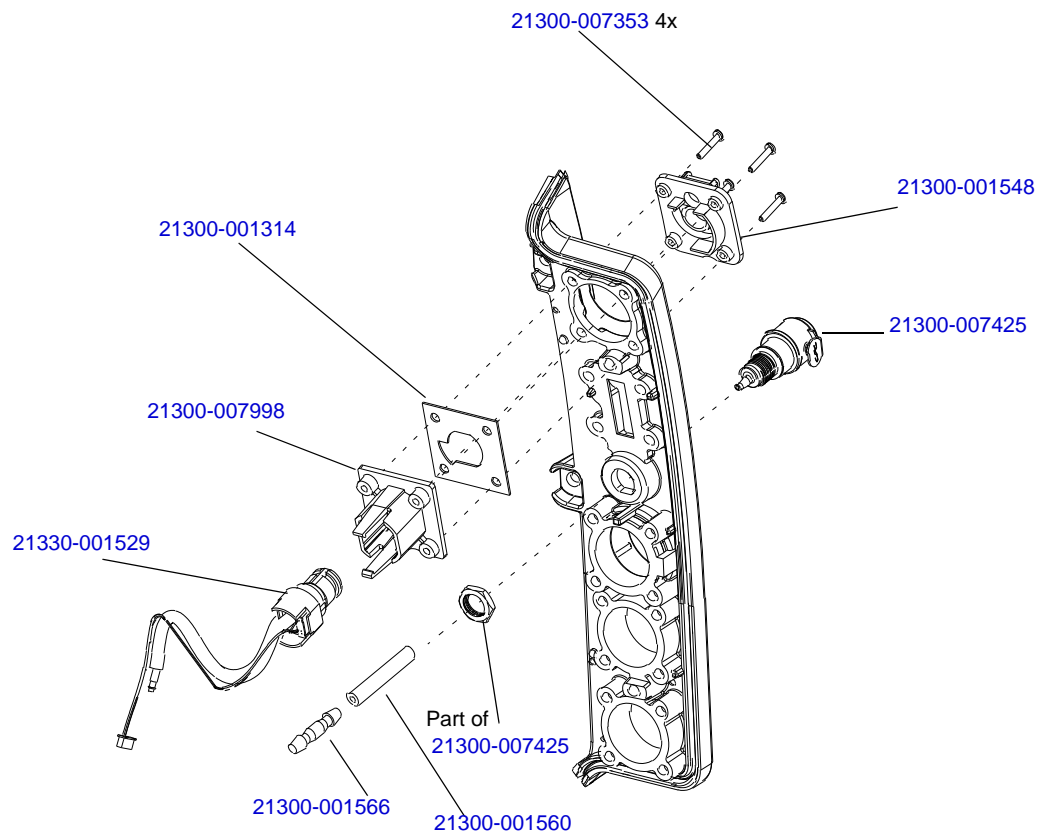

Figure 9.12—Parameter Bezel view 2 of 4 (optional CO2 and NIBP)

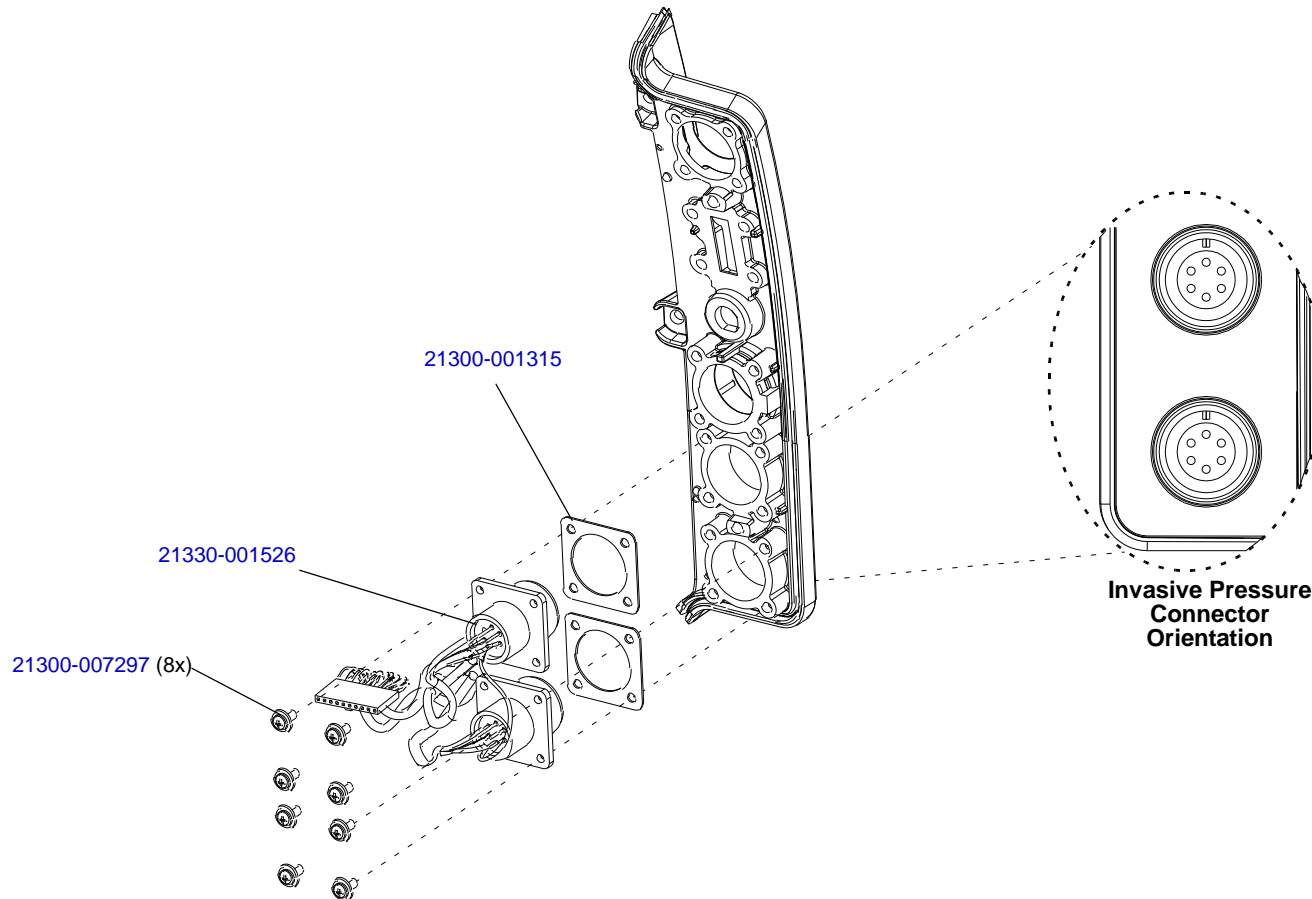

Figure 9.13—Parameter Bezel view 3 of 4 (optional invasive pressure)

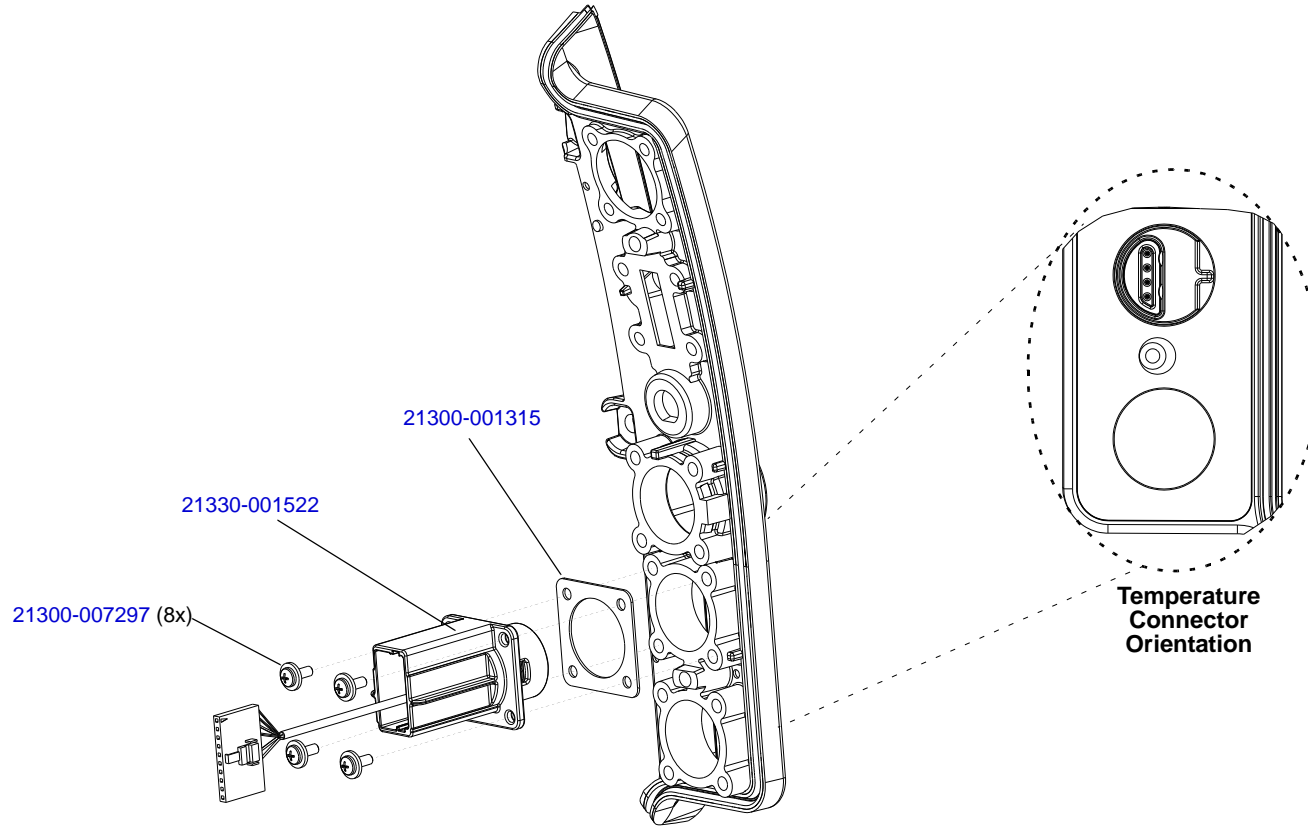

Figure 9.14—Parameter Bezel view 4 of 4 (optional temperature cable assembly)

**Table 9.6— Bezel Parts List**

CAT.	Qty.	Description	Notes
21300-007362	1	SPACER - CONNECTOR, CO2	This spacer is used in devices without CO2 feature. Refer to <a href="#">Figure 9.11: Parameter Bezel view 1 of 4 (ECG and optional SpO2)</a> , p. 379.
21330-001211	1	BEZEL - PARAMETER	Refer to <a href="#">Parameter Bezel Diagrams and Parts List (p. 379)</a> , <a href="#">Figure 9.11: Parameter Bezel view 1 of 4 (ECG and optional SpO2)</a> , p. 379, and <a href="#">Figure 9.13: Parameter Bezel view 3 of 4 (optional invasive pressure)</a> , p. 381.
N/A	1	W07 - RECEPTACLE-ECG,12 CONTACT, WIRED, ROHS	Refer to <a href="#">Figure 9.11: Parameter Bezel view 1 of 4 (ECG and optional SpO2)</a> , p. 379. For cable interconnect view, see <a href="#">Figure 9.44</a> on p. 455. Repair kit, see <a href="#">ECG Connector Repair Kit (REF 40577-000037)</a> (p. 485).
21300-002683	1	SEAL - ECG RECEPTACLE	Refer to <a href="#">Figure 9.11: Parameter Bezel view 1 of 4 (ECG and optional SpO2)</a> , p. 379.
21300-006304	2	BRACKET - CABLE SUPPORT, ASSY	Refer to <a href="#">Figure 9.11: Parameter Bezel view 1 of 4 (ECG and optional SpO2)</a> , p. 379.
21300-006965	4	SCREW, MACHINE, PANHEAD, NYLOK, 4-40 X .437	Refer to <a href="#">Figure 9.11: Parameter Bezel view 1 of 4 (ECG and optional SpO2)</a> , p. 379.
21330-001290	1	W22 - CABLE ASSY - FLEX, MASIMO, SpO2	Refer to <a href="#">Figure 9.11: Parameter Bezel view 1 of 4 (ECG and optional SpO2)</a> , p. 379. For cable interconnect view, see <a href="#">Figure 9.59</a> on p. 470. Repair kit, see <a href="#">OEM PCBA Repair Kit (REF 40577-000041)</a> (p. 497).

**Table 9.6— Bezel Parts List (Continued)**

CAT.	Qty.	Description	Notes
21300-007112	1	HOUSING - FERRITE, SpO2	Refer to <a href="#">Figure 9.11: Parameter Bezel view 1 of 4 (ECG and optional SpO2)</a> , p. 379.
21300-007557	4	SCREW - MACHINE, PAN, T10 - TORX, NYLOK, 4-40 X 0.6875L (SpO2)	Refer to <a href="#">Figure 9.11: Parameter Bezel view 1 of 4 (ECG and optional SpO2)</a> , p. 379.
21330-001529	1	W28 - FRS ASSEMBLY - CO2, MINI-MODULE, ROHS	Refer to <a href="#">Figure 9.12: Parameter Bezel view 2 of 4 (optional CO2 and NIBP)</a> , p. 380. For cable interconnect view, see <a href="#">Figure 9.63</a> on p. 474. Repair kit, see <a href="#">CO2 Connector Repair Kit (REF 40577-000038)</a> (p. 487).
21300-001314	1	SEAL - CO2 CONNECTOR	Refer to <a href="#">Figure 9.12: Parameter Bezel view 2 of 4 (optional CO2 and NIBP)</a> , p. 380.
21300-001548	1	ADAPTER - CO2 CONNECTOR	Refer to <a href="#">Figure 9.12: Parameter Bezel view 2 of 4 (optional CO2 and NIBP)</a> , p. 380.
21300-007998	1	RETAINER - CO2 CONN	Refer to <a href="#">Figure 9.12: Parameter Bezel view 2 of 4 (optional CO2 and NIBP)</a> , p. 380.
21300-007353	4	SCREW - MACH, NYLOK, PHH, 2-56 X 0.500, CS, ZN (CO2)	Refer to <a href="#">Figure 9.12: Parameter Bezel view 2 of 4 (optional CO2 and NIBP)</a> , p. 380.
21300-007425	1	CONNECTOR - PNEUMATIC COUPLER, NIBP	Refer to <a href="#">Figure 9.12: Parameter Bezel view 2 of 4 (optional CO2 and NIBP)</a> , p. 380. Repair kit, see <a href="#">NIBP Connector Repair Kit (REF 40577-000009)</a> (p. 491).
21300-001560	1	TUBING - NIBP	Refer to <a href="#">Figure 9.12: Parameter Bezel view 2 of 4 (optional CO2 and NIBP)</a> , p. 380.

**Table 9.6— Bezel Parts List (Continued)**

CAT.	Qty.	Description	Notes
21300-001566	1	CONN - PNEU, STR, 0.125ID NYLON, WHT (NIBP)	Refer to <a href="#">Figure 9.12: Parameter Bezel view 2 of 4 (optional CO2 and NIBP)</a> , p. 380.
21330-001526	1	W33 - WIRE HARNESS- INVASIVE PRESSURE 1- 2, ROHS	Refer to <a href="#">Figure 9.13: Parameter Bezel view 3 of 4 (optional invasive pressure)</a> , p. 381. For cable interconnect view, see <a href="#">Figure 9.66 on p. 477</a> . Repair kit, see <a href="#">Invasive Pressure Connector Repair Kit (REF 40577-000034)</a> (p. 482).
21300-001315	2	GASKET - CONNECTOR, INVASIVE PRESURE	Refer to <a href="#">Figure 9.13: Parameter Bezel view 3 of 4 (optional invasive pressure)</a> , p. 381 and <a href="#">Figure 9.14: Parameter Bezel view 4 of 4 (optional temperature cable assembly)</a> , p. 382.
21300-007297	8	SCREW - MACH, PNH, PHH, NYLOCK, 4-40 X 0.312L, WSHR, CS, ZN (IP)	Refer to <a href="#">Figure 9.13: Parameter Bezel view 3 of 4 (optional invasive pressure)</a> , p. 381.
21330-001522	1	W35 - CONNECTOR CABLE ASSEMBLY - TEMPERATURE, ROHS	Refer to <a href="#">Figure 9.14: Parameter Bezel view 4 of 4 (optional temperature cable assembly)</a> , p. 382.

### Rear Diagrams and Parts List

Use the following diagrams and parts list to identify parts in the rear case.

- [Rear Case view 1 of 6 \(p. 387\)](#)
- [Rear Case view 2 of 6 \(p. 388\)](#)
- [Rear Case view 3 of 6 \(p. 389\)](#)
- [Rear Case view 4 of 6 \(p. 390\)](#)
- [Rear Case view 5 of 6 \(p. 391\)](#)
- [Rear Case view 6 of 6 \(p. 392\)](#)
- [Rear Parts List \(p. 393\)](#)



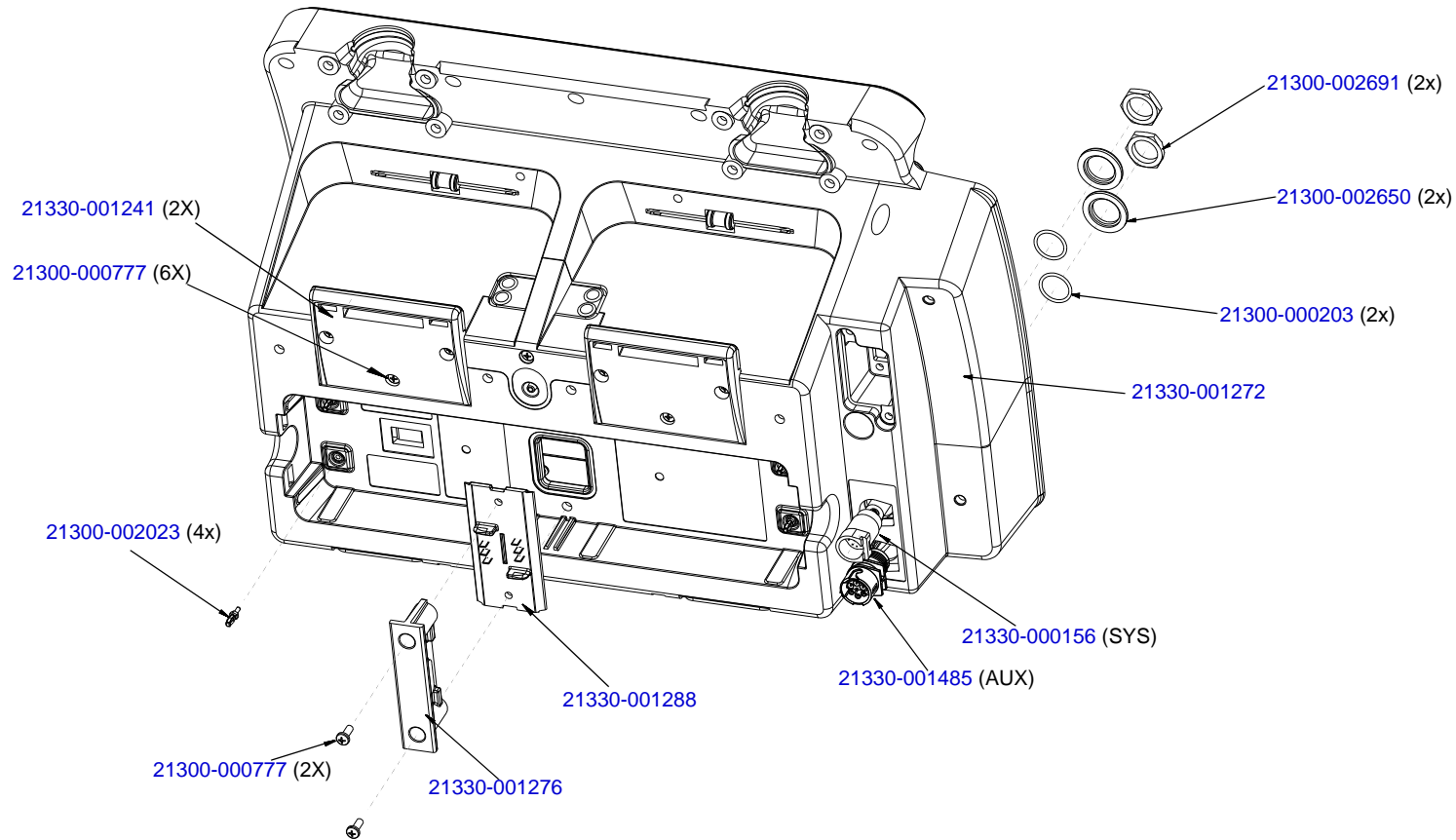

Figure 9.15—Rear Case view 1 of 6

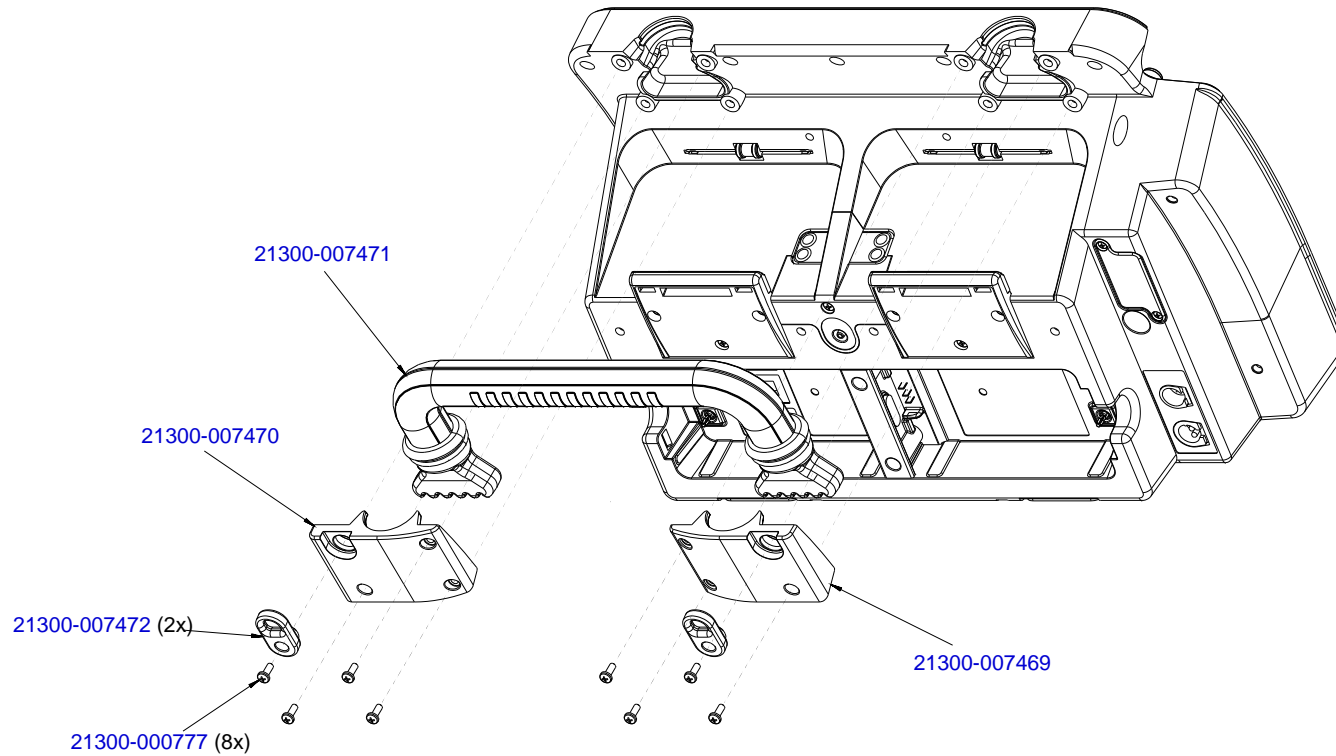

Figure 9.16—Rear Case view 2 of 6

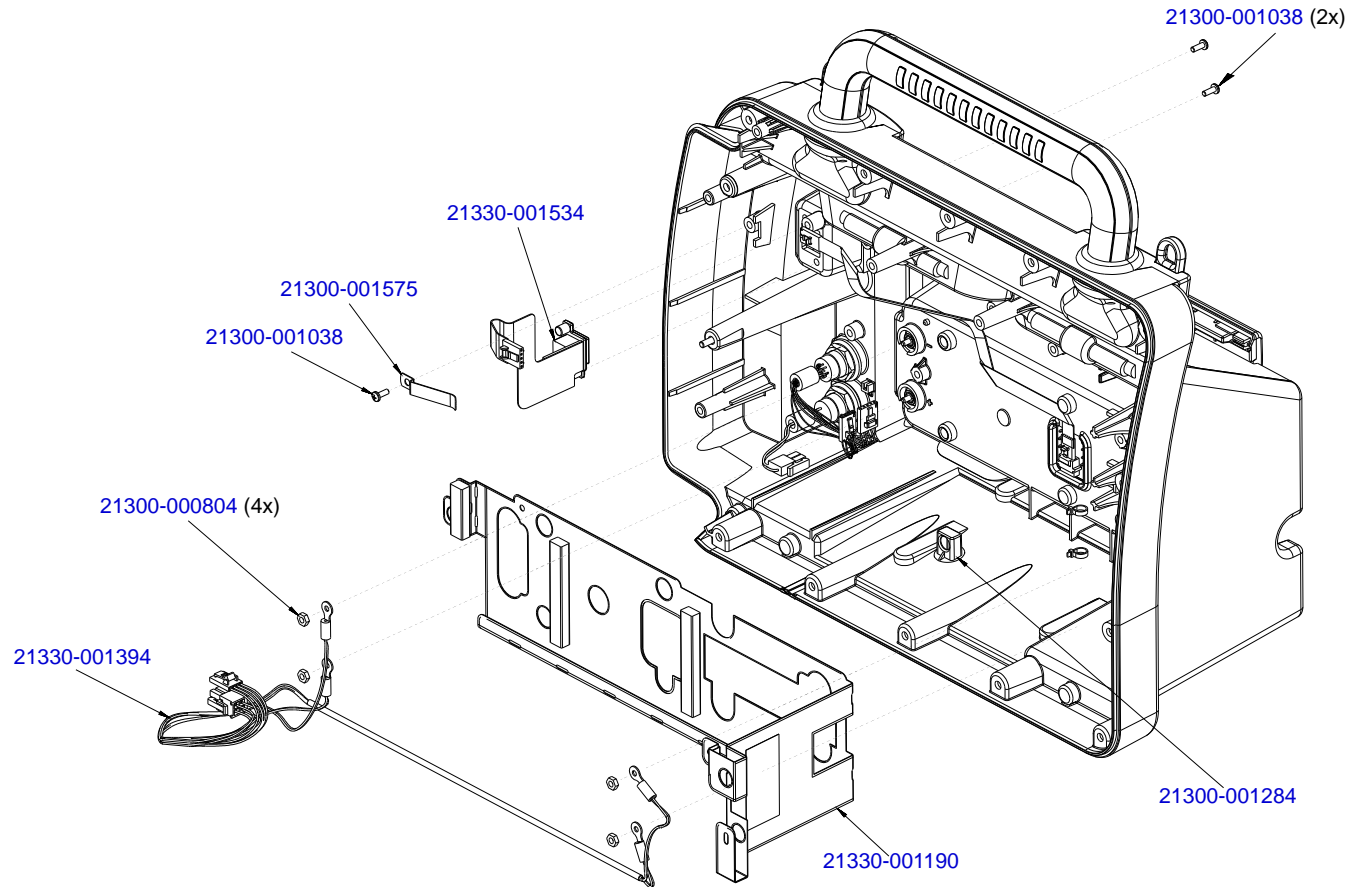

Figure 9.17—Rear Case view 3 of 6

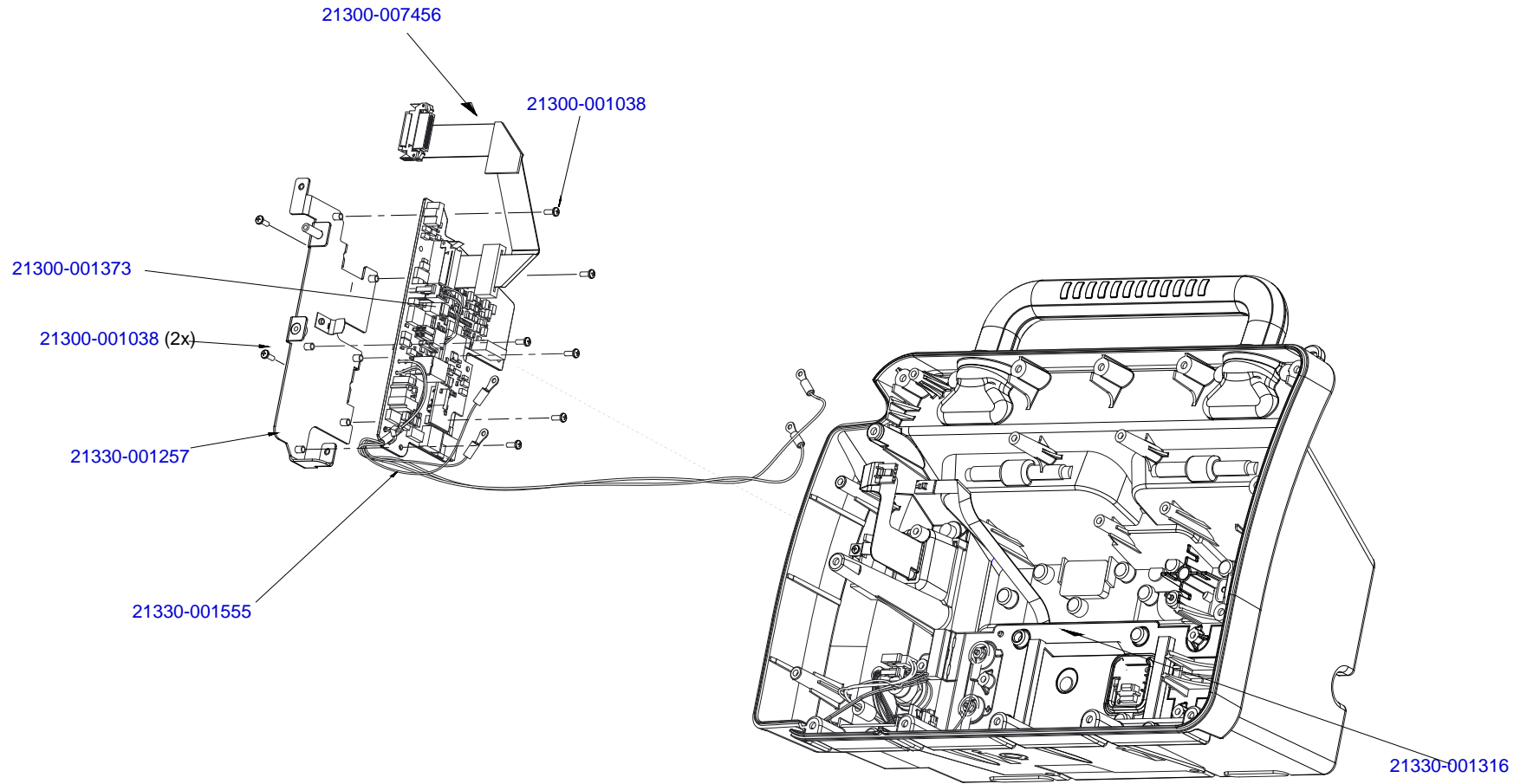

Figure 9.18—Rear Case view 4 of 6

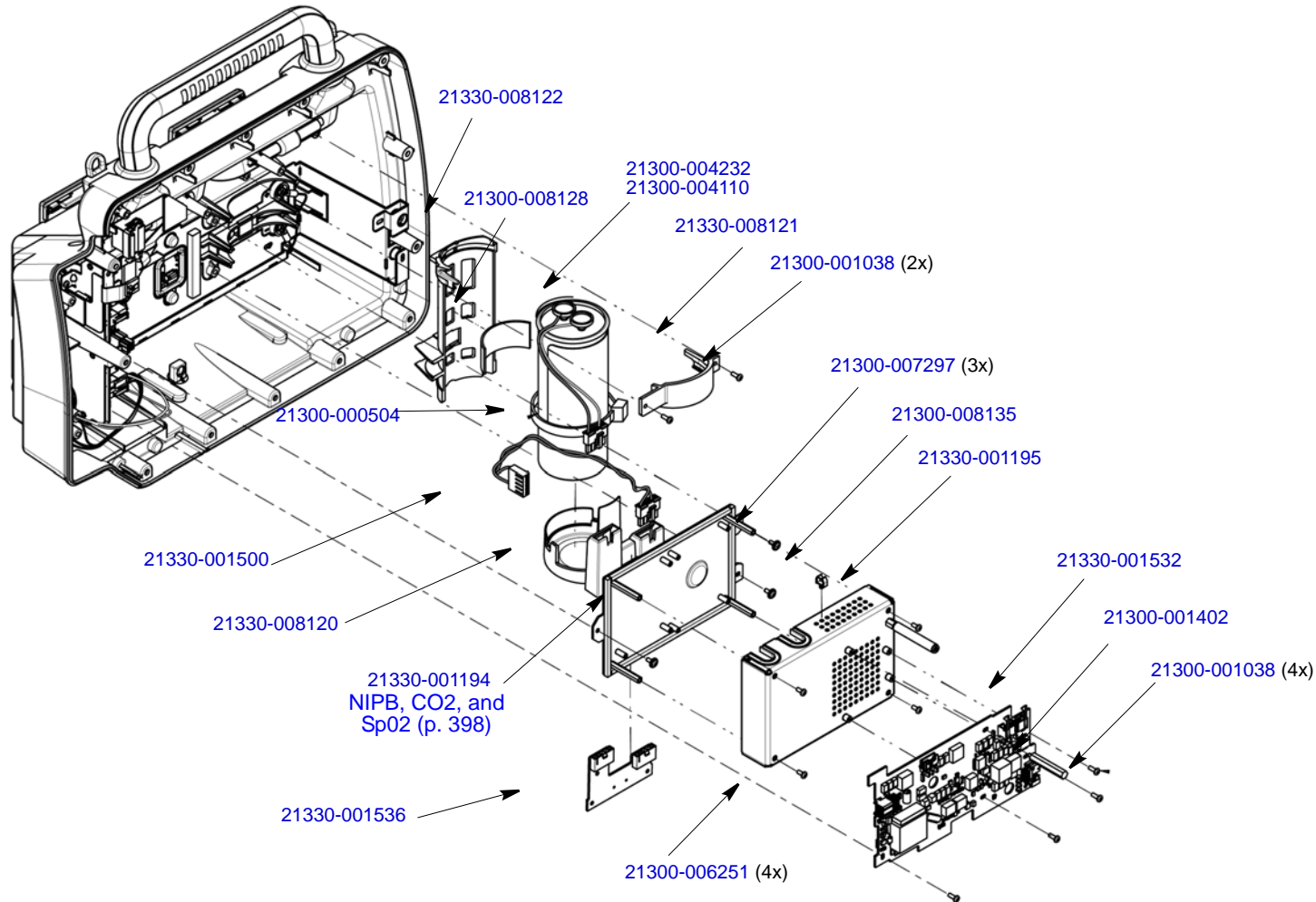

Figure 9.19—Rear Case view 5 of 6

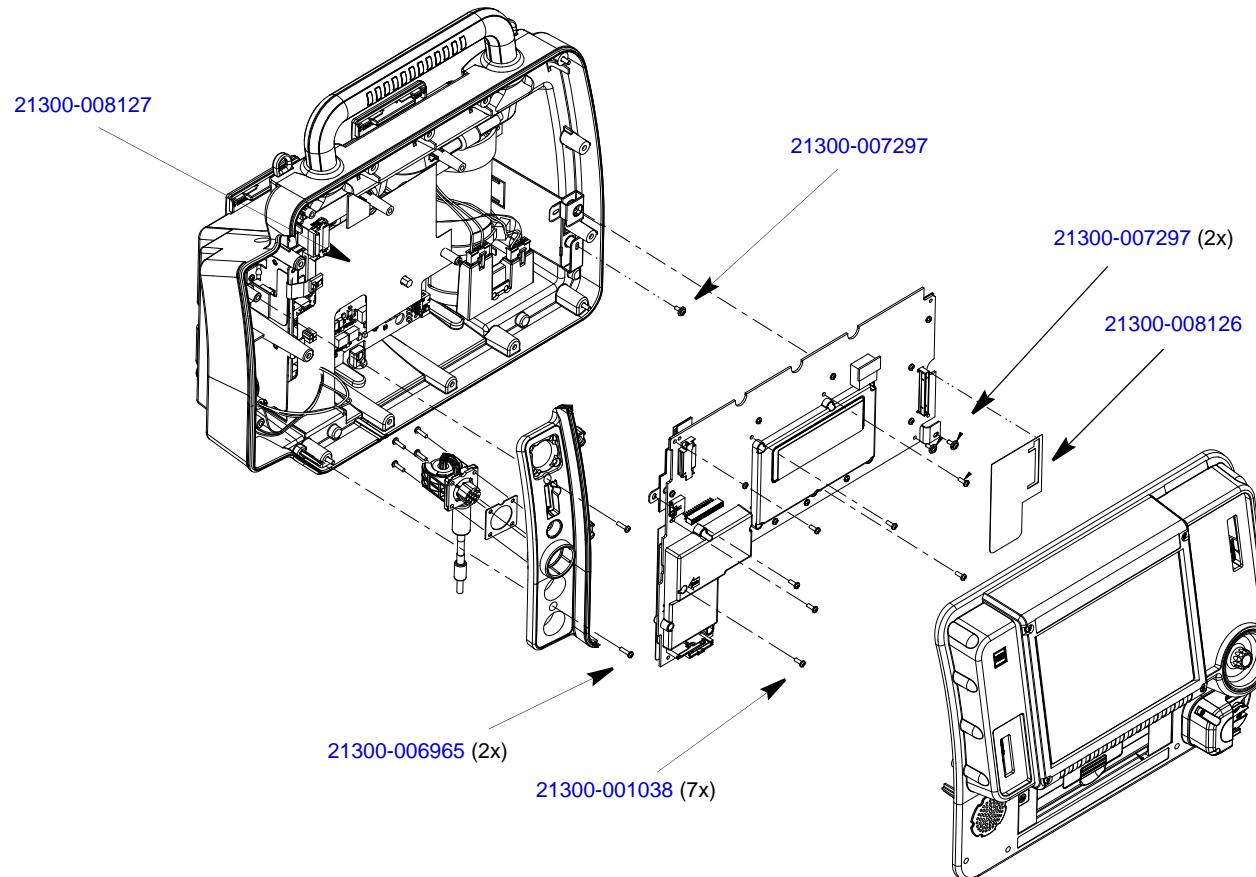

Figure 9.20—Rear Case view 6 of 6

### Rear Parts List

Table 9.7—Rear Parts

CAT.	Qty.	Description	Notes
21330-001555	1	A03 - PCB ASSY - POWER	Refer to <a href="#">Figure 9.18: Rear Case view 4 of 6, p. 390.</a> See also <a href="#">Figure 9.23 (p. 434)</a> for connection diagram.
21330-001532	1	A06 - PCB ASSY - OEM, LP15	Refer to <a href="#">Figure 9.19: Rear Case view 5 of 6, p. 391.</a> See also <a href="#">Figure 9.26 (p. 437)</a> for connection diagram.
21330-001288	1	A07 - CONTACT ASSY - BATTERY	Refer to <a href="#">Figure 9.15: Rear Case view 1 of 6, p. 387.</a> See also <a href="#">Figure 9.27 (p. 438)</a> for connection diagram.
21300-004232	1	A15 - CAPACITOR - ENERGY STORAGE, 2.22 IN DIA	Refer to <a href="#">Figure 9.19: Rear Case view 5 of 6, p. 391.</a> See also <a href="#">Figure 9.33 on p. 444.</a>
21330-001272	1	ASSEMBLY - ENCLOSURE, REAR	Refer to <a href="#">Figure 9.17: Rear Case view 3 of 6, p. 389.</a>
21330-001276	1	ASSEMBLY - RETAINER, BATTERY	Refer to <a href="#">Figure 9.15: Rear Case view 1 of 6, p. 387.</a>
21330-001195	1	BRACKET - COVER, OEM MODULES	Refer to <a href="#">Figure 9.19: Rear Case view 5 of 6, p. 391.</a>
21330-001194	1	BRACKET - MOUNTING, OEM MODULES	Refer to <a href="#">Figure 9.19: Rear Case view 5 of 6, p. 391.</a>
21330-001257	1	BRACKET ASSY - POWER PCB	Refer to <a href="#">Figure 9.18: Rear Case view 4 of 6, p. 390.</a>
21300-007472	2	BRACKET - SHOULDER STRAP	Refer to <a href="#">Figure 9.16: Rear Case view 2 of 6, p. 388.</a>
21300-008135	1	CLIP, CO2 WIRE	Refer to <a href="#">Figure 9.19: Rear Case view 5 of 6, p. 391</a>
21300-002023	4	CONN - PLUG, BANANA PIN	Refer to <a href="#">Figure 9.15: Rear Case view 1 of 6, p. 387.</a>

**Table 9.7—Rear Parts (Continued)**

CAT.	Qty.	Description	Notes
21330-001241	2	COVER - LATCH, PADDLE, GRAY (Part of Rear Case Assembly)	Refer to <a href="#">Figure 9.15: Rear Case view 1 of 6</a> , p. 387. Repair kit, <a href="#">Paddle Retainer Repair Kit (REF 40577-000005)</a> (p. 489).
21300-007470	1	COVER PLATE - HANDLE, RIGHT	Refer to <a href="#">Figure 9.16: Rear Case view 2 of 6</a> , p. 388.
21300-007469	1	COVER PLATE - HANDLE, LEFT	Refer to <a href="#">Figure 9.16: Rear Case view 2 of 6</a> , p. 388.
21330-001190	1	GROUND PLANE - FLEXIBLE REAR CASE	Refer to <a href="#">Figure 9.17: Rear Case view 3 of 6</a> , p. 389.
21300-007471	1	HANDLE	Refer to <a href="#">Figure 9.16: Rear Case view 2 of 6</a> , p. 388.
21300-002691	2	NUT - AUX, SYSTEM, CONN, STAINLESS STEEL	Refer to <a href="#">Figure 9.15: Rear Case view 1 of 6</a> , p. 387.
21300-000804	4	NUT-LOCK, CARBON STEEL, KEP, #4-40	Refer to <a href="#">Figure 9.17: Rear Case view 3 of 6</a> , p. 389.
21300-002650	2	PLATE - SEAL, CONNECTOR, REAR	Refer to <a href="#">Figure 9.15: Rear Case view 1 of 6</a> , p. 387.
21300-000504	1	RETNR - CABLE TIE, NYLON, .35W X 21.0 L	Refer to <a href="#">Figure 9.19: Rear Case view 5 of 6</a> , p. 391.
21300-001038	25	SCREW-M, CS, Z, PH, NYLOCK, 4-40 X .312L	Refer to <a href="#">Figure 9.17: Rear Case view 3 of 6</a> , p. 389, <a href="#">Figure 9.18: Rear Case view 4 of 6</a> , p. 390, and <a href="#">Figure 9.19: Rear Case view 5 of 6</a> , p. 391.
21300-006251	4	SCREW-M, PH, NYLOK, CS, 4-40, .250L	Refer to <a href="#">Figure 9.19: Rear Case view 5 of 6</a> , p. 391.
21300-007297	8	SCREW - MACH, PNH, PHH, NYLOCK, 4-40, 0.312L, WSHR, CS, ZN	Refer to <a href="#">Figure 9.19: Rear Case view 5 of 6</a> , p. 391.
21300-000777	14	SCREW, SELF-SEAL, SELF-LOCK, 6-32 X 0.375	Refer to <a href="#">Figure 9.15: Rear Case view 1 of 6</a> , p. 387 and <a href="#">Figure 9.16: Rear Case view 2 of 6</a> , p. 388.



**Table 9.7—Rear Parts (Continued)**

CAT.	Qty.	Description	Notes
21300-006965	2	SCREW, MACHINE, PANHEAD, NYLOK, 4-40 X 0.437	Refer to <a href="#">Figure 9.20: Rear Case view 6 of 6, p. 392.</a>
21300-000203	2	SEAL, O-RING,RUBBER, .551ID	Refer to <a href="#">Figure 9.15: Rear Case view 1 of 6, p. 387.</a>
21300-001284	1	SEAL, DRAIN	Refer to <a href="#">Figure 9.17: Rear Case view 3 of 6, p. 389.</a>
21300-004110	1	SHIELD - DIELECTRIC,CAPACITOR	Refer to <a href="#">Figure 9.19: Rear Case view 5 of 6, p. 391.</a>
21300-008127	1	SHIELD - DIELECTRIC, OEM, POWER	Refer to <a href="#">Figure 9.20: Rear Case view 6 of 6, p. 392</a>
21300-001575	1	SPRING, CLAMP, STAINLES SSTEEL	Refer to <a href="#">Figure 9.17: Rear Case view 3 of 6, p. 389.</a>
21300-001402	1	STANDOFF, HEX, NYLON	Refer to <a href="#">Figure 9.19: Rear Case view 5 of 6, p. 391.</a>
21300-001567	1	STRAP - GROUND, BTE PCB	Refer to <a href="#">Figure 9.19: Rear Case view 5 of 6, p. 391.</a>
21300-007456	1	W01 - CABLE ASSY - POWER, SYSTEM, PCBA	Refer to <a href="#">Figure 9.18: Rear Case view 4 of 6, p. 390.</a> See also <a href="#">Figure 9.38 on p. 449</a> for connection information.
21300-001373	1	W02 - WIRE HARNESS - POWER/THERAPY/PCB	Refer to <a href="#">Figure 9.18: Rear Case view 4 of 6, p. 390.</a>
21330-001316	1	W05 - CABLE ASSEMBLY - CONTACT PCB/POWER PCB	Refer to <a href="#">Figure 9.18: Rear Case view 4 of 6, p. 390.</a> See also <a href="#">Figure 9.42 (p. 453)</a> for connection diagram.
21330-000156	1	W08 - CABLE ASSY - SYSTEM	Refer to <a href="#">Figure 9.15: Rear Case view 1 of 6, p. 387.</a>
21330-001485	1	W09 - CABLE ASSY - AUX PWR	Refer to <a href="#">Figure 9.15: Rear Case view 1 of 6, p. 387.</a>
21330-001394	1	W10 - BATTERY POWER	Refer to <a href="#">Figure 9.17: Rear Case view 3 of 6, p. 389.</a>
21330-001534	1	W14 - FLEX ASSY - USB, ROHS	Refer to <a href="#">Figure 9.17: Rear Case view 3 of 6, p. 389.</a>

**Table 9.7—Rear Parts (Continued)**

CAT.	Qty.	Description	Notes
21330-008120	1	RETAINING END CAP, THERAPY CAPACITOR	Refer to <a href="#">Figure 9.19: Rear Case view 5 of 6</a> , p. 391.
21330-001536	1	A24 - PCB ASSY, CAPACITOR DISCHARGE, LP15 V4	Refer to <a href="#">Figure 9.19: Rear Case view 5 of 6</a> , p. 391.
21330-008122	1	RETAINING BASE - THERAPY CAPACITOR	Refer to <a href="#">Figure 9.19: Rear Case view 5 of 6</a> , p. 391.
21330-008121	1	RETAINING BRACKET - THERAPY CAPACITOR	Refer to <a href="#">Figure 9.19: Rear Case view 5 of 6</a> , p. 391.
21330-001500	1	W24 - WIRE HARNESS, THERAPY CAPACITOR	Refer to <a href="#">Figure 9.19: Rear Case view 5 of 6</a> , p. 391.
21300-008128	1	THERAPY CAPACITOR FOAM PAD	Refer to <a href="#">Figure 9.19: Rear Case view 5 of 6</a> , p. 391.
21300-008126	1	DIELECTRIC SHIELD, SYSTEM PCBA	Refer to <a href="#">Figure 9.20: Rear Case view 6 of 6</a> , p. 392

### OEM Optional Assemblies, Diagrams and Parts Lists

- [NIPB, CO2, and SpO2 \(p. 398\)](#)
- [SpO2 Internal Parts List \(p. 399\)](#)
- [NIBP Parts List \(p. 399\)](#)
- [CO2 Parts List \(p. 400\)](#)

### NIPB, CO2, and SpO2

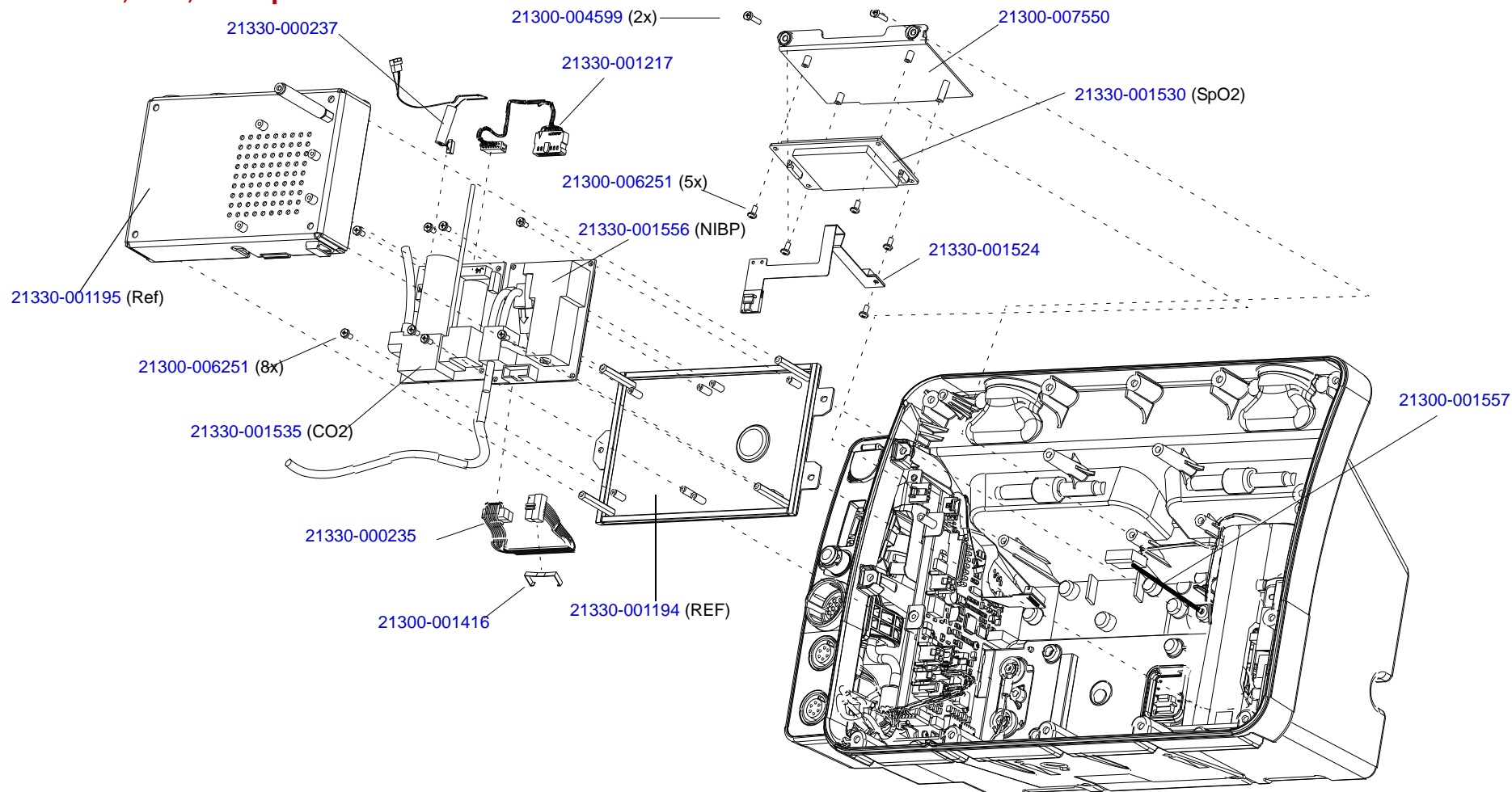

Figure 9.21—NIPB, CO2, and SpO2 view 1 of 1

### SpO2 Internal Parts List

See [Figure 9.21: NIPB, CO2, and SpO2 view 1 of 1, p. 398](#) for the parts listed in this table.

**Table 9.8—SpO2 Catalog Numbers**

CAT.	Qty	Description	Notes
21300-006251	5	SCREW-M, PH, NYLOK, CS, 4-40, .250L	
21300-004599	2	SCREW, MACHINE, PANHEAD, NYLOK, 4-40 X .500	
21300-007550	1	BRACKET - MOUNTING, SpO2 MODULE	
21330-001524	1	W21 - CABLE, ASSY - FLEX, SpO2, OEM, PCB, ROHS	
21330-001530	1	A16 - MODULE - OEM, PULSE OXIMETER, MX-51	

### NIBP Parts List

See [Figure 9.12: Parameter Bezel view 2 of 4 \(optional CO2 and NIBP\), p. 380](#) for NIBP external connector parts.

**Table 9.9—NIBP Catalog Numbers**

CAT.	Qty	Description	Notes
21300-006251	4	SCREW-M, PH, NYLOK, CS, 4-40, .250L	Refer to <a href="#">NIPB, CO2, and SpO2 (p. 398)</a>
21300-001416	1	SOCKET RETAINER CLIP - 10 PIN	Refer to <a href="#">NIPB, CO2, and SpO2 (p. 398)</a>

**Table 9.9—NIBP Catalog Numbers**

CAT.	Qty	Description	Notes
21330-000235	1	W27 - CABLE ASSY-RIBBON, NIBP/OEM PCB	Refer to <a href="#">NIPB, CO2, and SpO2</a> (p. 398). For cable interconnect view, see <a href="#">Figure 9.62</a> (p. 473).
21330-001556	1	A21 MODULE - NIBP, RoHS	Refer to <a href="#">NIPB, CO2, and SpO2</a> (p. 398). For cable interconnect view, see <a href="#">Figure 9.35</a> (p. 446). Repair kit, <a href="#">NIBP Module Repair Kit (REF 40577-000045)</a> (p. 480) or <a href="#">NIBP MAXIQ 5.2 Repair Kit (REF 40577-000036)</a> (p. 481).

### CO2 Parts List

See [Figure 9.12: Parameter Bezel view 2 of 4 \(optional CO2 and NIBP\)](#), p. 380 for CO2 external connector parts.

**Table 9.10—CO2 Catalog Numbers**

CAT.	Qty	Description	Notes
21300-006251	4	SCREW-M, PH, NYLOK, CS, 4-40, .250L	Refer to <a href="#">NIPB, CO2, and SpO2</a> (p. 398).
21300-001557	1	EXHAUST TUBING - CO2	Refer to <a href="#">NIPB, CO2, and SpO2</a> (p. 398).
21330-001535	1	A23 - MODULE, CO2, MINI, MEDI CO2,ROHS	Refer to <a href="#">NIPB, CO2, and SpO2</a> (p. 398). For cable interconnect view, see <a href="#">Figure 9.36</a> (p. 447).
21330-000237	1	W30 - CABLE ASSY - CO2, ADAPTER	Refer to <a href="#">NIPB, CO2, and SpO2</a> (p. 398). For cable interconnect view, see <a href="#">Figure 9.64</a> (p. 475).
21330-001217	1	W26 - CABLE ASSY - CO2 MODULE, OEM PCB	Refer to <a href="#">NIPB, CO2, and SpO2</a> (p. 398). For cable interconnect view, see <a href="#">Figure 9.61</a> (p. 472).

### Label Language Parts

Label language parts include:

- [A09- Printer Control Keypad - Languages \(p. 402\)](#)
- [A10 Main Keypad - Languages \(p. 405\)](#)
- [LIFEPAK 15 Label Set - Languages \(p. 408\)](#)

### A09- Printer Control Keypad - Languages

Table 9.11— A09 Keypad language parts

CAT.	Qty	Part Description
21330-001238	1	Keypad Assy - Printer Control, 12-Lead, English
21330-001264	1	Keypad Assy - Printer Control, English
21330-001326	1	Keypad Assy - Printer Control, 12-Lead, German
21330-001327	1	Keypad Assy - Printer Control, German
21330-001330	1	Keypad Assy - Printer Control, 12-Lead, French
21330-001331	1	Keypad Assy - Printer Control, French
21330-001334	1	Keypad Assy - Printer Control, 12-Lead, Spanish
21330-001335	1	Keypad Assy - Printer Control, Spanish
21330-001328	1	Keypad Assy - Printer Control, 12-Lead, Italian
21330-001329	1	Keypad Assy - Printer Control, Italian
21330-001383	1	Keypad Assy - Printer Control, 12-Lead, Portuguese
21330-001395	1	Keypad Assy - Printer Control, Portuguese
21330-001336	1	Keypad Assy - Printer Control, 12-Lead, Swedish
21330-001337	1	Keypad Assy - Printer Control, Swedish
21330-001338	1	Keypad Assy - Printer Control, 12-Lead, Danish
21330-001339	1	Keypad Assy - Printer Control, Danish





**Table 9.11— A09 Keypad language parts (Continued)**

CAT.	Qty	Part Description
21330-001384	1	Keypad Assy - Printer Control, 12-Lead, Finnish
21330-001402	1	Keypad Assy - Printer Control, Finnish
21330-001340	1	Keypad Assy - Printer Control, 12-Lead, Norwegian
21330-001341	1	Keypad Assy - Printer Control, Norwegian
21330-001332	1	Keypad Assy - Printer Control, 12-Lead, Dutch
21330-001333	1	Keypad Assy - Printer Control, Dutch
21330-001342	1	Keypad Assy - Printer Control, 12-Lead, Polish
21330-001343	1	Keypad Assy - Printer Control, Polish
21330-001385	1	Keypad Assy - Printer Control, 12-Lead, Hungarian
21330-001398	1	Keypad Assy - Printer Control, Hungarian
21330-001386	1	Keypad Assy - Printer Control, 12-Lead, Czech
21330-001401	1	Keypad Assy - Printer Control, Czech
21330-001443	1	Keypad Assy - Printer Control, 12-Lead, Russian
21330-001444	1	Keypad Assy - Printer Control, Russian
21330-001445	1	Keypad Assy - Printer Control, 12-Lead, Korean
21330-001446	1	Keypad Assy - Printer Control, Korean

Table 9.11— A09 Keypad language parts (Continued)

CAT.	Qty	Part Description
21330-001504	1	Keypad Assy - Printer Control, 12-Lead, Japanese
21330-001505	1	Keypad Assy - Printer Control, Japanese

### A10 Main Keypad - Languages

Table 9.12— A10 Keypad language parts

CAT.	Qty	Part Description
21330-001496	1	Keypad Assy - Main Cntrl, CPR, NIBP, English
21330-001497	1	Keypad Assy - Main Cntrl, CPR, English
21330-001450	1	Keypad Assy - Main Cntrl, CPR, NIBP, German
21330-001451	1	Keypad Assy - Main Cntrl, CPR, German
21330-001452	1	Keypad Assy - Main Cntrl, CPR, NIBP, Italian
21330-001453	1	Keypad Assy - Main Cntrl, CPR, Italian
21330-001454	1	Keypad Assy - Main Cntrl, CPR, NIBP, French
21330-001455	1	Keypad Assy - Main Cntrl, CPR, French
21330-001456	1	Keypad Assy - Main Cntrl, CPR, NIBP, Dutch
21330-001457	1	Keypad Assy - Main Cntrl, CPR, Dutch
21330-001458	1	Keypad Assy - Main Cntrl, CPR, NIBP, Spanish
21330-001459	1	Keypad Assy - Main Cntrl, CPR, Spanish
21330-001460	1	Keypad Assy - Main Cntrl, CPR, NIBP, Portuguese
21330-001461	1	Keypad Assy - Main Cntrl, CPR, Portuguese
21330-001462	1	Keypad Assy - Main Cntrl, CPR, NIBP, Brazilian
21330-001463	1	Keypad Assy - Main Cntrl, CPR, Brazilian

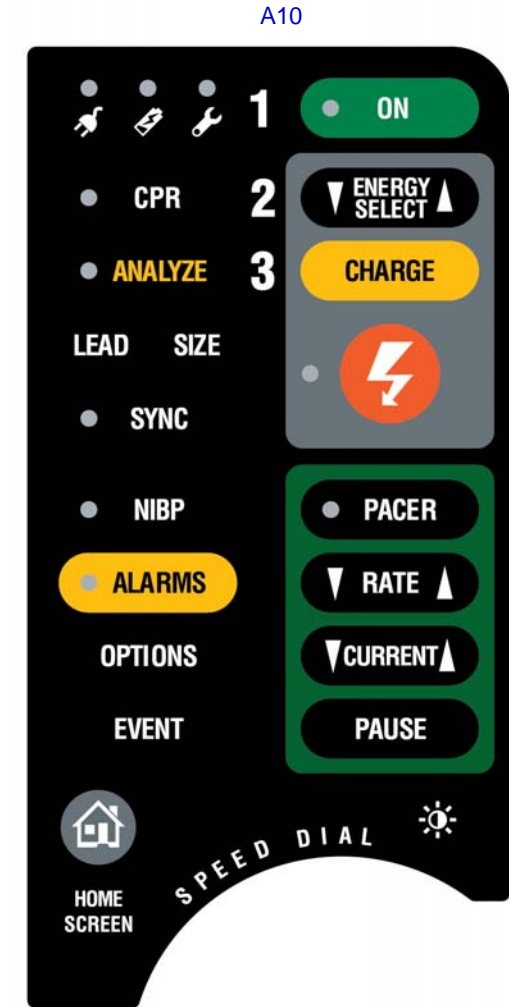

**Table 9.12— A10 Keypad language parts**

CAT.	Qty	Part Description
21330-001464	1	Keypad Assy - Main Cntrl, CPR, NIBP, Swedish
21330-001465	1	Keypad Assy - Main Cntrl, CPR, Swedish
21330-001466	1	Keypad Assy - Main Cntrl, CPR, NIBP, Danish
21330-001469	1	Keypad Assy - Main Cntrl, CPR, Danish
21330-001467	1	Keypad Assy - Main Cntrl, CPR, NIBP, Finnish
21330-001468	1	Keypad Assy - Main Cntrl, CPR, Finnish
21330-001474	1	Keypad Assy - Main Cntrl, CPR, NIBP, Norwegian
21330-001470	1	Keypad Assy - Main Cntrl, CPR, Norwegian
21330-001471	1	Keypad Assy - Main Cntrl, CPR, NIBP, Polish
21330-001472	1	Keypad Assy - Main Cntrl, CPR, Polish
21330-001473	1	Keypad Assy - Main Cntrl, CPR, NIBP, Hungarian
21330-001476	1	Keypad Assy - Main Cntrl, CPR, Hungarian
21330-001475	1	Keypad Assy - Main Cntrl, CPR, NIBP, Czech
21330-001477	1	Keypad Assy - Main Cntrl, CPR, Czech
21330-001478	1	Keypad Assy - Main Cntrl, CPR, NIBP, Russian
21330-001479	1	Keypad Assy - Main Cntrl, CPR, Russian
21330-001480	1	Keypad Assy - Main Cntrl, CPR, NIBP, Korean

Table 9.12— A10 Keypad language parts

CAT.	Qty	Part Description
21330-001481	1	Keypad Assy - Main Cntrl, CPR, Korean
21330-001506	1	Keypad Assy - Main Cntrl, CPR, NIBP, Japanese
21330-001507	1	Keypad Assy - Main Cntrl, CPR, Japanese

### LIFEPAK 15 Label Set - Languages

Table 9.13—Label Set Catalog Numbers

CAT.	Qty	Part Description
21501-002408	1	Label Set – ECG, English
21501-002409	1	Label Set – ECG, SpO2, English
21501-002410	1	Label Set – ECG, NIBP, SpO2, English
21501-002411	1	Label Set – ECG, SpO2, CO2, English
21501-002412	1	Label Set – ECG, SpO2, NIBP, CO2, English
21501-002413	1	Label Set – ECG, SpO2, NIBP, IP, English
21501-002414	1	Label Set – ECG, SpO2, NIBP, CO2, IP, English
21501-002415	1	Label Set – ECG, SpO2, NIBP, CO2, Temp, English
21501-002475	1	Label Set – ECG, German
21501-002476	1	Label Set – ECG, SpO2, German
21501-002477	1	Label Set – ECG, NIBP, SpO2, German
21501-002478	1	Label Set – ECG, SpO2, CO2, German
21501-002479	1	Label Set – ECG, SpO2, NIBP, CO2, German
21501-002545	1	Label Set – ECG, SpO2, NIBP, IP, German
21501-002546	1	Label Set – ECG, SpO2, NIBP, CO2, IP, German
21501-002547	1	Label Set – ECG, SpO2, NIBP, CO2, Temp, German

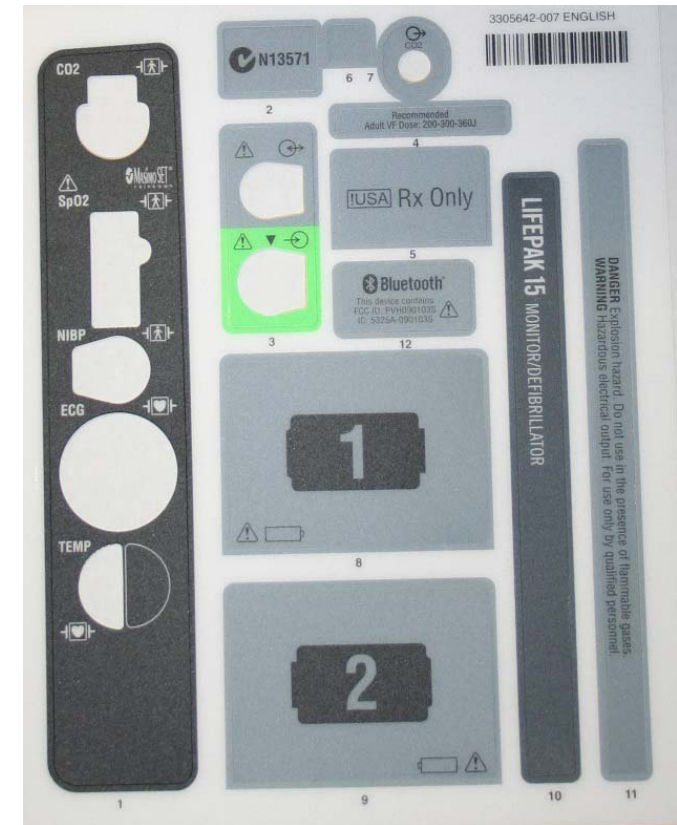

**Table 9.13—Label Set Catalog Numbers (Continued)**

CAT.	Qty	Part Description
21501-002548	1	Label Set – ECG, Italian
21501-002549	1	Label Set – ECG, SpO2, Italian
21501-002550	1	Label Set – ECG, NIBP, SpO2, Italian
21501-002551	1	Label Set – ECG, SpO2, CO2, Italian
21501-002552	1	Label Set – ECG, SpO2, NIBP, CO2, Italian
21501-002553	1	Label Set – ECG, SpO2, NIBP, IP, Italian
21501-002554	1	Label Set – ECG, SpO2, NIBP, CO2, IP, Italian
21501-002555	1	Label Set – ECG, SpO2, NIBP, CO2, Temp, Italian
21501-002480	1	Label Set – ECG, French
21501-002481	1	Label Set – ECG, SpO2, French
21501-002482	1	Label Set – ECG, NIBP, SpO2, French
21501-002483	1	Label Set – ECG, SpO2, CO2, French
21501-002484	1	Label Set – ECG, SpO2, NIBP, CO2, French
21501-002485	1	Label Set – ECG, SpO2, NIBP, IP, French
21501-002486	1	Label Set – ECG, SpO2, NIBP, CO2, IP, French
21501-002487	1	Label Set – ECG, SpO2, NIBP, CO2, Temp, French
21501-002488	1	Label Set – ECG, Dutch

**Table 9.13—Label Set Catalog Numbers (Continued)**

CAT.	Qty	Part Description
21501-002489	1	Label Set – ECG, SpO2, Dutch
21501-002527	1	Label Set – ECG, NIBP, SpO2, Dutch
21501-002528	1	Label Set – ECG, SpO2, CO2, Dutch
21501-002529	1	Label Set – ECG, SpO2, NIBP, CO2, Dutch
21501-002530	1	Label Set – ECG, SpO2, NIBP, IP, Dutch
21501-002536	1	Label Set – ECG, SpO2, NIBP, CO2, IP, Dutch
21501-002500	1	Label Set – ECG, SpO2, NIBP, CO2, Temp, Dutch
21501-002531	1	Label Set – ECG, Spanish
21501-002532	1	Label Set – ECG, SpO2, Spanish
21501-002533	1	Label Set – ECG, NIBP, SpO2, Spanish
21501-002534	1	Label Set – ECG, SpO2, CO2, Spanish
21501-002535	1	Label Set – ECG, SpO2, NIBP, CO2, Spanish
21501-002491	1	Label Set – ECG, SpO2, NIBP, IP, Spanish
21501-002493	1	Label Set – ECG, SpO2, NIBP, CO2, IP, Spanish
21501-002494	1	Label Set – ECG, SpO2, NIBP, CO2, Temp, Spanish
21501-002501	1	Label Set – ECG, Portuguese
21501-002502	1	Label Set – ECG, SpO2, Portuguese



**Table 9.13—Label Set Catalog Numbers (Continued)**

CAT.	Qty	Part Description
21501-002503	1	Label Set – ECG, NIBP, SpO2, Portuguese
21501-002504	1	Label Set – ECG, SpO2, CO2, Portuguese
21501-002505	1	Label Set – ECG, SpO2, NIBP, CO2, Portuguese
21501-002506	1	Label Set – ECG, SpO2, NIBP, IP, Portuguese
21501-002507	1	Label Set – ECG, SpO2, NIBP, CO2, IP, Portuguese
21501-002508	1	Label Set – ECG, SpO2, NIBP, CO2, Temp, Portuguese
21501-002509	1	Label Set – ECG, Brazilian
21501-002557	1	Label Set – ECG, SpO2, Brazilian
21501-002558	1	Label Set – ECG, NIBP, SpO2, Brazilian
21501-002559	1	Label Set – ECG, SpO2, CO2, Brazilian
21501-002560	1	Label Set – ECG, SpO2, NIBP, CO2, Brazilian
21501-002561	1	Label Set – ECG, SpO2, NIBP, IP, Brazilian
21501-002562	1	Label Set – ECG, SpO2, NIBP, CO2, IP, Brazilian
21501-002556	1	Label Set – ECG, SpO2, NIBP, CO2, Temp, Brazilian
21501-002510	1	Label Set – ECG, Swedish
21501-002511	1	Label Set – ECG, SpO2, Swedish
21501-002512	1	Label Set – ECG, NIBP, SpO2, Swedish

**Table 9.13—Label Set Catalog Numbers (Continued)**

CAT.	Qty	Part Description
21501-002513	1	Label Set – ECG, SpO2, CO2, Swedish
21501-002490	1	Label Set – ECG, SpO2, NIBP, CO2, Swedish
21501-002492	1	Label Set – ECG, SpO2, NIBP, IP, Swedish
21501-002495	1	Label Set – ECG, SpO2, NIBP, CO2, IP, Swedish
21501-002496	1	Label Set – ECG, SpO2, NIBP, CO2, Temp, Swedish
21501-002497	1	Label Set – ECG, Danish
21501-002498	1	Label Set – ECG, SpO2, Danish
21501-002499	1	Label Set – ECG, NIBP, SpO2, Danish
21501-002514	1	Label Set – ECG, SpO2, CO2, Danish
21501-002515	1	Label Set – ECG, SpO2, NIBP, CO2, Danish
21501-002516	1	Label Set – ECG, SpO2, NIBP, IP, Danish
21501-002517	1	Label Set – ECG, SpO2, NIBP, CO2, IP, Danish
21501-002518	1	Label Set – ECG, SpO2, NIBP, CO2, Temp, Danish
21501-002519	1	Label Set – ECG, Finnish
21501-002520	1	Label Set – ECG, SpO2, Finnish
21501-002521	1	Label Set – ECG, NIBP, SpO2, Finnish
21501-002522	1	Label Set – ECG, SpO2, CO2, Finnish

**Table 9.13—Label Set Catalog Numbers (Continued)**

CAT.	Qty	Part Description
21501-002523	1	Label Set – ECG, SpO2, NIBP, CO2, Finnish
21501-002524	1	Label Set – ECG, SpO2, NIBP, IP, Finnish
21501-002525	1	Label Set – ECG, SpO2, NIBP, CO2, IP, Finnish
21501-002526	1	Label Set – ECG, SpO2, NIBP, CO2, Temp, Finnish
21501-002537	1	Label Set – ECG, Norwegian
21501-002538	1	Label Set – ECG, SpO2, Norwegian
21501-002540	1	Label Set – ECG, NIBP, SpO2, Norwegian
21501-002539	1	Label Set – ECG, SpO2, CO2, Norwegian
21501-002541	1	Label Set – ECG, SpO2, NIBP, CO2, Norwegian
21501-002542	1	Label Set – ECG, SpO2, NIBP, IP, Norwegian
21501-002543	1	Label Set – ECG, SpO2, NIBP, CO2, IP, Norwegian
21501-002544	1	Label Set – ECG, SpO2, NIBP, CO2, Temp, Norwegian
21501-002563	1	Label Set – ECG, Polish
21501-002564	1	Label Set – ECG, SpO2, Polish
21501-002565	1	Label Set – ECG, NIBP, SpO2, Polish
21501-002566	1	Label Set – ECG, SpO2, CO2, Polish
21501-002567	1	Label Set – ECG, SpO2, NIBP, CO2, Polish

**Table 9.13—Label Set Catalog Numbers (Continued)**

CAT.	Qty	Part Description
21501-002568	1	Label Set – ECG, SpO2, NIBP, IP, Polish
21501-002569	1	Label Set – ECG, SpO2, NIBP, CO2, IP, Polish
21501-002570	1	Label Set – ECG, SpO2, NIBP, CO2, Temp, Polish
21501-002571	1	Label Set – ECG, Hungarian
21501-002572	1	Label Set – ECG, SpO2, Hungarian
21501-002573	1	Label Set – ECG, NIBP, SpO2, Hungarian
21501-002574	1	Label Set – ECG, SpO2, CO2, Hungarian
21501-002575	1	Label Set – ECG, SpO2, NIBP, CO2, Hungarian
21501-002576	1	Label Set – ECG, SpO2, NIBP, IP, Hungarian
21501-002577	1	Label Set – ECG, SpO2, NIBP, CO2, IP, Hungarian
21501-002578	1	Label Set – ECG, SpO2, NIBP, CO2, Temp, Hungarian
21501-002579	1	Label Set – ECG, Czech
21501-002580	1	Label Set – ECG, SpO2, Czech
21501-002581	1	Label Set – ECG, NIBP, SpO2, Czech
21501-002582	1	Label Set – ECG, SpO2, CO2, Czech
21501-002583	1	Label Set – ECG, SpO2, NIBP, CO2, Czech
21501-002584	1	Label Set – ECG, SpO2, NIBP, IP, Czech

**Table 9.13—Label Set Catalog Numbers (Continued)**

CAT.	Qty	Part Description
21501-002585	1	Label Set – ECG, SpO2, NIBP, CO2, IP, Czech
21501-002586	1	Label Set – ECG, SpO2, NIBP, CO2, Temp, Czech
21501-002587	1	Label Set – ECG, Russian
21501-002588	1	Label Set – ECG, SpO2, Russian
21501-002589	1	Label Set – ECG, NIBP, SpO2, Russian
21501-002590	1	Label Set – ECG, SpO2, CO2, Russian
21501-002591	1	Label Set – ECG, SpO2, NIBP, CO2, Russian
21501-002592	1	Label Set – ECG, SpO2, NIBP, IP, Russian
21501-002593	1	Label Set – ECG, SpO2, NIBP, CO2, IP, Russian
21501-002594	1	Label Set – ECG, SpO2, NIBP, CO2, Temp, Russian
21501-002595	1	Label Set – ECG, Korean
21501-002596	1	Label Set – ECG, SpO2, Korean
21501-002597	1	Label Set – ECG, NIBP, SpO2, Korean
21501-002598	1	Label Set – ECG, SpO2, CO2, Korean
21501-002599	1	Label Set – ECG, SpO2, NIBP, CO2, Korean
21501-002600	1	Label Set – ECG, SpO2, NIBP, IP, Korean
21501-002601	1	Label Set – ECG, SpO2, NIBP, CO2, IP, Korean

Table 9.13—Label Set Catalog Numbers (Continued)

CAT.	Qty	Part Description
21501-002602	1	Label Set – ECG, SpO2, NIBP, CO2, Temp, Korean
21501-002649	1	Label Set – ECG, Japanese
21501-002650	1	Label Set – ECG, SpO2, Japanese
21501-002651	1	Label Set – ECG, NIBP, SpO2, Japanese
21501-002652	1	Label Set – ECG, SpO2, CO2, Japanese
21501-002653	1	Label Set – ECG, SpO2, NIBP, CO2, Japanese
21501-002654	1	Label Set – ECG, SpO2, NIBP, IP, Japanese
21501-002655	1	Label Set – ECG, SpO2, NIBP, CO2, IP, Japanese
21501-002656	1	Label Set – ECG, SpO2, NIBP, CO2, Temp, Japanese

### LIFEPAK 15 3<sup>rd</sup> Edition Label Set - Languages

It is acceptable to use enclosure parts that include 3rd edition symbols for repairing 2nd edition products under the following circumstances.

- All parts with symbols specific to 3rd edition must be replaced. Mixed symbols are not allowed.
- A 3rd edition operator instruction manual which defines the 3rd edition symbols must be provided.
- It is also acceptable to use enclosure parts that include 2nd edition symbols for repairing 2nd edition products, if available.

**Table 9.14—3rd Edition Label Set Catalog Numbers**

CAT.	Qty	Part Description
21501-002700	1	Label Set - ECG, English, 3rd Edition
21501-002701	1	Label Set – ECG, SpO2, English, 3 <sup>rd</sup> Edition
21501-002702	1	Label Set – ECG, NIBP, SpO2, English, 3 <sup>rd</sup> Edition
21501-002703	1	Label Set – ECG, SpO2, CO2, English, 3 <sup>rd</sup> Edition
21501-002704	1	Label Set – ECG, SpO2, NIBP, CO2, English, 3 <sup>rd</sup> Edition
21501-002705	1	Label Set – ECG, SpO2, NIBP, IP, English, 3 <sup>rd</sup> Edition
21501-002706	1	Label Set – ECG, SpO2, NIBP, CO2, IP, English, 3 <sup>rd</sup> Edition

**Table 9.14—3rd Edition Label Set Catalog Numbers**

CAT.	Qty	Part Description
21501-002707	1	Label Set – ECG, SpO2, NIBP, CO2, Temp, English, 3 <sup>rd</sup> Edition
21501-002708	1	Label Set – ECG, German, 3 <sup>rd</sup> Edition
21501-002709	1	Label Set – ECG, SpO2, German, 3 <sup>rd</sup> Edition
21501-002710	1	Label Set – ECG, NIBP, SpO2, German, 3 <sup>rd</sup> Edition
21501-002711	1	Label Set – ECG, SpO2, CO2, German, 3 <sup>rd</sup> Edition
21501-002712	1	Label Set – ECG, SpO2, NIBP, CO2, German, 3 <sup>rd</sup> Edition
21501-002713	1	Label Set - ECG, SpO2, NIBP, CO2,IP,English,3 <sup>rd</sup> Edition
21501-002714	1	Label Set - ECG, SpO2,NIBP,CO2,TEMP,English, 3 <sup>rd</sup> Edition
21501-002715	1	Label Set - ECG, SpO2, NIBP, CO2, Temp, German, 3 <sup>rd</sup> Edition
21501-002716	1	Label Set – ECG, Italian, 3 <sup>rd</sup> Edition
21501-002717	1	Label Set – ECG, SpO2, Italian, 3 <sup>rd</sup> Edition
21501-002718	1	Label Set – ECG, NIBP, SpO2, Italian, 3 <sup>rd</sup> Edition



**Table 9.14—3rd Edition Label Set Catalog Numbers**

CAT.	Qty	Part Description
21501-002719	1	Label Set – ECG, SpO2, CO2, Italian, 3 <sup>rd</sup> Edition
21501-002720	1	Label Set – ECG, SpO2, NIBP, CO2, Italian, 3 <sup>rd</sup> Edition
21501-002721	1	Label Set – ECG, SpO2, NIBP, IP, Italian, 3 <sup>rd</sup> Edition
21501-002722	1	Label Set – ECG, SpO2, NIBP, CO2, IP, Italian, 3 <sup>rd</sup> Edition
21501-002723	1	Label Set – ECG, SpO2, NIBP, CO2, Temp, Italian, 3 <sup>rd</sup> Edition
21501-002724	1	Label Set – ECG, French, 3 <sup>rd</sup> Edition
21501-002725	1	Label Set – ECG, SpO2, French, 3 <sup>rd</sup> Edition
21501-002726	1	Label Set – ECG, NIBP, SpO2, French, 3 <sup>rd</sup> Edition
21501-002727	1	Label Set – ECG, SpO2, CO2, French, 3 <sup>rd</sup> Edition
21501-002728	1	Label Set – ECG, SpO2, NIBP, CO2, French, 3 <sup>rd</sup> Edition
21501-002729	1	Label Set - ECG, SpO2, NIBP, IP, French, 3 <sup>rd</sup> Edition

**Table 9.14—3rd Edition Label Set Catalog Numbers**

CAT.	Qty	Part Description
21501-002730	1	Label Set – ECG, SpO2, NIBP, CO2, IP, French, 3 <sup>rd</sup> Edition
21501-002731	1	Label Set – ECG, SpO2, NIBP, CO2, Temp, French, 3 <sup>rd</sup> Edition
21501-002732	1	Label Set – ECG, Dutch, 3 <sup>rd</sup> Edition
21501-002733	1	Label Set – ECG, SpO2, Dutch, 3 <sup>rd</sup> Edition
21501-002734	1	Label Set – ECG, NIBP, SpO2, Dutch, 3 <sup>rd</sup> Edition
21501-002735	1	Label Set – ECG, SpO2, CO2, Dutch, 3 <sup>rd</sup> Edition
21501-002736	1	Label Set – ECG, SpO2, NIBP, CO2, Dutch, 3 <sup>rd</sup> Edition
21501-002737	1	Label Set – ECG, SpO2, NIBP, IP, Dutch, 3 <sup>rd</sup> Edition
21501-002738	1	Label Set – ECG, SpO2, NIBP, CO2, IP, Dutch, 3 <sup>rd</sup> Edition
21501-002739	1	Label Set – ECG, SpO2, NIBP, CO2, Temp, Dutch, 3 <sup>rd</sup> Edition
21501-002740	1	Label Set – ECG, Spanish, 3 <sup>rd</sup> Edition
21501-002741	1	Label Set – ECG, SpO2, Spanish, 3 <sup>rd</sup> Edition

**Table 9.14—3rd Edition Label Set Catalog Numbers**

CAT.	Qty	Part Description
21501-002742	1	Label Set – ECG, NIBP, SpO2, Spanish, 3 <sup>rd</sup> Edition
21501-002743	1	Label Set – ECG, SpO2, CO2, Spanish, 3 <sup>rd</sup> Edition
21501-002744	1	Label Set – ECG, SpO2, NIBP, CO2, Spanish, 3 <sup>rd</sup> Edition
21501-002745	1	Label Set - ECG, SpO2, NIBP, IP, Spanish, 3 <sup>rd</sup> Edition
21501-002746	1	Label Set - ECG, SpO2, NIBP, CO2, IP, Spanish, 3 <sup>rd</sup> Edition
21501-002747	1	Label Set – ECG, SpO2, NIBP, CO2, Temp, Spanish, 3 <sup>rd</sup> Edition
21501-002748	1	Label Set – ECG, Portuguese, 3 <sup>rd</sup> Edition
21501-002749	1	Label Set – ECG, SpO2, Portuguese, 3 <sup>rd</sup> Edition
21501-002750	1	Label Set – ECG, NIBP, SpO2, Portuguese, 3 <sup>rd</sup> Edition
21501-002751	1	Label Set – ECG, SpO2, CO2, Portuguese, 3 <sup>rd</sup> Edition
21501-002752	1	Label Set – ECG, SpO2, NIBP, CO2, Portuguese, 3 <sup>rd</sup> Edition

**Table 9.14—3rd Edition Label Set Catalog Numbers**

CAT.	Qty	Part Description
21501-002753	1	Label Set – ECG, SpO2, NIBP, IP, Portuguese, 3 <sup>rd</sup> Edition
21501-002754	1	Label Set – ECG, SpO2, NIBP, CO2, IP, Portuguese, 3 <sup>rd</sup> Edition
21501-002755	1	Label Set – ECG, SpO2, NIBP, CO2, Temp, Portuguese, 3 <sup>rd</sup> Edition
21501-002756	1	Label Set – ECG, Brazilian, 3 <sup>rd</sup> Edition
21501-002757	1	Label Set – ECG, SpO2, Brazilian, 3 <sup>rd</sup> Edition
21501-002758	1	Label Set – ECG, NIBP, SpO2, Brazilian, 3 <sup>rd</sup> Edition
21501-002759	1	Label Set – ECG, SpO2, CO2, Brazilian, 3 <sup>rd</sup> Edition
21501-002760	1	Label Set - ECG, SpO2, NIBP,IP, Brazilian, 3 <sup>rd</sup> Edition
21501-002761	1	Label Set - ECG, SpO2, NIBP, CO2, IP, Brazilian, 3 <sup>rd</sup> Edition
21501-002762	1	Label Set - ECG, SpO2, NIBP, CO2, IP, Brazilian, 3 <sup>rd</sup> Edition
21501-002763	1	Label Set – ECG, SpO2, NIBP, CO2, Temp, Brazilian, 3 <sup>rd</sup> Edition

**Table 9.14—3rd Edition Label Set Catalog Numbers**

CAT.	Qty	Part Description
21501-002764	1	Label Set – ECG, Swedish, 3 <sup>rd</sup> Edition
21501-002765	1	Label Set – ECG, SpO2, Swedish, 3 <sup>rd</sup> Edition
21501-002766	1	Label Set – ECG, NIBP, SpO2, Swedish, 3 <sup>rd</sup> Edition
21501-002767	1	Label Set – ECG, SpO2, CO2, Swedish, 3 <sup>rd</sup> Edition
21501-002768	1	Label Set – ECG, SpO2, NIBP, CO2, Swedish, 3 <sup>rd</sup> Edition
21501-002769	1	Label Set – ECG, SpO2, NIBP, IP, Swedish, 3 <sup>rd</sup> Edition
21501-002770	1	Label Set – ECG, SpO2, NIBP, CO2, IP, Swedish, 3 <sup>rd</sup> Edition
21501-002771	1	Label Set – ECG, SpO2, NIBP, CO2, Temp, Swedish, 3 <sup>rd</sup> Edition
21501-002772	1	Label Set – ECG, Danish, 3 <sup>rd</sup> Edition
21501-002773	1	Label Set – ECG, SpO2, Danish, 3 <sup>rd</sup> Edition
21501-002774	1	Label Set – ECG, NIBP, SpO2, Danish, 3 <sup>rd</sup> Edition
21501-002775	1	Label Set– ECG,SpO2,CO2,Danish, 3 <sup>rd</sup> Edition

**Table 9.14—3rd Edition Label Set Catalog Numbers**

CAT.	Qty	Part Description
21501-002776	1	Label Set – ECG, SpO2, NIBP, CO2, Danish, 3 <sup>rd</sup> Edition
21501-002777	1	Label Set – ECG, SpO2, NIBP, IP, Danish 3 <sup>rd</sup> Edition
21501-002778	1	Label Set – ECG, SpO2, NIBP, CO2, IP, Danish, 3 <sup>rd</sup> Edition
21501-002779	1	Label Set – ECG, SpO2, NIBP, CO2, Temp, Danish, 3 <sup>rd</sup> Edition
21501-002780	1	Label Set – ECG, Finnish, 3 <sup>rd</sup> Edition
21501-002781	1	Label Set – ECG, SpO2, Finnish, 3 <sup>rd</sup> Edition
21501-002782	1	Label Set – ECG, NIBP, SpO2, Finnish, 3 <sup>rd</sup> Edition
21501-002783	1	Label Set – ECG, SpO2, CO2, Finnish, 3 <sup>rd</sup> Edition
21501-002784	1	Label Set – ECG, SpO2, NIBP, CO2, Finnish, 3 <sup>rd</sup> Edition
21501-002785	1	Label Set – ECG, SpO2, NIBP, IP, Finnish, 3 <sup>rd</sup> Edition
21501-002786	1	Label Set – ECG, SpO2, NIBP, CO2, IP, Finnish, 3 <sup>rd</sup> Edition

**Table 9.14—3rd Edition Label Set Catalog Numbers**

CAT.	Qty	Part Description
21501-002787	1	Label Set – ECG, SpO2, NIBP, CO2, Temp, Finnish, 3 <sup>rd</sup> Edition
21501-002788	1	Label Set – ECG, Norwegian, 3 <sup>rd</sup> Edition
21501-002789	1	Label Set – ECG, SpO2, Norwegian, 3 <sup>rd</sup> Edition
21501-002790	1	Label Set – ECG, NIBP, SpO2, Norwegian, 3 <sup>rd</sup> Edition
21501-002791	1	Label Set – ECG, SpO2, CO2, Norwegian, 3 <sup>rd</sup> Edition
21501-002792	1	Label Set – ECG, SpO2, NIBP, CO2, Norwegian, 3 <sup>rd</sup> Edition
21501-002793	1	Label Set – ECG, SpO2, NIBP, IP, Norwegian, 3 <sup>rd</sup> Edition
21501-002794	1	Label Set – ECG, SpO2, NIBP, CO2, IP, Norwegian, 3 <sup>rd</sup> Edition
21501-002795	1	Label Set – ECG, SpO2, NIBP, CO2, Temp, Norwegian, 3 <sup>rd</sup> Edition
21501-002796	1	Label Set – ECG, Polish, 3 <sup>rd</sup> Edition
21501-002797	1	Label Set – ECG, SpO2, Polish, 3 <sup>rd</sup> Edition
21501-002798	1	Label Set – ECG, NIBP, SpO2, Polish, 3 <sup>rd</sup> Edition

**Table 9.14—3rd Edition Label Set Catalog Numbers**

CAT.	Qty	Part Description
21501-002799	1	Label Set – ECG, SpO2, CO2, Polish, 3 <sup>rd</sup> Edition
21501-002800	1	Label Set – ECG, SpO2, NIBP, CO2, Polish, 3 <sup>rd</sup> Edition
21501-002801	1	Label Set – ECG, SpO2, NIBP, IP, Polish, 3 <sup>rd</sup> Edition
21501-002802	1	Label Set – ECG, SpO2, NIBP, CO2, IP, Polish, 3 <sup>rd</sup> Edition
21501-002803	1	Label Set – ECG, SpO2, NIBP, CO2, Temp, Polish, 3 <sup>rd</sup> Edition
21501-002804	1	Label Set – ECG, Hungarian, 3 <sup>rd</sup> Edition
21501-002805	1	Label Set – ECG, SpO2, Hungarian, 3 <sup>rd</sup> Edition
21501-002805	1	Label Set – ECG, SpO2, Hungarian, 3 <sup>rd</sup> Edition
21501-002806	1	Label Set – ECG, NIBP, SpO2, Hungarian, 3 <sup>rd</sup> Edition
21501-002807	1	Label Set – ECG, SpO2, CO2, Hungarian, 3 <sup>rd</sup> Edition
21501-002808	1	Label Set – ECG, SpO2, NIBP, CO2, Hungarian, 3 <sup>rd</sup> Edition
21501-002809	1	Label Set – ECG, SpO2, NIBP, IP, Hungarian, 3 <sup>rd</sup> Edition



**Table 9.14—3rd Edition Label Set Catalog Numbers**

CAT.	Qty	Part Description
21501-002810	1	Label Set – ECG, SpO2, NIBP, CO2, IP, Hungarian, 3rd Edition
21501-002811	1	Label Set – ECG, SpO2, NIBP, CO2, Temp, Hungarian, 3 <sup>rd</sup> Edition
21501-002812	1	Label Set - ECG, Czech, 3 <sup>rd</sup> Edition
21501-002813	1	Label Set – ECG, SpO2, Czech, 3 <sup>rd</sup> Edition
21501-002814	1	Label Set – ECG, NIBP, SpO2, Czech, 3 <sup>rd</sup> Edition
21501-002815	1	Label Set – ECG, SpO2, CO2, Czech, 3 <sup>rd</sup> Edition
21501-002816	1	Label Set – ECG, SpO2, NIBP, CO2, Czech, 3 <sup>rd</sup> Edition
21501-002817	1	Label Set – ECG, SpO2, NIBP, IP, Czech, 3 <sup>rd</sup> Edition
21501-002818	1	Label Set – ECG, SpO2, NIBP, CO2, IP, Czech, 3 <sup>rd</sup> Edition
21501-002819	1	Label Set – ECG, SpO2, NIBP, CO2, Temp, Czech, 3 <sup>rd</sup> Edition
21501-002820	1	Label Set – ECG, Russian, 3 <sup>rd</sup> Edition
21501-002821	1	Label Set – ECG, SpO2, Russian, 3 <sup>rd</sup> Edition

**Table 9.14—3rd Edition Label Set Catalog Numbers**

CAT.	Qty	Part Description
21501-002822	1	Label Set – ECG, NIBP, SpO2, Russian, 3 <sup>rd</sup> Edition
21501-002823	1	Label Set – ECG, SpO2, CO2, Russian, 3 <sup>rd</sup> Edition
21501-002824	1	Label Set – ECG, SpO2, NIBP, CO2, Russian, 3 <sup>rd</sup> Edition
21501-002825	1	Label Set – ECG, SpO2, NIBP, IP, Russian, 3 <sup>rd</sup> Edition
21501-002826	1	Label Set – ECG, SpO2, NIBP, CO2, IP, Russian, 3 <sup>rd</sup> Edition
21501-002827	1	Label Set – ECG, SpO2, NIBP, CO2, Temp, Russian, 3 <sup>rd</sup> Edition
21501-002828	1	Label Set – ECG, Korean, 3 <sup>rd</sup> Edition
21501-002829	1	Label Set – ECG, SpO2, Korean, 3 <sup>rd</sup> Edition
21501-002830	1	Label Set – ECG, NIBP, SpO2, Korean, 3 <sup>rd</sup> Edition
21501-002831	1	Label Set – ECG, SpO2, CO2, Korean, 3 <sup>rd</sup> Edition
21501-002832	1	Label Set – ECG, SpO2, NIBP, CO2, Korean, 3 <sup>rd</sup> Edition

**Table 9.14—3rd Edition Label Set Catalog Numbers**

CAT.	Qty	Part Description
21501-002833	1	Label Set – ECG, SpO2, NIBP, IP, Korean, 3 <sup>rd</sup> Edition
21501-002834	1	Label Set – ECG, SpO2, NIBP, CO2, IP, Korean, 3 <sup>rd</sup> Edition
21501-002835	1	Label Set – ECG, SpO2, NIBP, CO2, Temp, Korean, 3rd Edition
21501-002836	1	Label Set – ECG, Japanese, 3rd Edition
21501-002837	1	Label Set – ECG, SpO2, Japanese, 3rd Edition
21501-002838	1	Label Set – ECG, NIBP, SpO2, Japanese, 3rd Edition
21501-002839	1	Label Set – ECG, SpO2, CO2, Japanese, 3rd Edition
21501-002840	1	Label Set – ECG, SpO2, NIBP, CO2, Japanese, 3rd Edition
21501-002841	1	Label Set – ECG, SpO2, NIBP, IP, Japanese, 3 <sup>rd</sup> Edition
21501-002842	1	Label Set – ECG, SpO2, NIBP, CO2, IP, Japanese, 3 <sup>rd</sup> Edition
21501-002843	1	Label Set – ECG, SpO2, NIBP, CO2, Temp, Japanese, 3 <sup>rd</sup> Edition

### LIFEPAK 15 Setup Mode - Instructions

**Table 9.15— Setup Mode - Instruction Catalog Numbers**

CAT.	Qty	Part Description
26500-003308	1	INSTRUCTION,SETUP MODES,LP15,V2,V4,ENGLISH
26500-003309	1	INSTRUCTION,SETUP MODES, LP15,V2,V4,INTL ENGLISH
26500-003310	1	INSTRUCTION,SETUP MODES, LP15,V2,V4,GERMAN
26500-003311	1	INSTRUCTION,SETUP MODES, LP15,V2,V4,ITALIAN
26500-003312	1	INSTRUCTION,SETUP MODES, LP15,V2,V4,FRENCH
26500-003313	1	INSTRUCTION,SETUP MODES, LP15,V2,V4,DUTCH
26500-003314	1	INSTRUCTION,SETUP MODES, LP15,V2,V4,SPANISH
26500-003315	1	INSTRUCTION,SETUP MODES, LP15,V2,V4 I.PORTUGUESE
26500-003316	1	INSTRUCTION,SETUP MODES, LP15,V2,V4,B.PORTUGUESE

**Table 9.15— Setup Mode - Instruction Catalog Numbers**

CAT.	Qty	Part Description
26500-003317	1	INSTRUCTION, SETUP MODES, LP15, V2, V4, SWEDISH
26500-003318	1	INSTRUCTION, SETUP MODES, LP15, V2, V4, DANISH
26500-003319	1	INSTRUCTION, SETUP MODES, LP15, V2, V4, FINNISH
26500-003320	1	INSTRUCTION, SETUP MODES, LP15, V2, V4, NORWEGIAN
26500-003321	1	INSTRUCTION, SETUP MODES, LP15, V2, V4, POLISH
26500-003322	1	INSTRUCTION, SETUP MODES, LP15, V2, V4, HUNGARIAN
26500-003323	1	INSTRUCTION, SETUP MODES, LP15, V2, V4, CZECH
26500-003324	1	INSTRUCTION, SETUP MODES, LP15, V2, V4, RUSSIAN
26500-003325	1	INSTRUCTION, SETUP MODES, LP15, V2, V4, KOREAN
26500-003327	1	INSTRUCTION, SETUP MODES, LP15, INTL. ENGLISH

### Connection Diagrams for Assemblies, Control Boards, Cables, and Connectors

This section included diagrams for the following assemblies and parts:

- Therapy PCB (p. 435)
- Power PCB (p. 434)
- System PCB (p. 433)
- Interface PCB (p. 436)
- OEM PCB Module (p. 437)
- Contact PCB Module (p. 438)
- Backlight PCB (p. 439)
- Printer Control Keypad (p. 440)
- Main Keypad (p. 441)
- LCD Assembly (p. 442)
- Printer Assembly (p. 443)
- Energy Storage Capacitor (p. 444)
- SpO2 Module (p. 445)
- NIBP Module (p. 446)
- CO2 Module (p. 447)
- Power PCB/System PCB Cable (p. 449)
- Power PCB/Therapy PCB Cable (p. 450)
- System PCB/Therapy PCB Connector (p. 451)
- System PCB/Interface PCB Cable (p. 452)
- Power PCB/Contact PCB Cable (p. 453)
- Backlight PCB/Interface PCB Cable (p. 454)
- ECG Connector Cable (p. 455)
- System Connector Cable (p. 456)
- Battery Pins/Power PCB Cable (p. 458)
- Therapy Connector Cable (p. 460)
- Printer Control Keypad/Interface PCB Cable (p. 461)
- Main Keypad/Interface PCB Cable (p. 462)
- USB Flex Assembly (p. 463)
- Printer Assembly/Interface PCB Cable (p. 465)
- Speaker Assembly (p. 466)
- LCD Assembly/Interface PCB Cable (p. 467)
- Printer Assembly/Chassis Ground Cable (p. 468)
- OEM PCB/SpO2 Module Cable (p. 469)
- SpO2 Connector Cable (p. 470)
- OEM PCB/CO2 Module Cable (p. 472)
- OEM PCB/NIBP Module Cable (p. 473)
- OEM PCB/NIBP Module Cable (p. 473)
- CO2 Inlet Connector Cable (p. 474)
- Temperature Connector Cable Assembly (p. 477)

### System PCB

Refer to [System/Therapy PCB Assembly Diagrams and Parts List \(p. 374\)](#) and [Figure 9.10: System/Therapy PCB assembly view 2 of 2, p. 375](#)  
See also REF 21330-001539 in table for parts information.

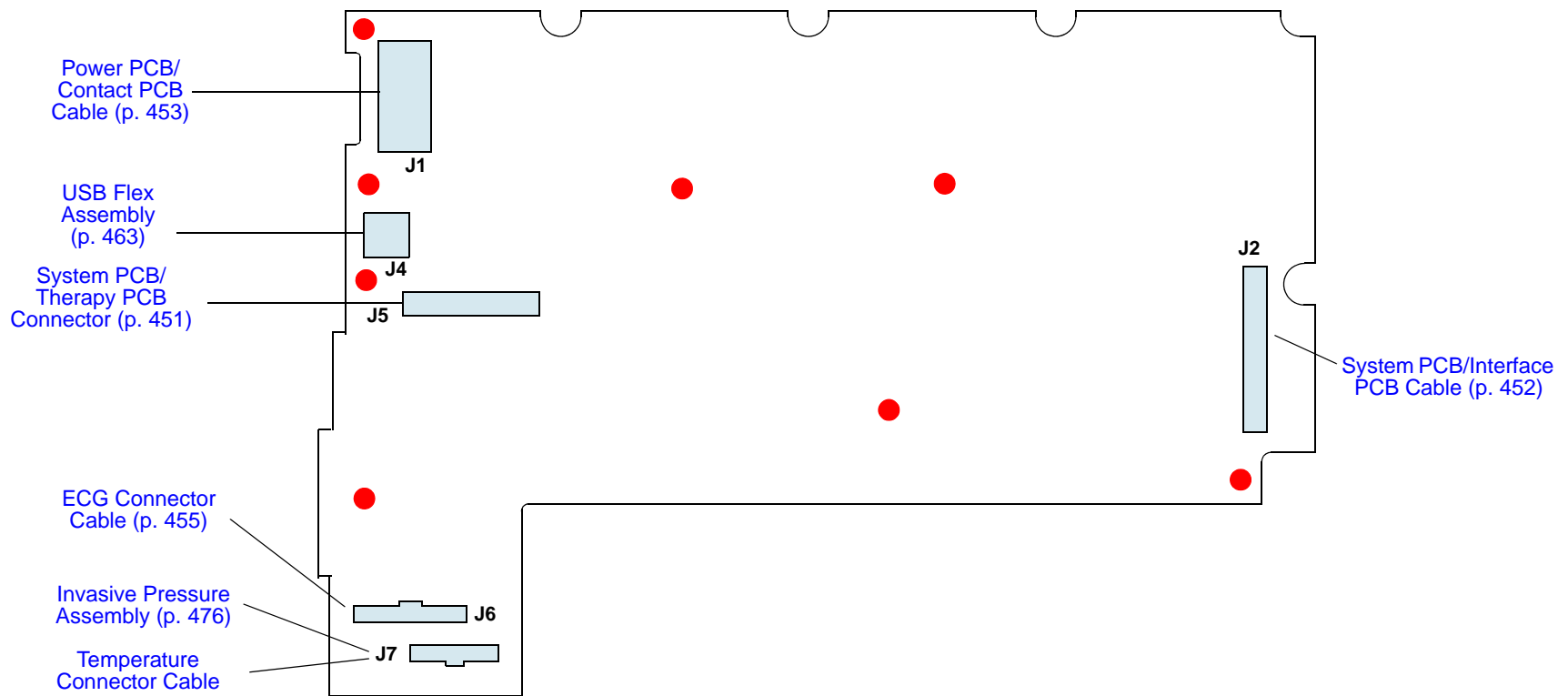

Figure 9.22—Diagram for item A01

### Power PCB

Refer to [Figure 9.18: Rear Case view 4 of 6, p. 390](#).  
See REF [21330-001555](#) in table for parts information.

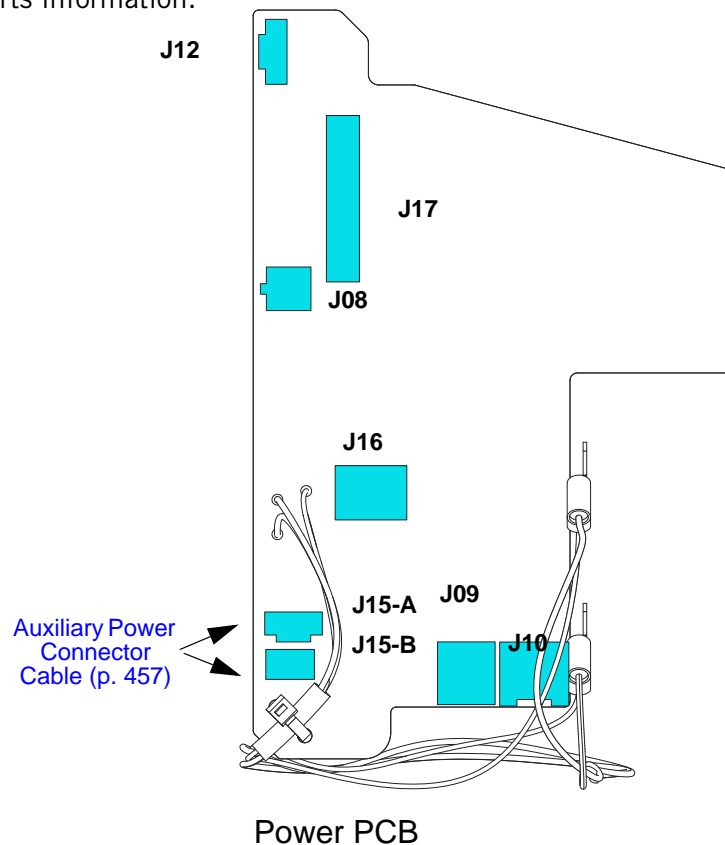

Figure 9.23—Diagram for item A03



### Therapy PCB

Refer to [System/Therapy PCB Assembly Diagrams and Parts List \(p. 374\)](#) and [Figure 9.10: System/Therapy PCB assembly view 2 of 2, p. 375](#)  
See also REF [21330-001538](#) in table for parts information.

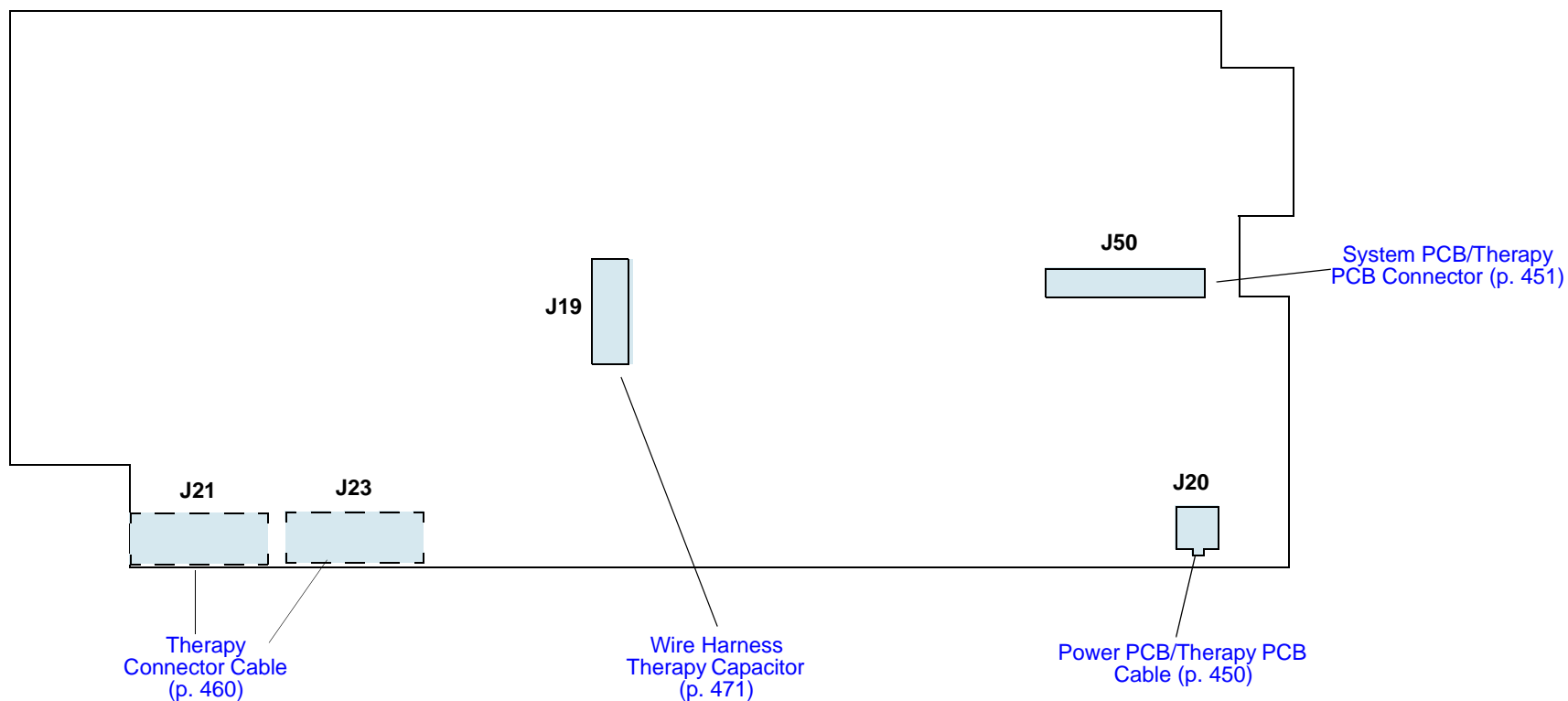

Figure 9.24—Diagram for item A04

### Interface PCB

Refer to [Figure 9.7: Front Case parts view 2 of 3, p. 366.](#)  
See REF [21330-001533](#) in table for parts information.

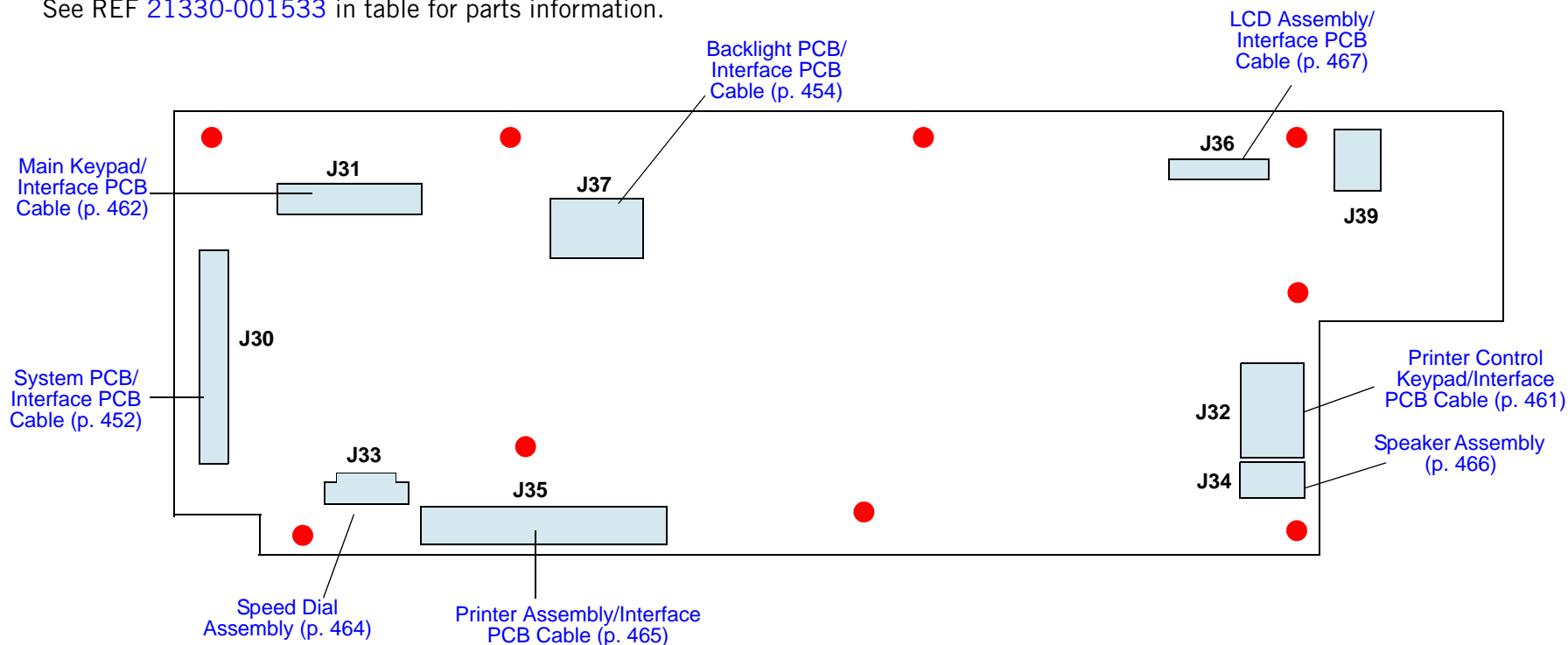

Figure 9.25—Diagram for item A05

### OEM PCB Module

Refer to [Figure 9.19: Rear Case view 5 of 6](#), p. 391.  
See REF [21330-001532](#) in table for parts information.

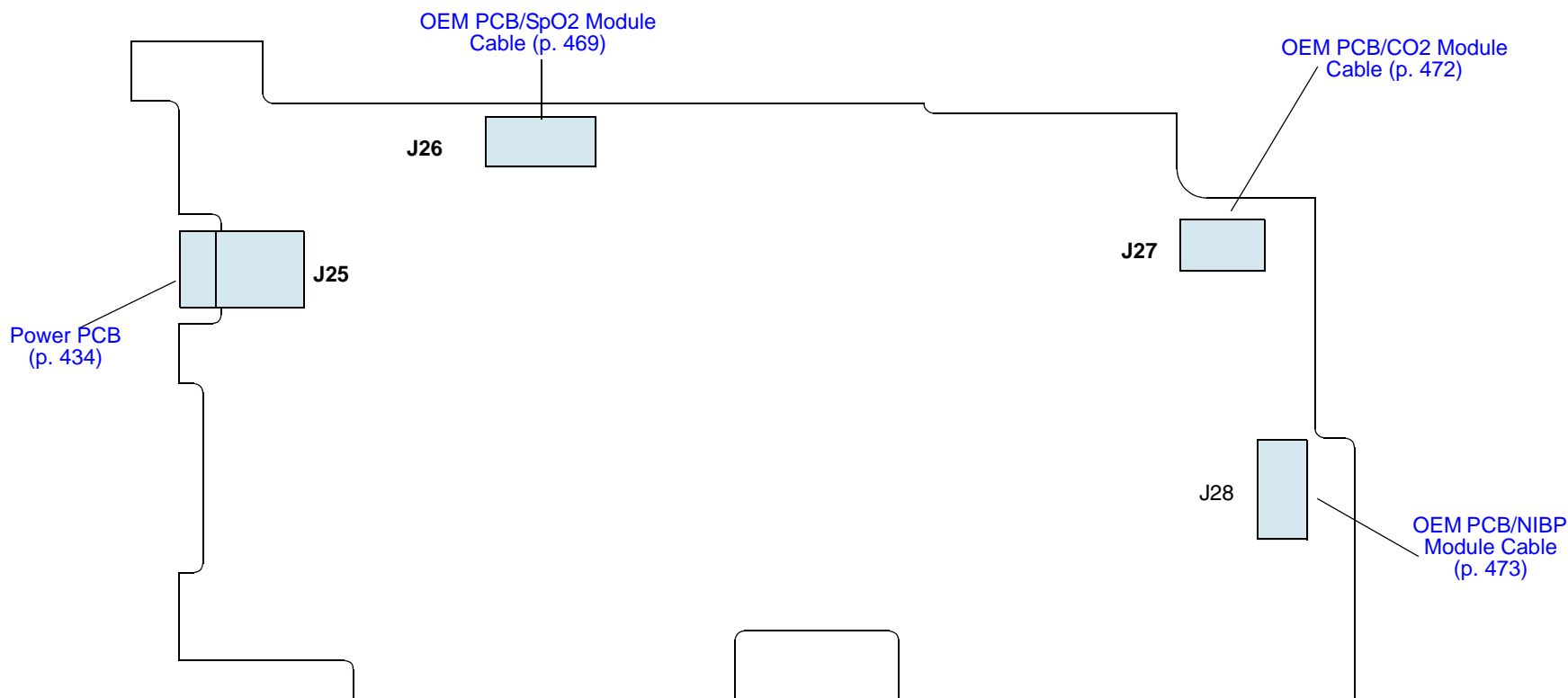

Figure 9.26—Diagram for item A06

### Contact PCB Module

Refer to [Figure 9.15: Rear Case view 1 of 6, p. 387](#).  
See REF [21330-001288](#) in table for parts information.

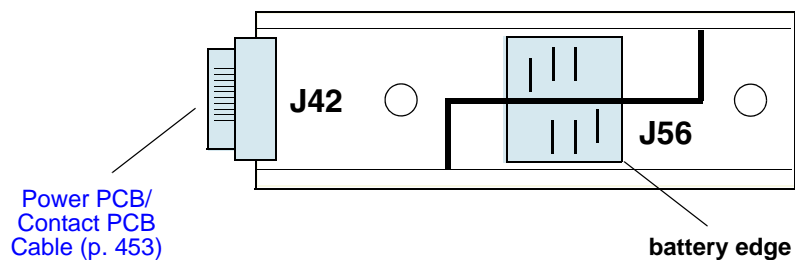

Figure 9.27—Diagram for item A07

### Backlight PCB

Refer to [Figure 9.7: Front Case parts view 2 of 3, p. 366.](#)  
See REF [21300-008138](#) in table for parts information.

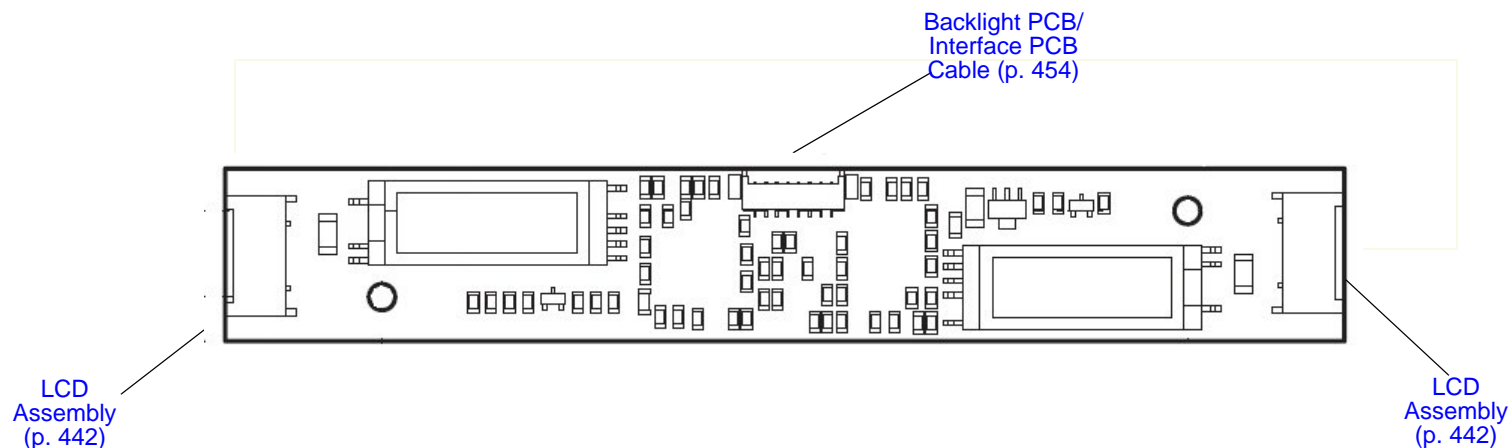

Figure 9.28—Diagram for item A08

### Printer Control Keypad

Refer to [External and Configured Parts Diagram — Page 1 of 2 \(p. 359\)](#).  
See Example: REF 21330-001238 in table for parts information.

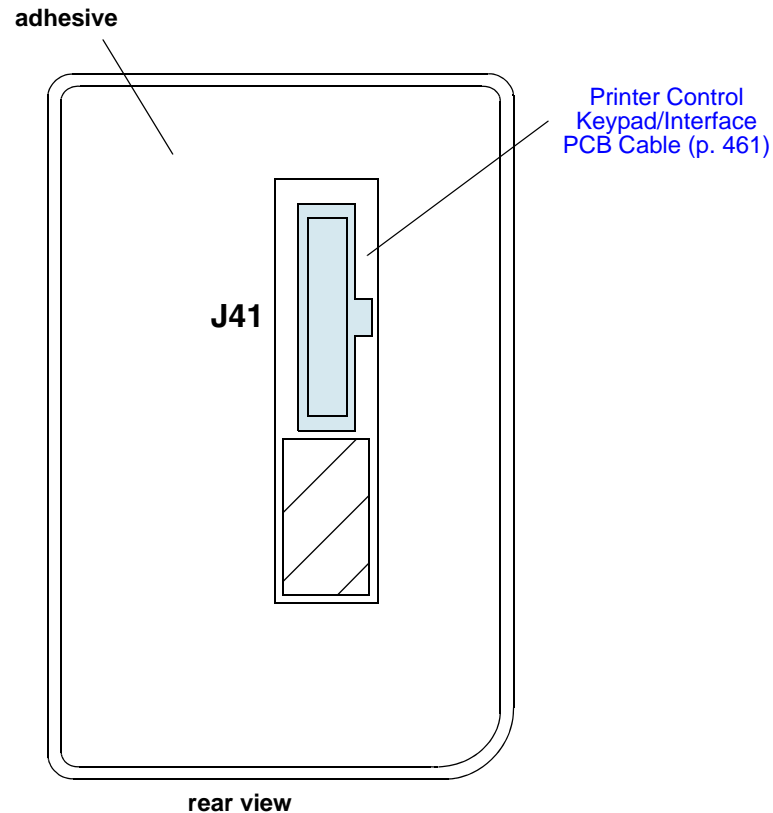

Figure 9.29—Diagram for item A09

### Main Keypad

Refer to [External and Configured Parts Diagram — Page 1 of 2 \(p. 359\)](#).  
See Example: REF [21330-001496](#) in table for parts information.

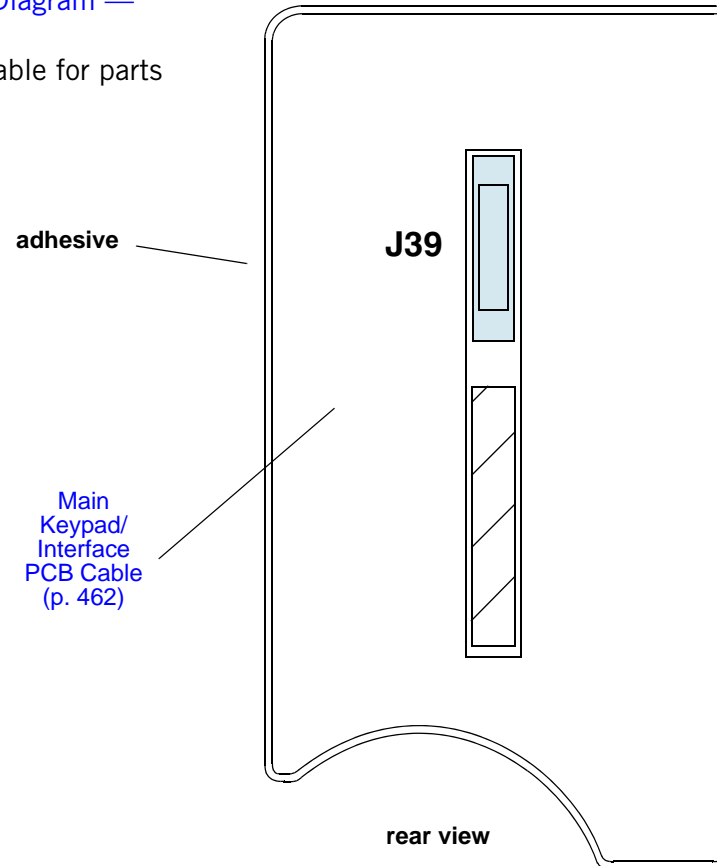

Figure 9.30—Diagram for item A10

### LCD Assembly

Refer to [Figure 9.7: Front Case parts view 2 of 3](#), p. 366.  
See REF [21300-008140](#) in table for parts information.

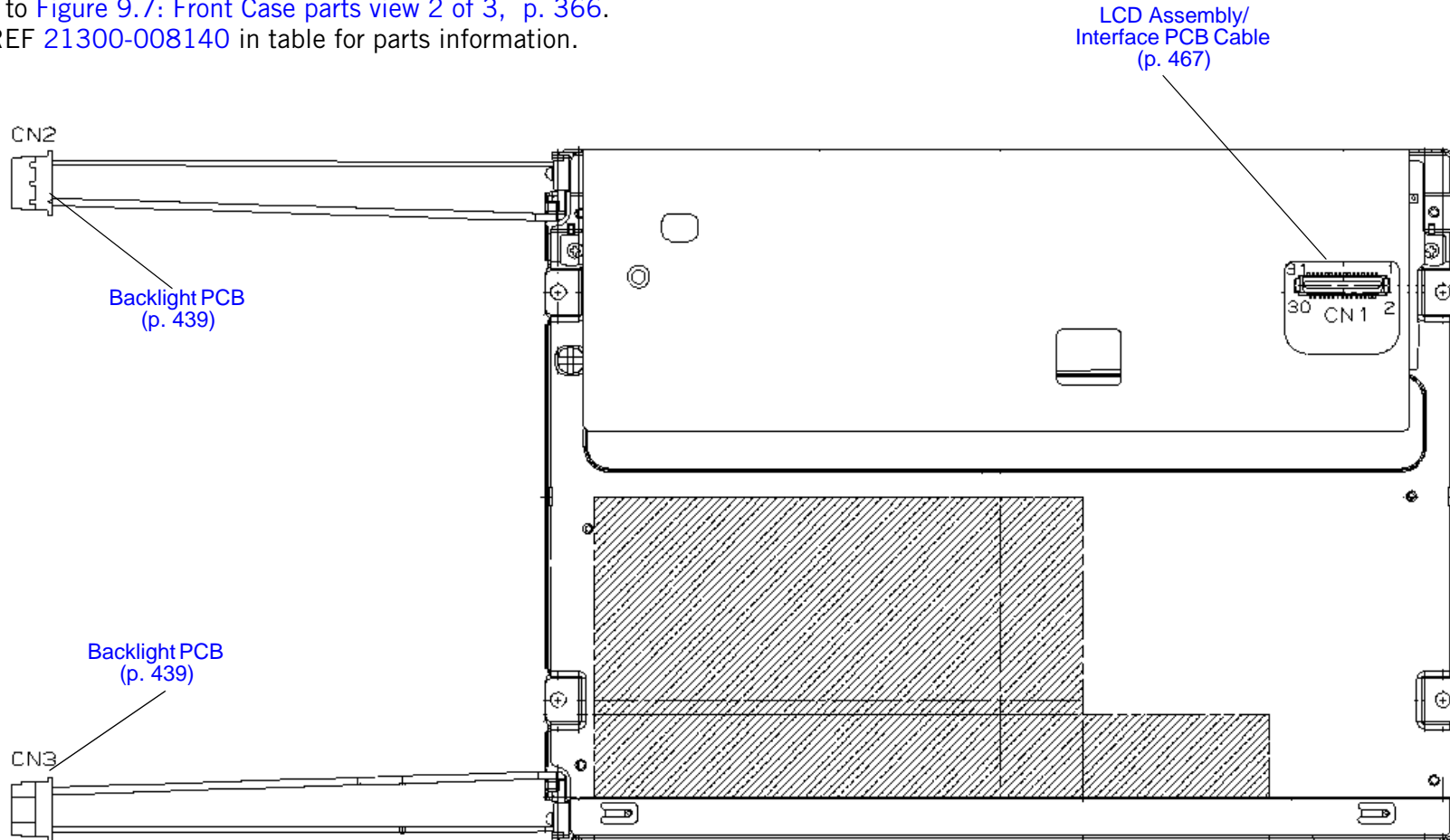
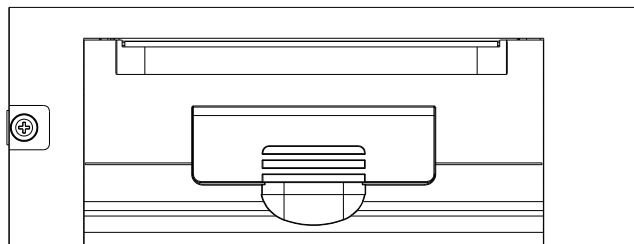

Figure 9.31—Diagram for item A11



### Printer Assembly

See REF [11241-000009](#) in table for parts information.



100-mm printer

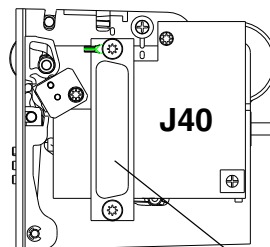

Printer Assembly/  
Interface PCB Cable  
(p. 465)

Figure 9.32—Diagram for item A12

### Energy Storage Capacitor

Refer to [Figure 9.19: Rear Case view 5 of 6, p. 391](#).  
See REF [21300-004232](#) in table for parts information.

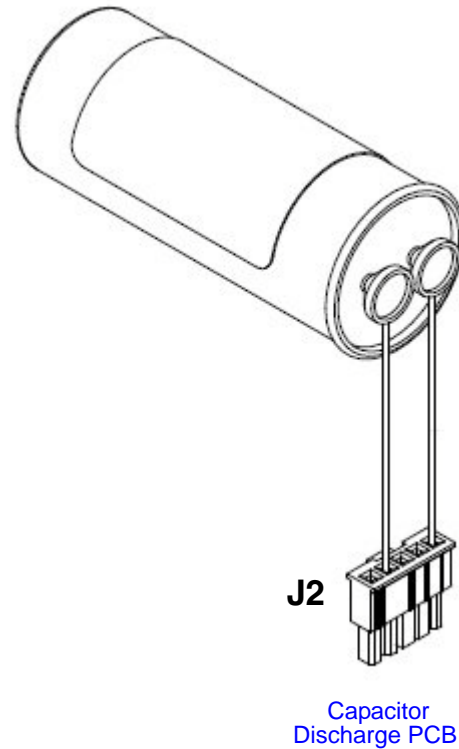

Figure 9.33—Diagram for item A15

### SpO2 Module

Refer to [Figure 9.21: NIPB, CO2, and SpO2 view 1 of 1, p. 398.](#)  
See REF [21330-001530](#) in table for parts information.

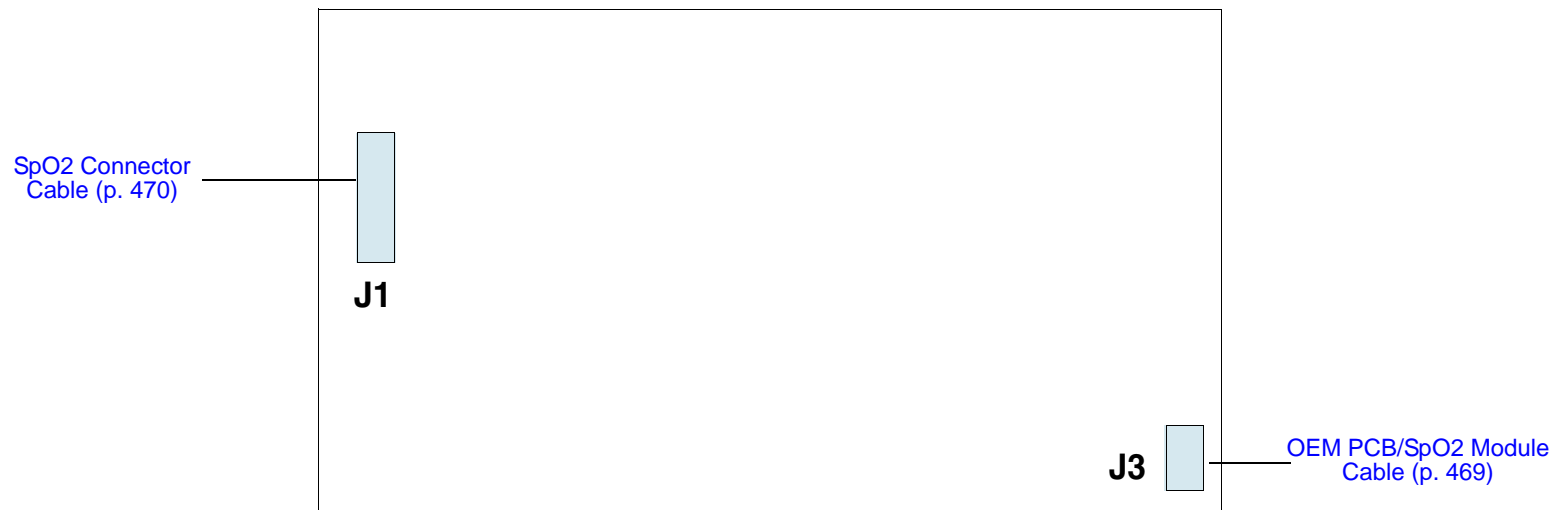

Figure 9.34—Diagram for item A16

### NIBP Module

Refer to [Figure 9.21: NIBP, CO2, and SpO2 view 1 of 1, p. 398.](#)  
See REF [21330-001556](#) in table for parts information.

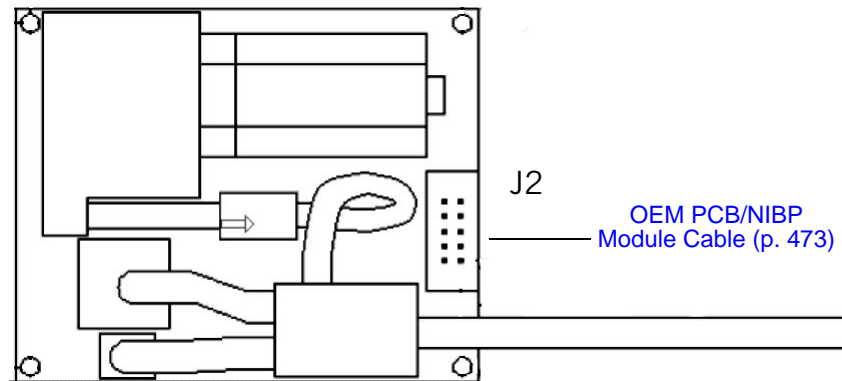

Figure 9.35—Diagram for item A21

### CO2 Module

Refer to [Figure 9.21: NIPB, CO2, and SpO2 view 1 of 1, p. 398.](#)  
See REF [21330-001529](#) in table for parts information.

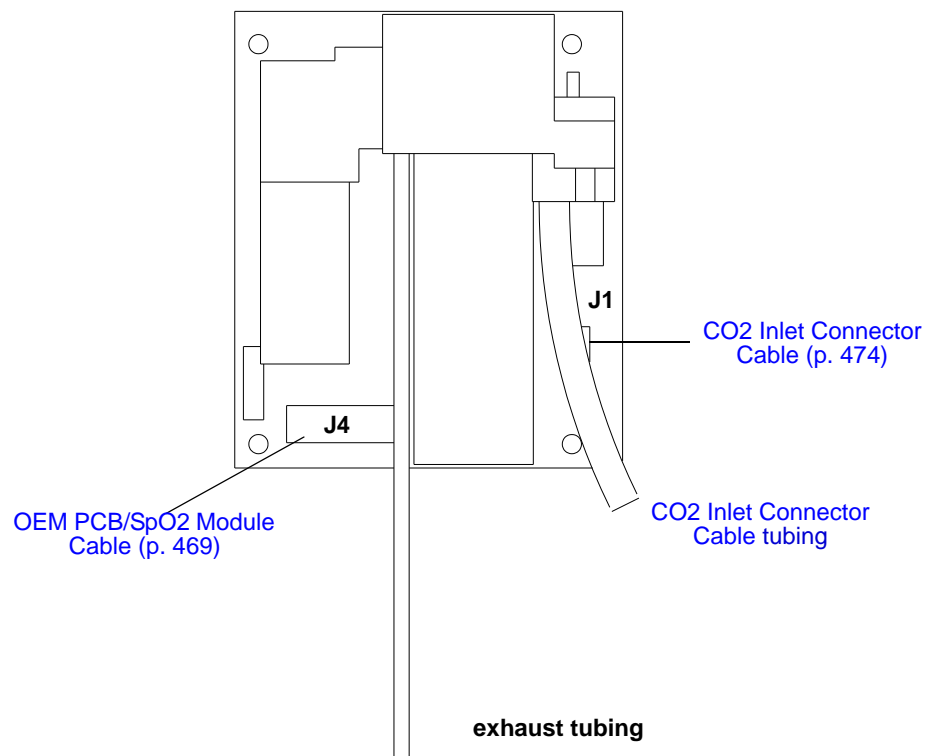

Figure 9.36—Diagram for item A23

### Capacitor Discharge PCB Assembly

Refer to [Figure 9.19: Rear Case view 5 of 6, p. 391](#).  
See REF [21330-001536](#) in table for parts information.

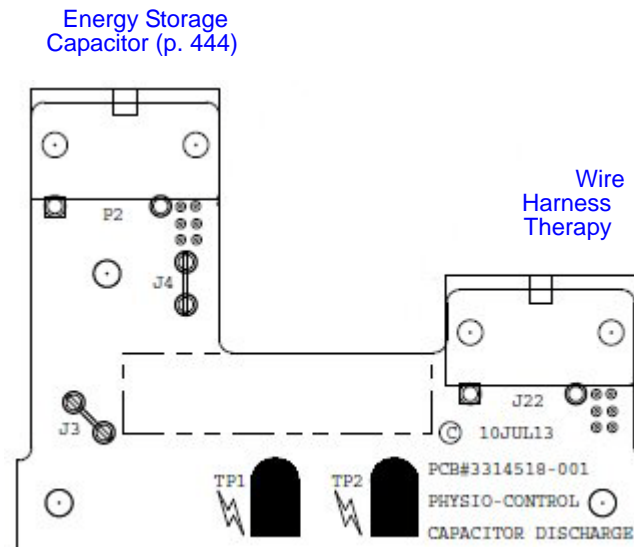

Figure 9.37—Diagram for item A24

### Power PCB/System PCB Cable

Refer to [Figure 9.18: Rear Case view 4 of 6, p. 390](#).  
See REF [21300-007456](#) in table for parts information.

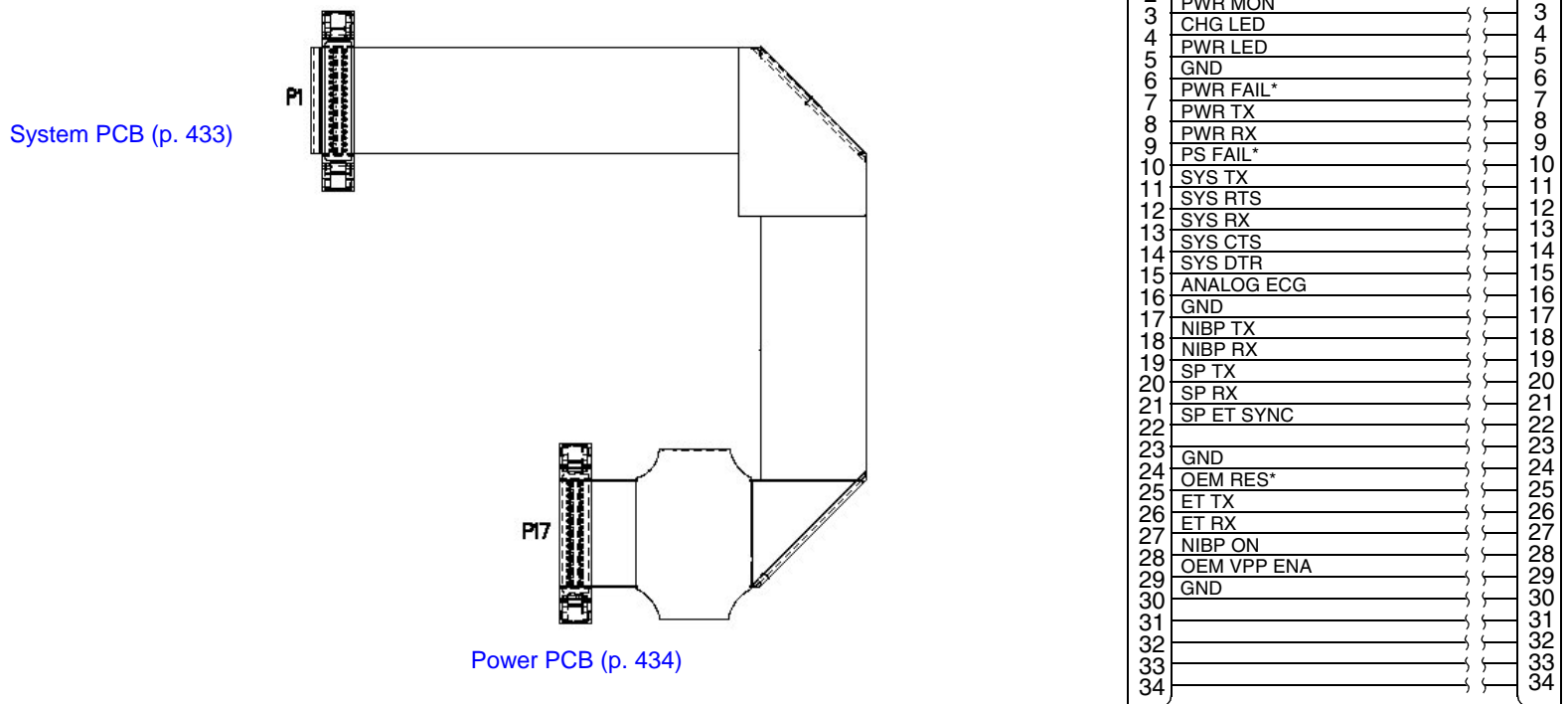

Figure 9.38—Diagram for item W01

### Power PCB/Therapy PCB Cable

Refer to [Figure 9.18: Rear Case view 4 of 6](#), p. 390.  
See REF [21300-007456](#) in table for part information.

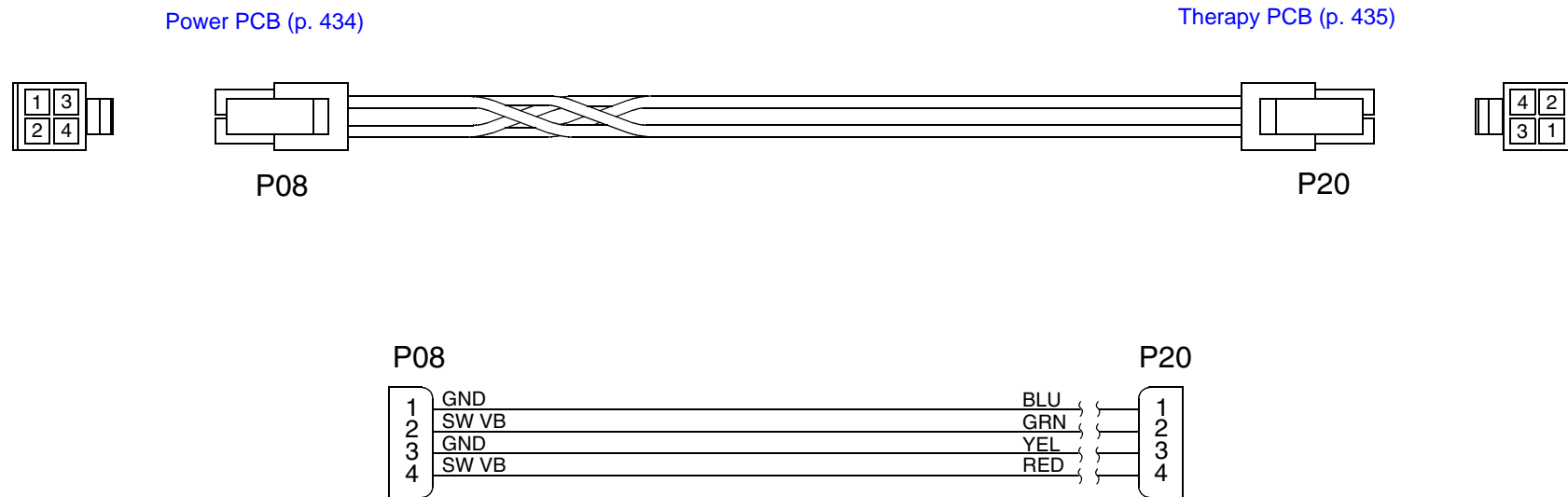

Figure 9.39—Diagram for item W02



### System PCB/Therapy PCB Connector

Refer to [Figure 9.18: Rear Case view 4 of 6, p. 390.](#)  
See REF [21300-001379](#) in table for part information.

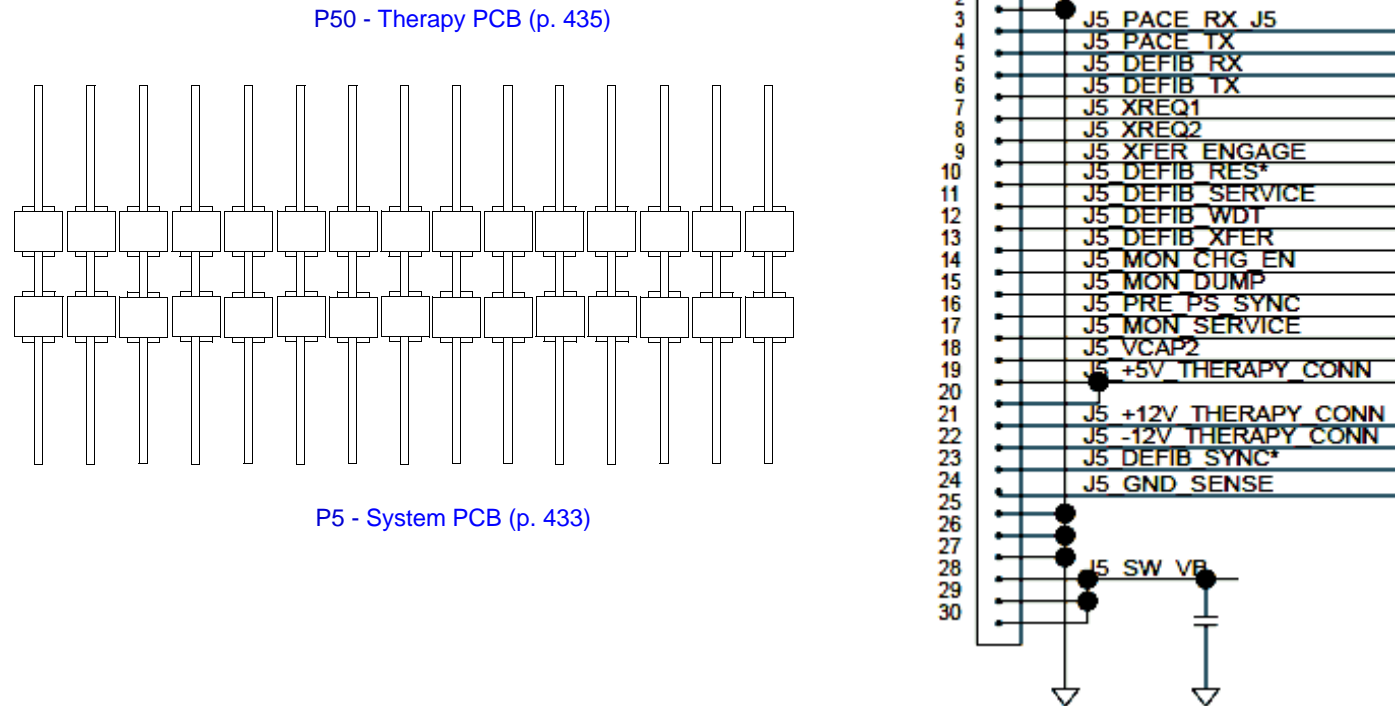

Figure 9.40—Diagram for item W03

### System PCB/Interface PCB Cable

See REF [21330-001226](#) in table for part information.

Interface PCB (p. 436)

System PCB (p. 433)

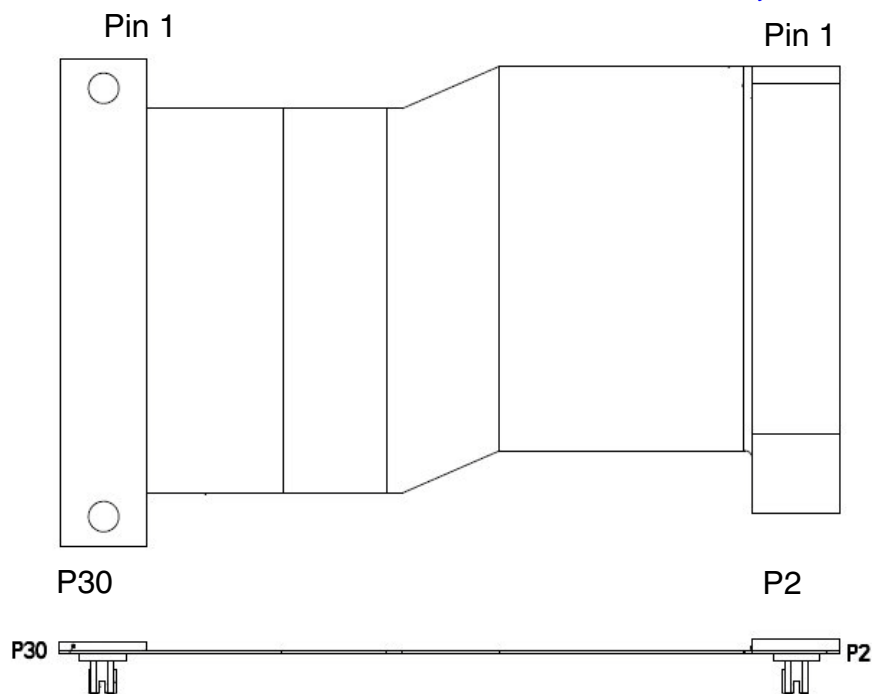

Pinouts P2 to P30			
BT_DTR	1	2	BT_DSR
BT_CTS	3	4	BT_TXD
BT_RTS	5	6	BT_RXD
BT_GREEN	7	8	BT_BLUE
BT_RED_MODE*	9	10	LATCH
CLK	11	12	STB1
STB2	13	14	SW_VB_OUT
DATA	15	16	SW_VB_OUT
THERM2	17	18	PWR_SWITCH
POWER_LED	19	20	+5V_AUDIO
AUDIO	21	22	UC_SERIAL_IN
XREQ_2	23	24	SERVICE
ENC_ON	25	26	ENC0_IN
ENC1_IN	27	28	UC_SHIFT_CTRL
UC_LED_CNTRL	29	30	UC_SHIFT_CLK
UC_SERIAL_OUT	31	32	A_C_LED
CHG_LED	33	34	EMITTER ANODE
SENSOR COLLECTOR	35	36	EMITTER CATHODE
+3.3_BT/LCD	37	38	LCD_BACKLIGHT_EN
BT_RESET*	39	40	+3.3LVDS
GND	41	42	GND
TX PAIR TX0-	43	44	GND
TX0+	45	46	GND
GND	47	48	GND
TX PAIR TX1-	49	50	GND
TX1+	51	52	GND
GND	53	54	GND
TX PAIR TX2-	55	56	GND
TX2+	57	58	GND
GND	59	60	GND
TX PAIR TXCLK-	61	62	GND
TXCLK+	63	64	GND
GND	65	66	GND
TX PAIR TX3-	67	68	GND
TX3+	69	70	GND
GND	71	72	GND
BACKLIGHT_CNTRL	71	72	GND
+5V_LUC	73	74	VHD_PRINT
HEAD TYPE	75	76	VHD_PRINT
MOTOR-	77	78	VHD_PRINT
RL_SEGMENT_DRIVE	79	80	VHD_PRINT
MOTOR+	81	82	VHD_PRINT
RL_BACKPLANE	83	84	+5V_PRINT

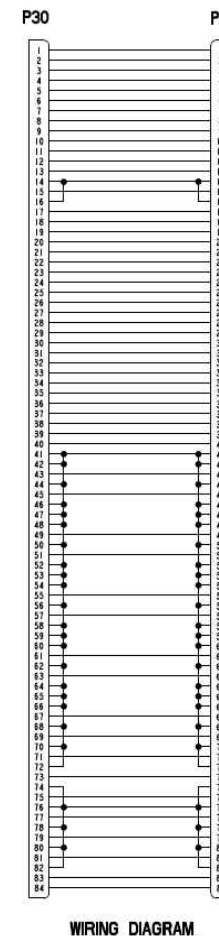

Figure 9.41—Diagram for item W04

### Power PCB/Contact PCB Cable

Refer to [Figure 9.18: Rear Case view 4 of 6, p. 390.](#)  
See REF [21330-001316](#) in table for parts information.

Power PCB (p. 434)

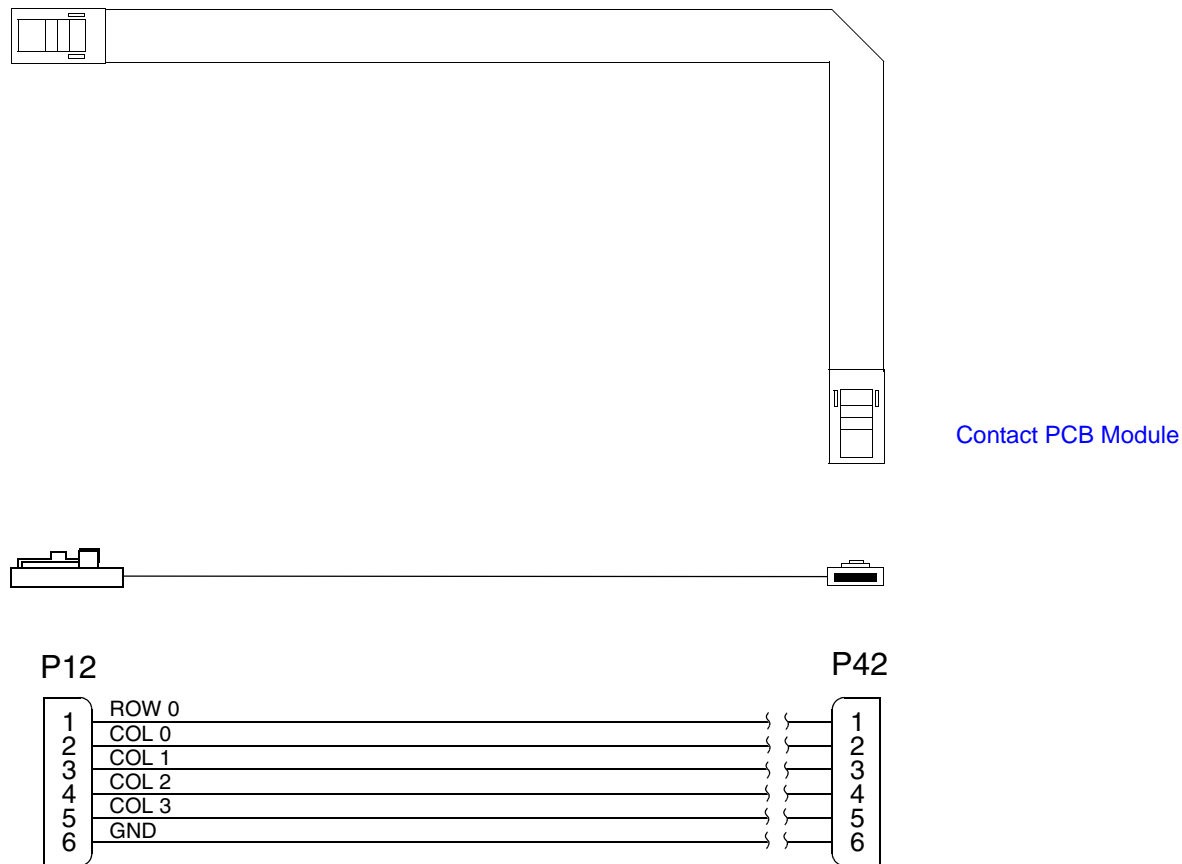

Figure 9.42—Diagram for item W05

### Backlight PCB/Interface PCB Cable

Refer to [Figure 9.7: Front Case parts view 2 of 3](#), p. 366.  
See REF [21330-001525](#) in table for parts information.

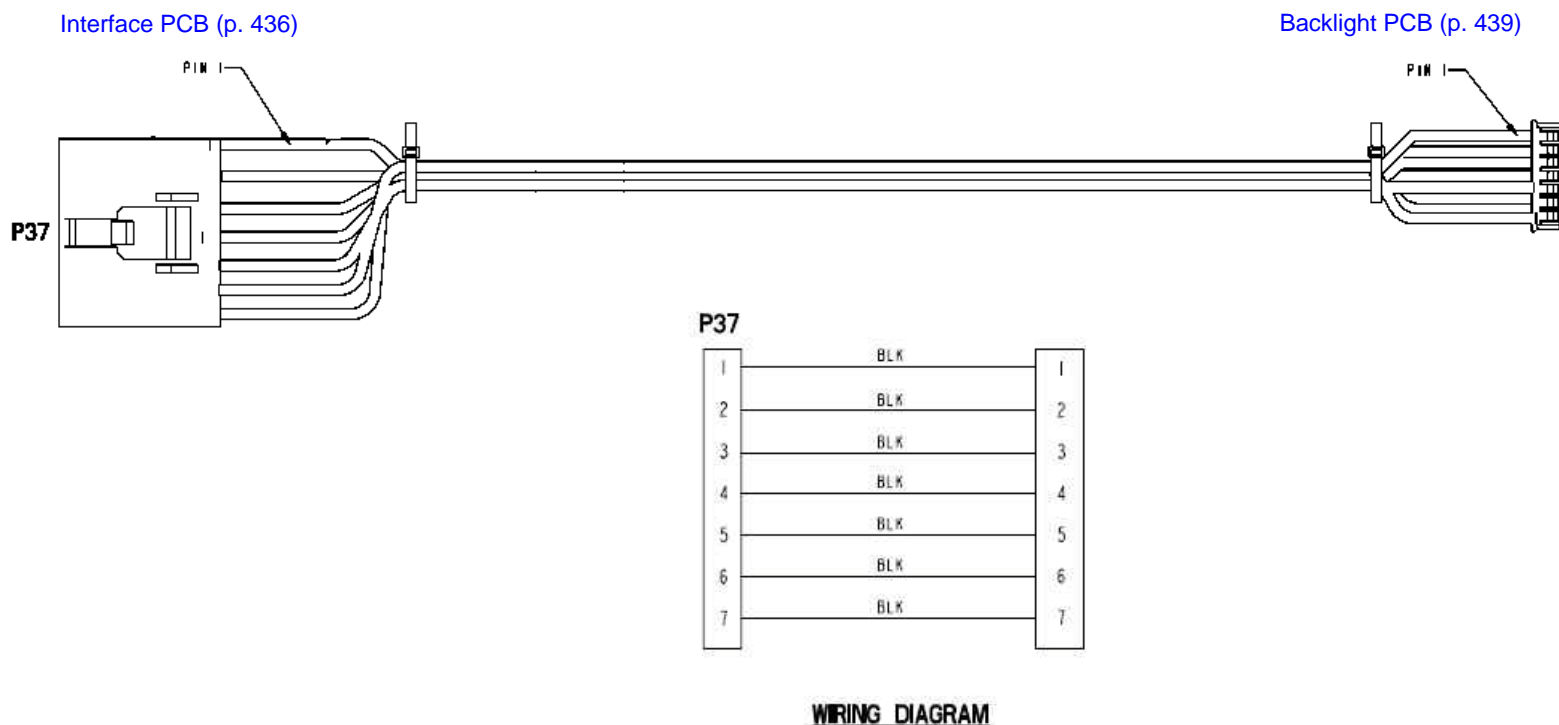

Figure 9.43—Diagram for item W06

### ECG Connector Cable

Refer to [Parameter Bezel Diagrams and Parts List \(p. 379\)](#).  
 Not available as a separate item. Order [ECG Connector Repair Kit \(REF 40577-000037\) \(p. 485\)](#) in table for parts

[System PCB \(p. 433\)](#)

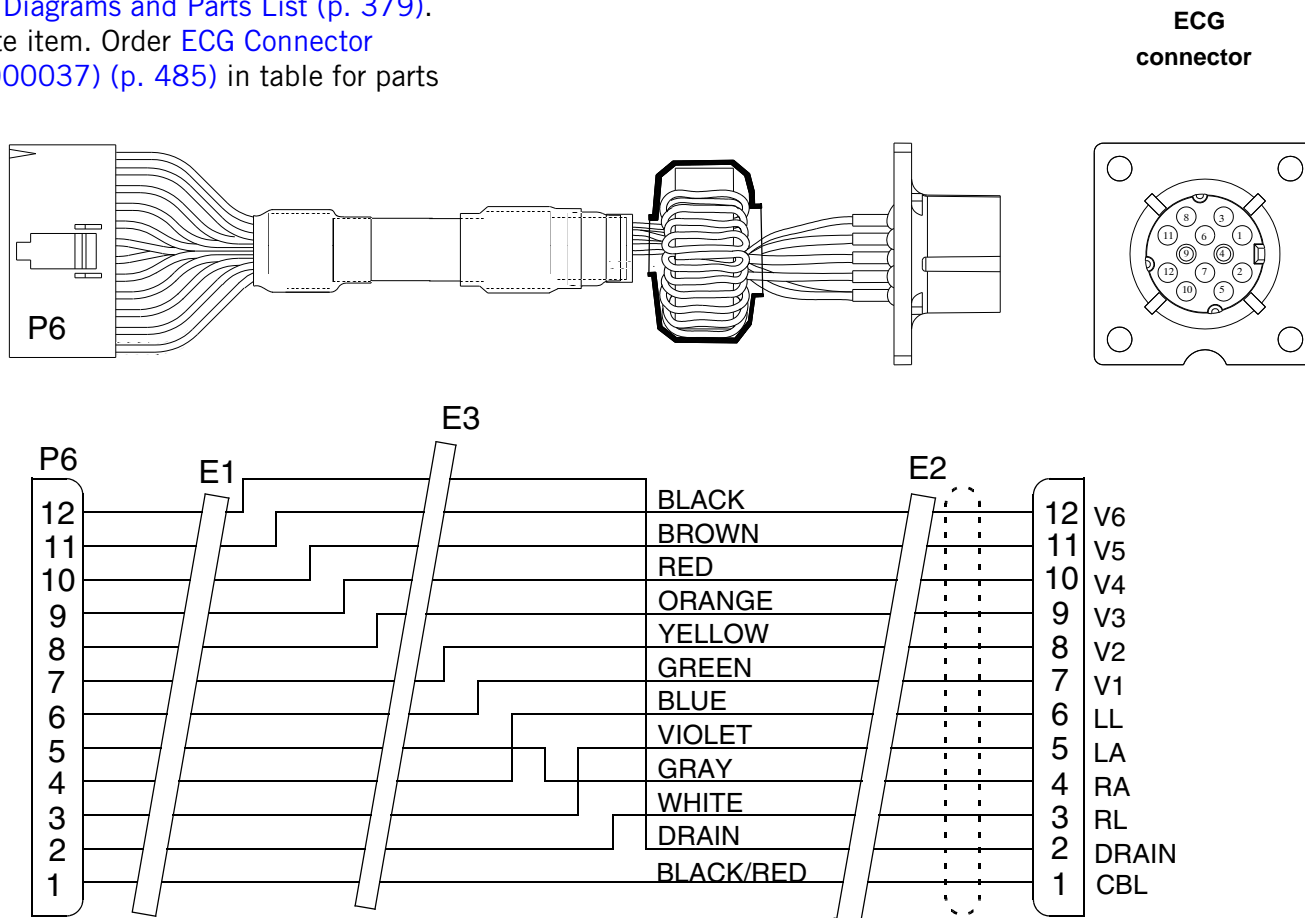

Figure 9.44—Diagram for item W07

### System Connector Cable

Refer to [Figure 9.15: Rear Case view 1 of 6, p. 387.](#)  
See REF [21330-000156](#) in table for part information.

[Power PCB \(p. 434\)](#)

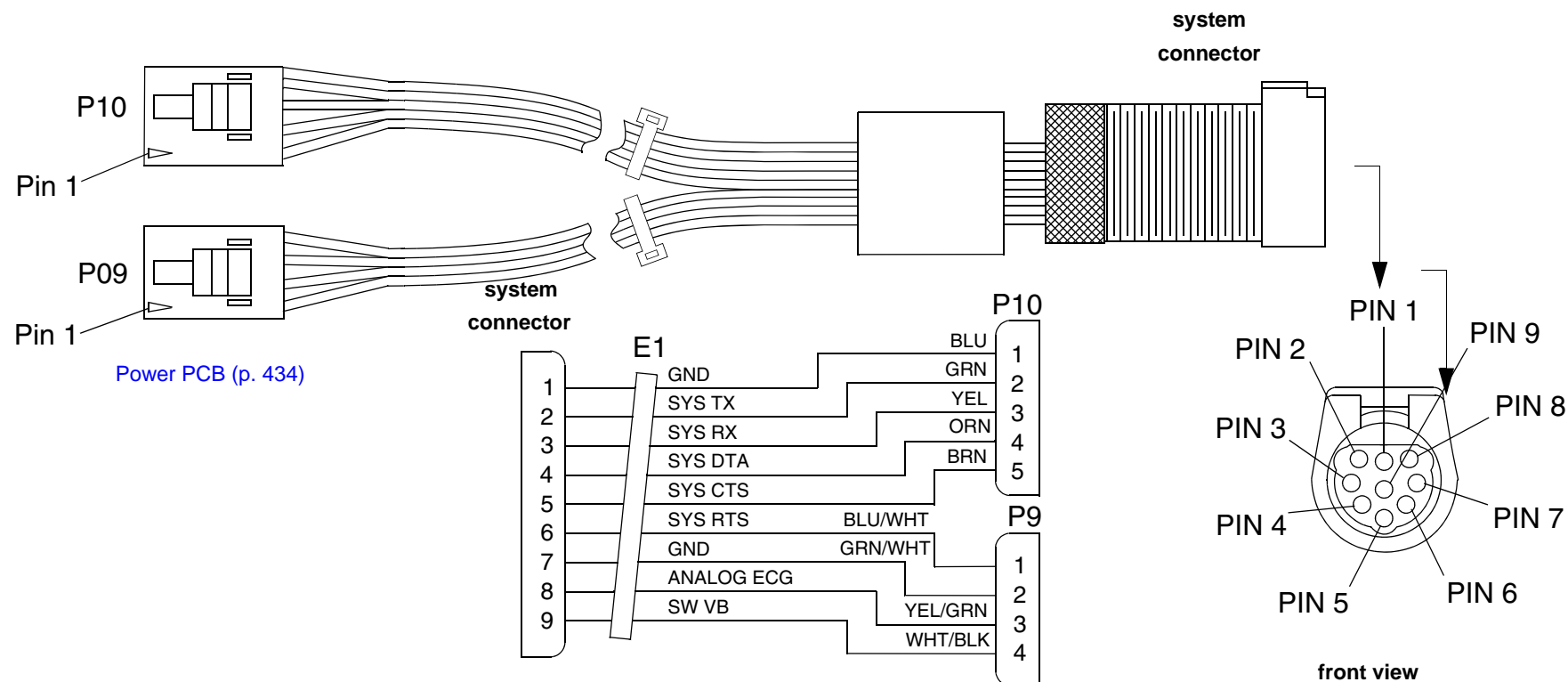

Figure 9.45—Diagram for item W08

### Auxiliary Power Connector Cable

Refer to [Figure 9.15: Rear Case view 1 of 6, p. 387](#).  
See REF [21330-001485](#) in table for part information.

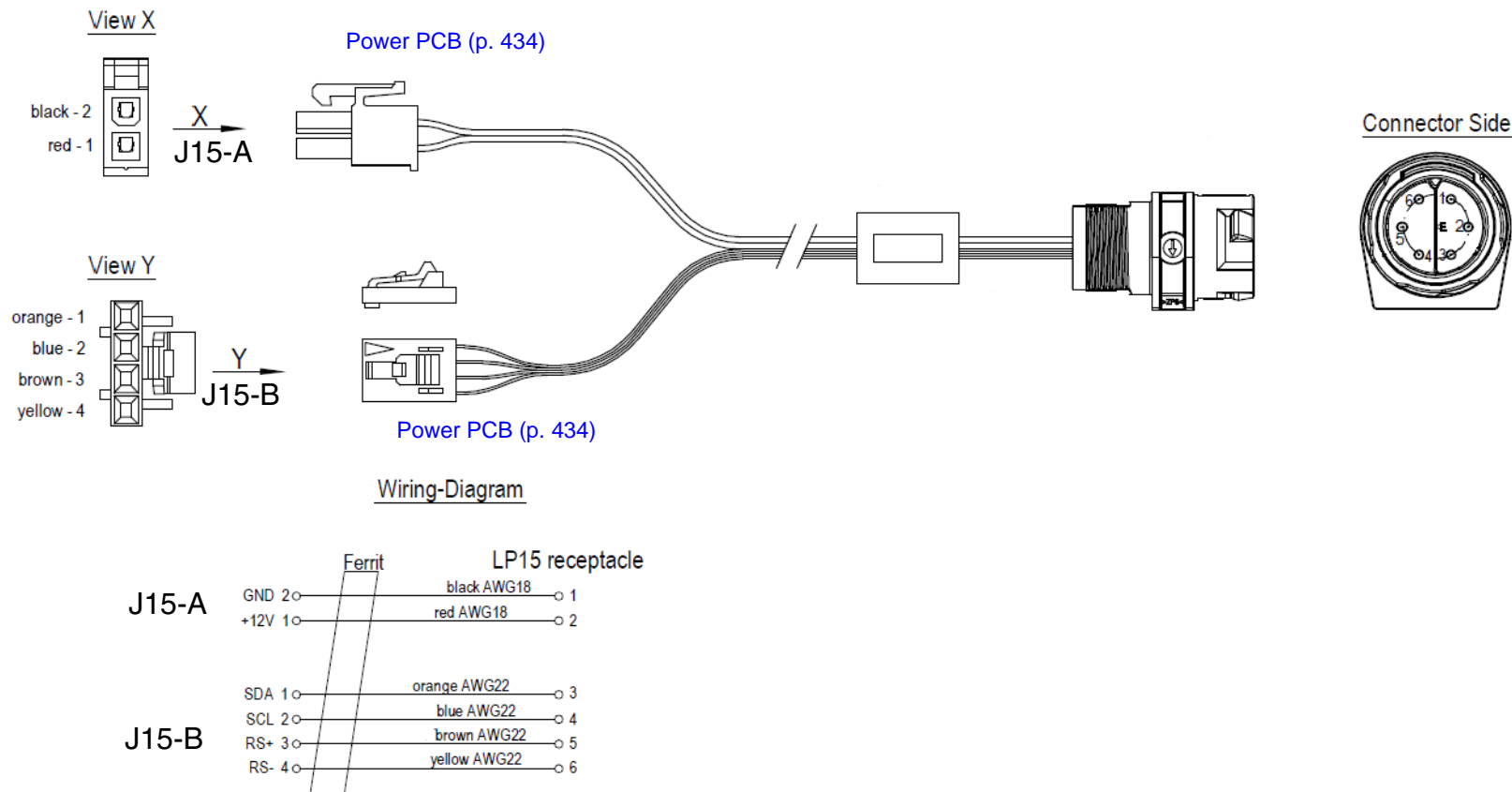

Figure 9.46—Diagram for item W09

### Battery Pins/Power PCB Cable

Refer to [Figure 9.18: Rear Case view 4 of 6, p. 390.](#)  
See REF [21330-001394](#) in table for part information.

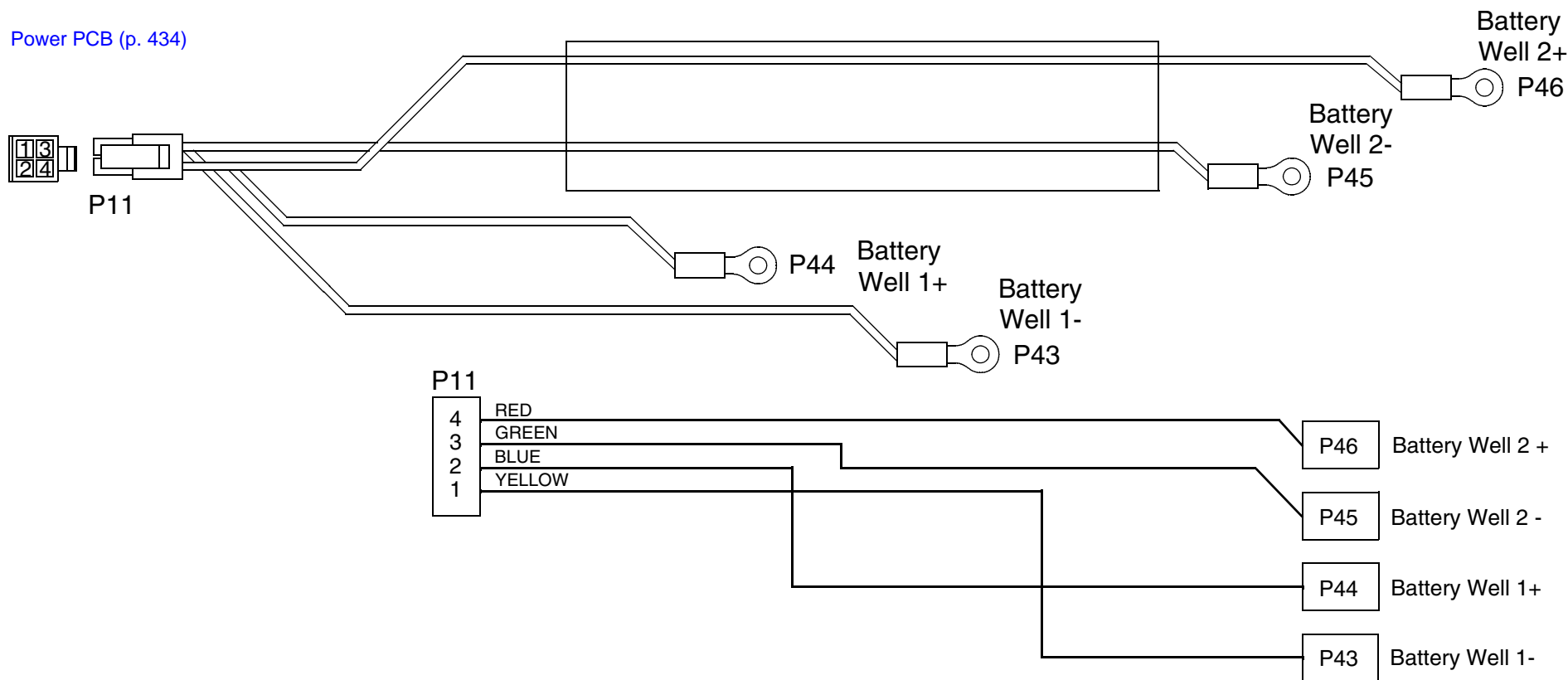

Figure 9.47—Diagram for item W10 (REF [21330-001394](#))



### Battery Pins/Power PCB Cable

Refer to [Figure 9.18: Rear Case view 4 of 6, p. 390](#).  
See REF [21330-001555](#) in table for part information.

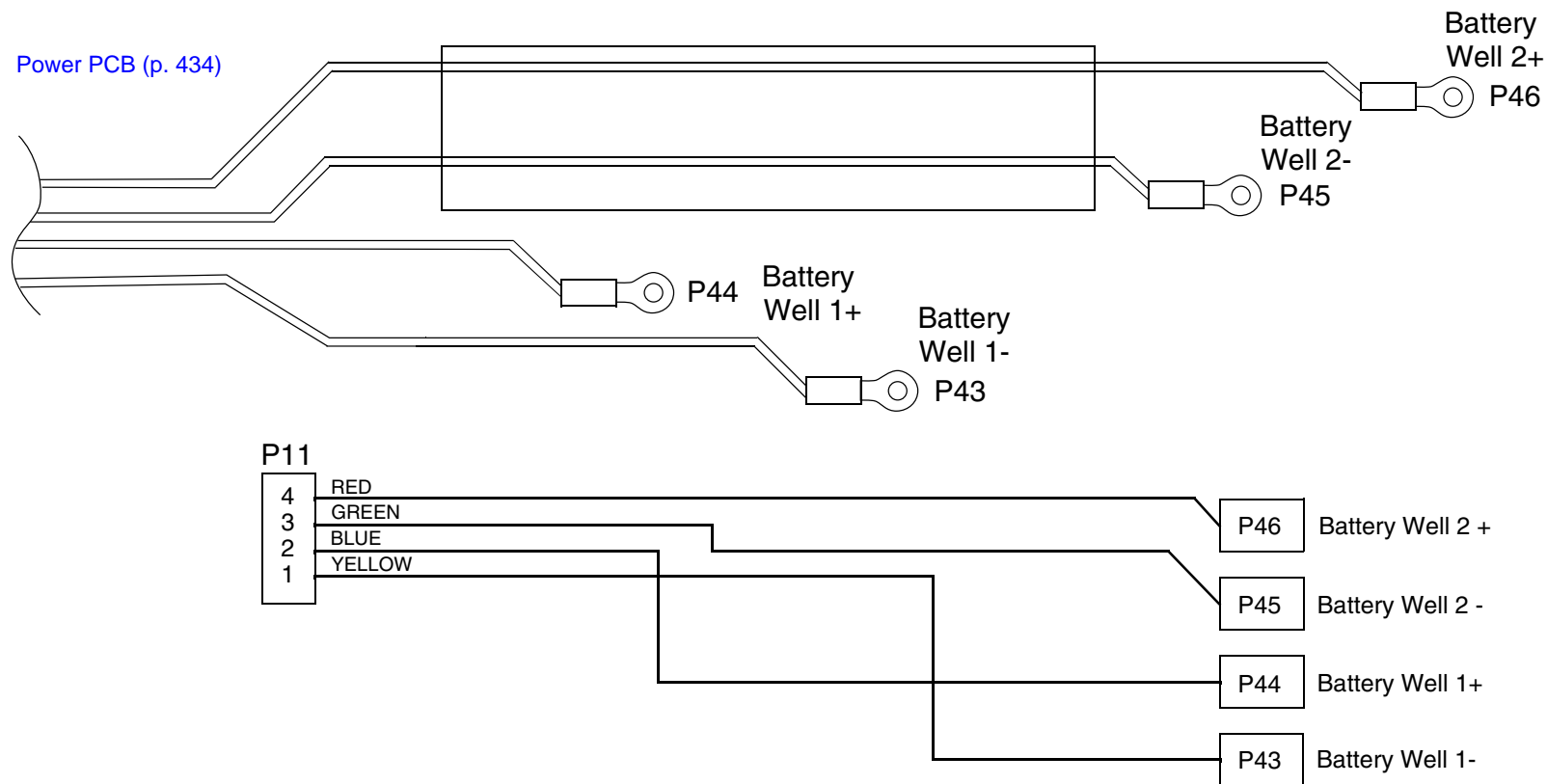

Figure 9.48—Diagram for item W10 (REF [21330-001555](#))

### Therapy Connector Cable

Refer to [Figure 9.6: Front Case parts view 1 of 3, p. 365.](#)  
See REF [21330-001510](#) in table for part

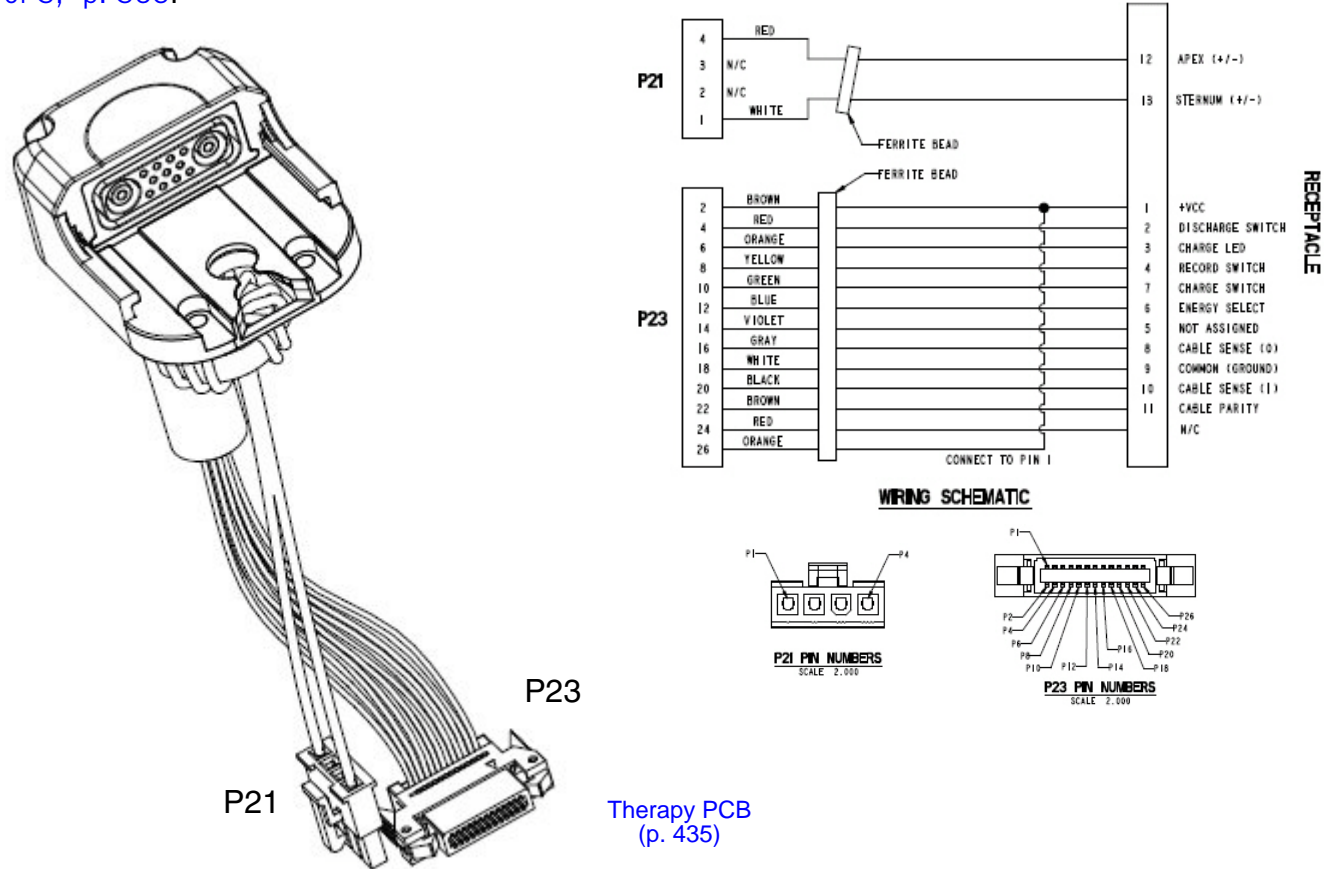

Figure 9.49—Diagram for item W11

### Printer Control Keypad/Interface PCB Cable

Refer to [Figure 9.7: Front Case parts view 2 of 3, p. 366](#).  
See REF [21330-001214](#) in table for parts information.

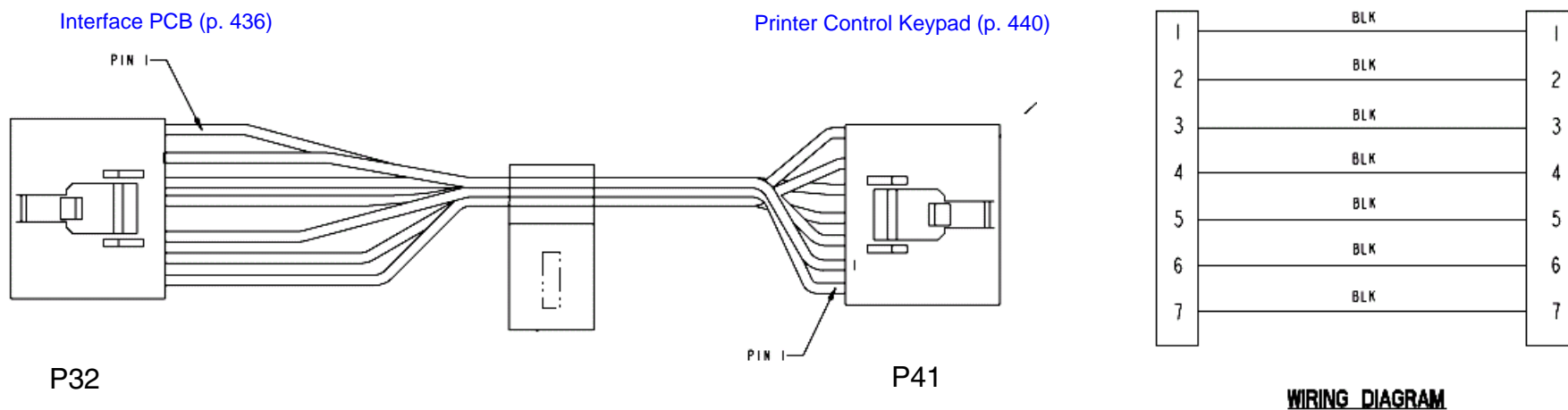

Figure 9.50—Diagram for item W12

### Main Keypad/Interface PCB Cable

Refer to [Figure 9.7: Front Case parts view 2 of 3, p. 366.](#)  
See REF [21330-001323](#) in table for parts information.

[Interface PCB \(p. 436\)](#)

[Main Keypad \(p. 441\)](#)

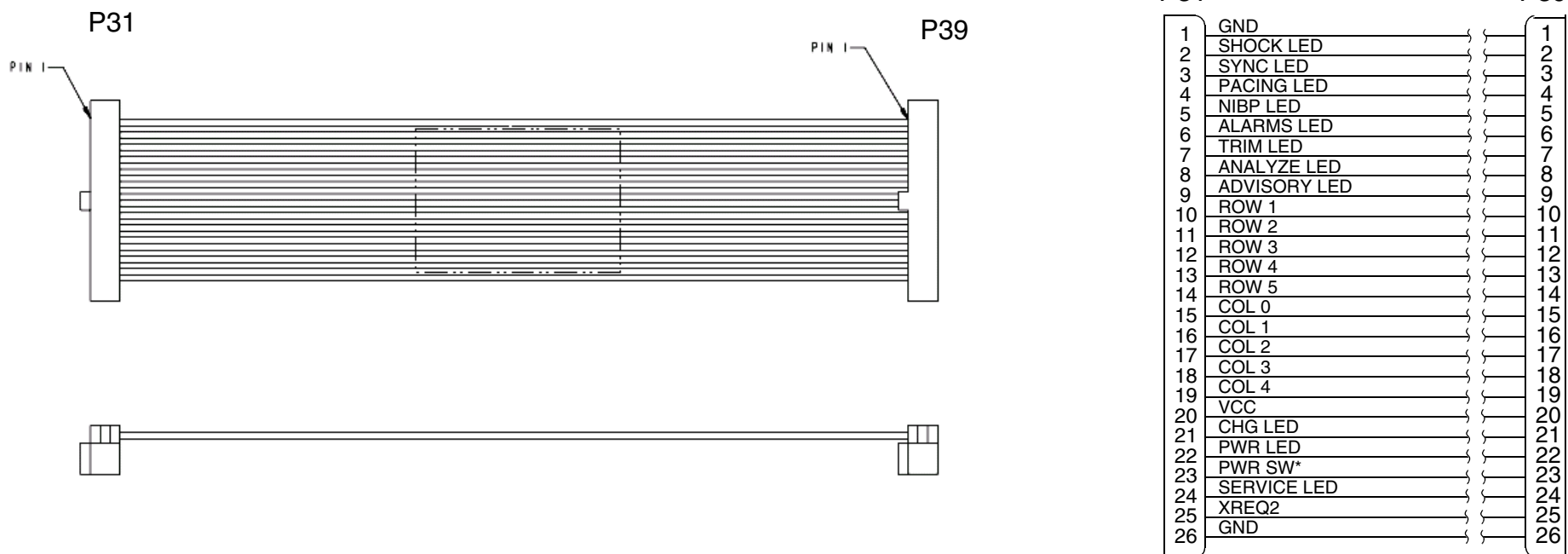
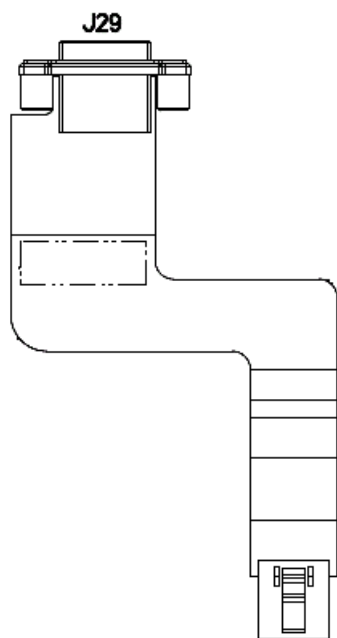

Figure 9.51—Diagram for item W13

### USB Flex Assembly

Refer to [Figure 9.17: Rear Case view 3 of 6, p. 389](#).  
See REF [21330-001534](#) in table for parts information.



System PCB (p. 433)

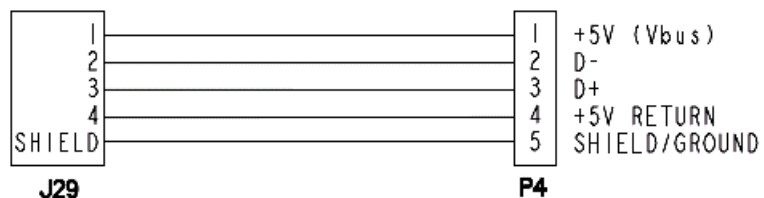

PIN-OUT DIAGRAM

Figure 9.52—Diagram for item W14

### Speed Dial Assembly

Refer to [Figure 9.6: Front Case parts view 1 of 3, p. 365.](#)

See REF [21300-003713](#) in table for parts information.

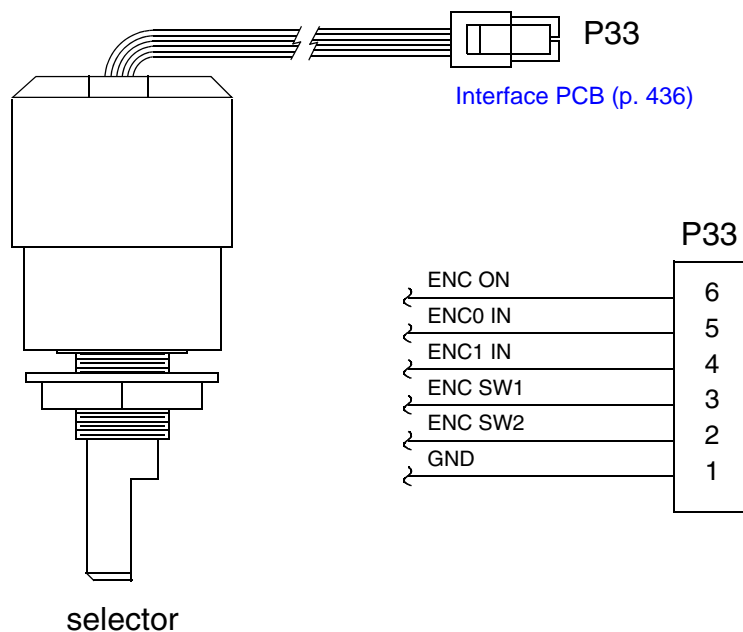
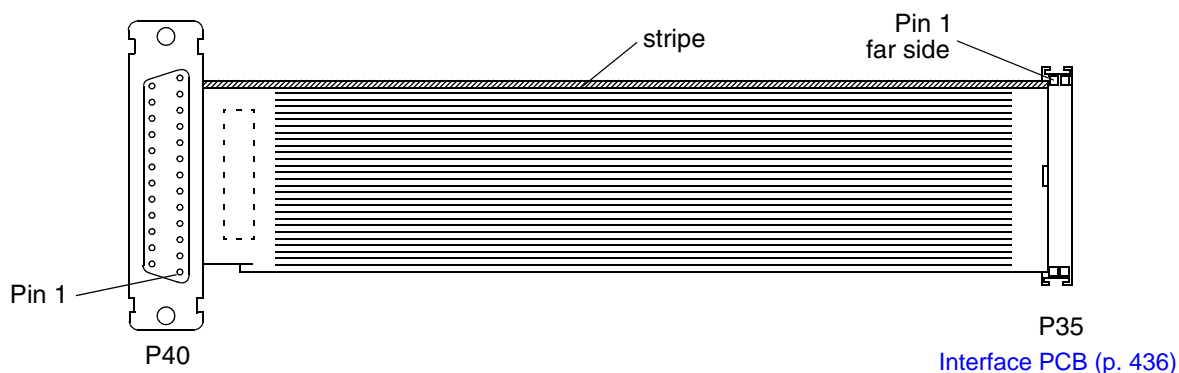

Figure 9.53—Diagram for item W15

### Printer Assembly/Interface PCB Cable

Refer to [Figure 9.8: Front Case parts view 3 of 3, p. 367](#).  
See REF [21330-000165](#) in table for parts information.

Printer Assembly (p. 443)



Printer Pin	Function	PCB Interface Pin
1	ANODE	26
14	COLLECTOR	25
2	EMITTER	24
15	CATHODE	23
3	HEAD TYPE	22
16	VHD	21
4	VHD	20
17	VHD	19
5	VHD	18
18	CLK	17
6	LATCH	16
19	STB2*	15
7	STB1*	14
20	DATA	13
8	VDD	12
21	VSS	11
9	CHASSIS GND	10
22	THERM 1	9
10	GND	8
23	THERM 2	7
11	GND	6
24	GND	5
12	MOTOR +	4
25	GND	3
13	MOTOR -	2
		1

Figure 9.54—Diagram for item W16

### Speaker Assembly

Refer to [Figure 9.7: Front Case parts view 2 of 3, p. 366](#).  
See REF [21300-001371](#) in table for parts information.

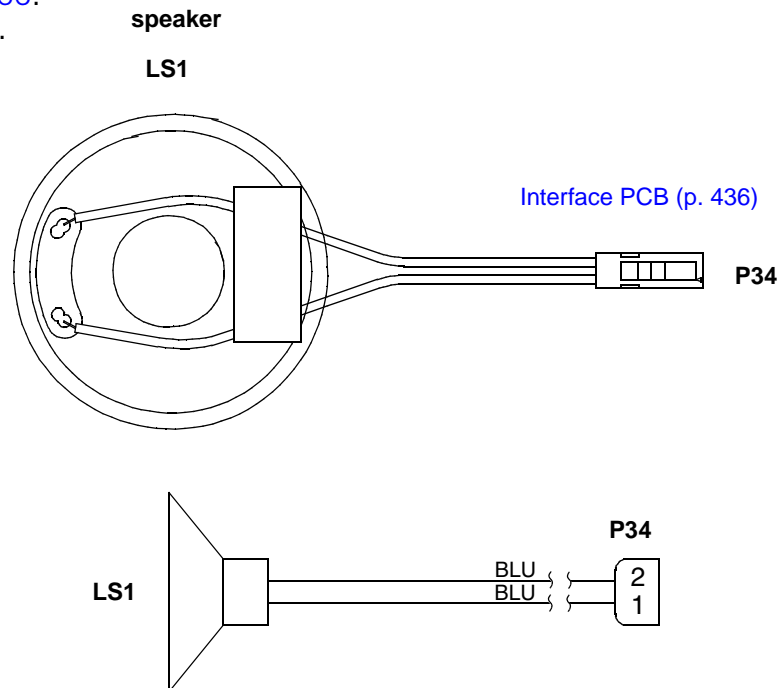

Figure 9.55—Diagram for item W17



### LCD Assembly/Interface PCB Cable

Refer to [Figure 9.7: Front Case parts view 2 of 3, p. 366](#).  
See REF [21330-001417](#) in table for parts information.

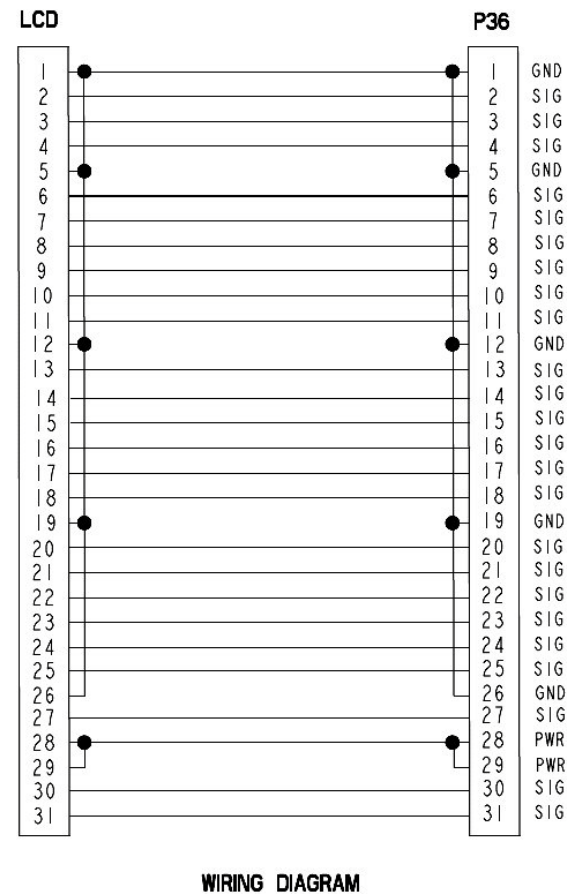
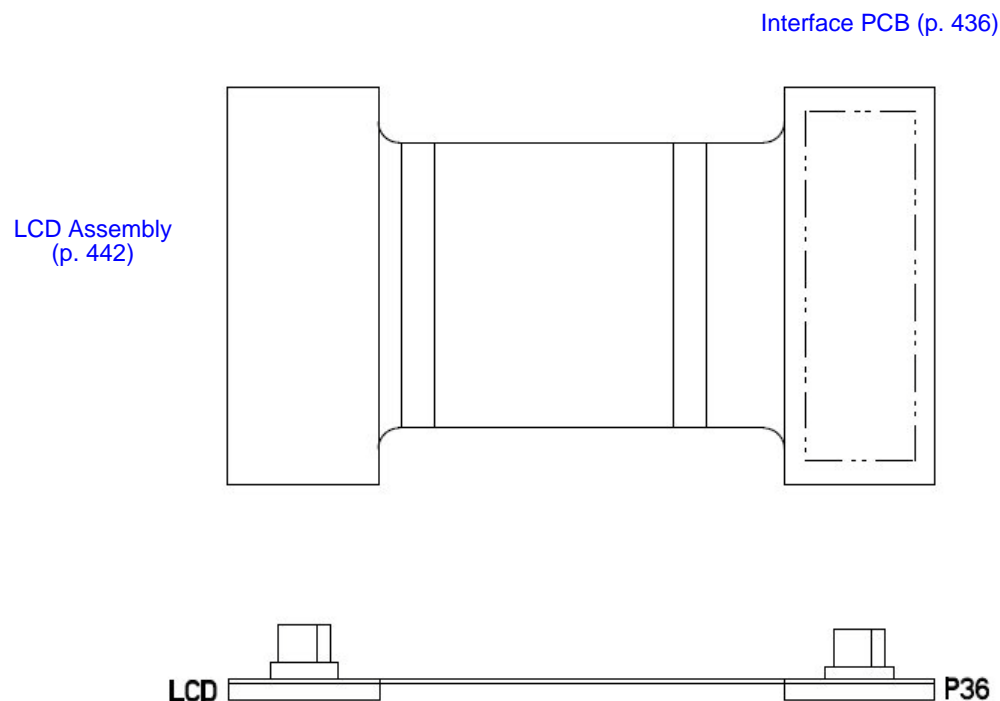

Figure 9.56—Diagram for item W18

### Printer Assembly/Chassis Ground Cable

Refer to [Figure 9.7: Front Case parts view 2 of 3, p. 366](#).  
See REF [21300-001370](#) in table for parts information.



Figure 9.57—Diagram for item W19

### OEM PCB/SpO2 Module Cable

Refer to [Figure 9.21: NIPB, CO2, and SpO2 view 1 of 1, p. 398.](#)  
See REF [21330-001524](#) in table for parts information.

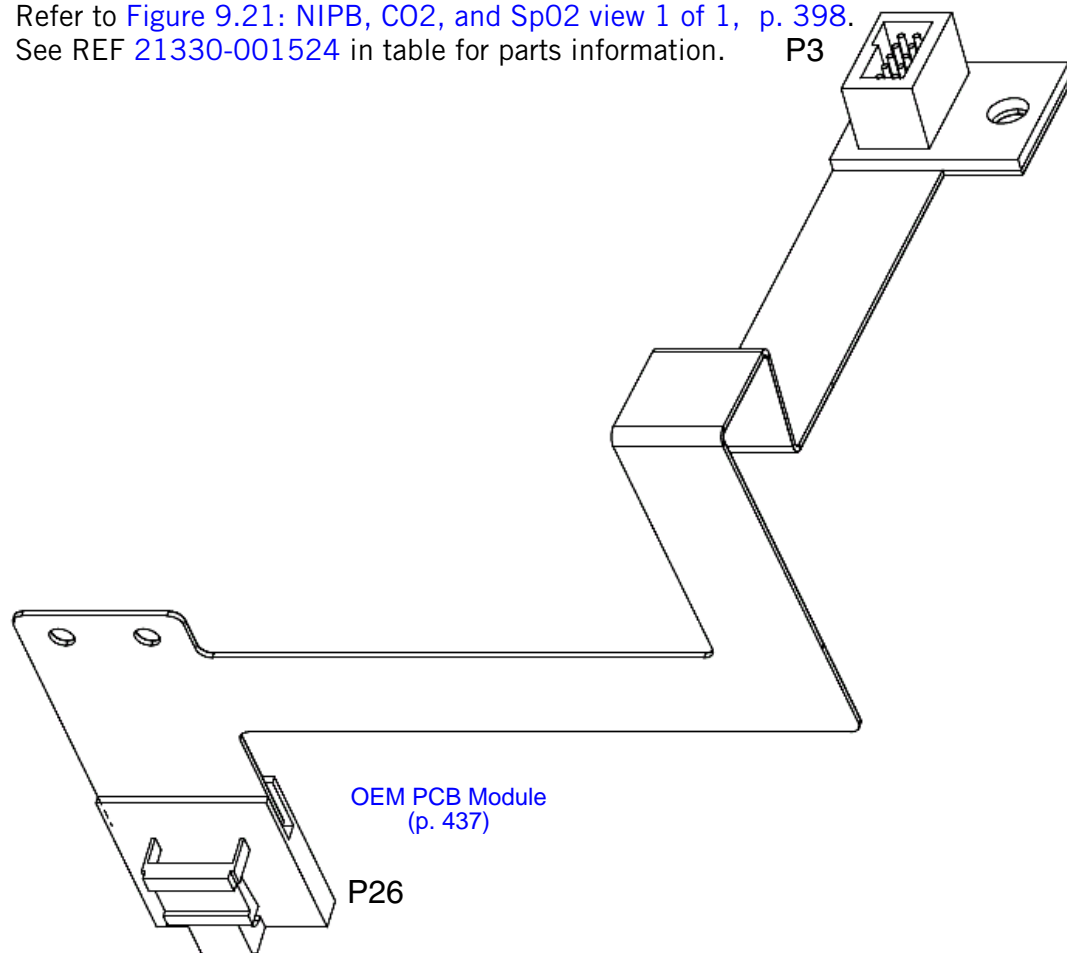

[SpO2 Module \(p. 445\)](#)

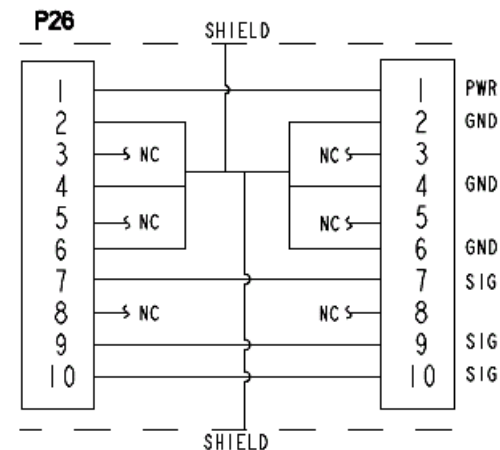

**SCHEMATIC DIAGRAM**

**Figure 9.58—Diagram for item W21**

### SpO2 Connector Cable

Refer to [Parameter Bezel Diagrams and Parts List \(p. 379\)](#) and [NIPB, CO2, and SpO2 view 1 of 1 \(p. 398\)](#)  
See REF [21330-001290](#) in table for parts information.

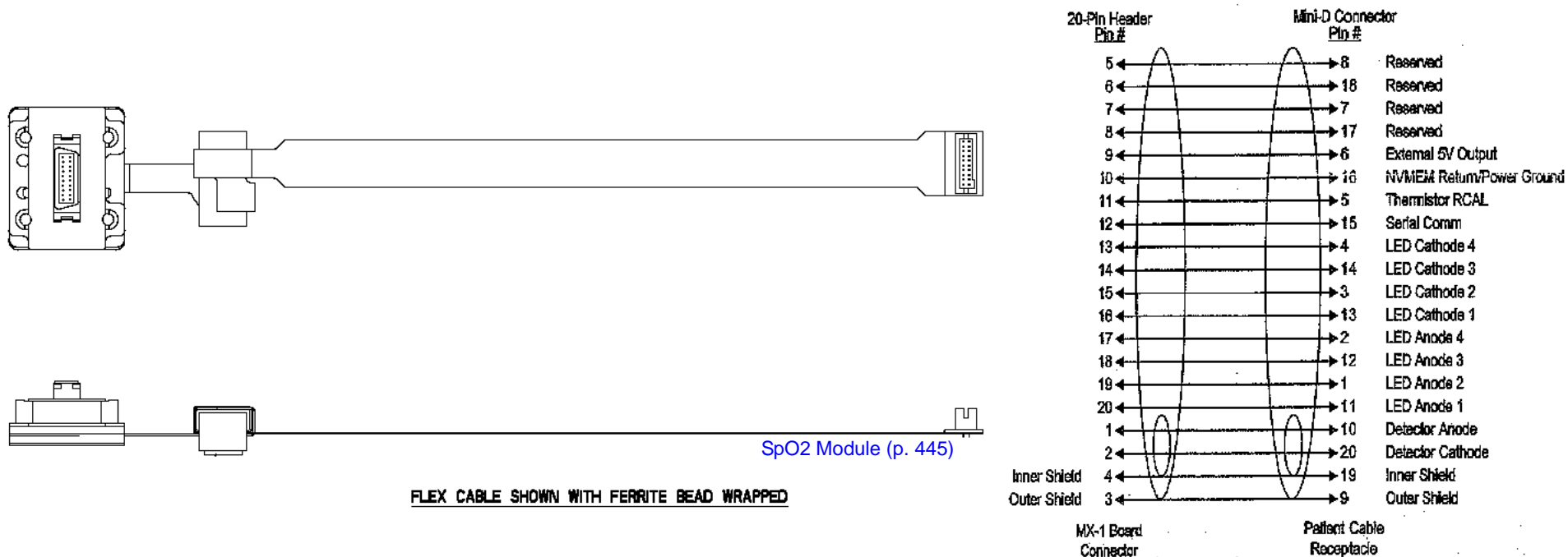

Figure 9.59—Diagram for item W22

### Wire Harness Therapy Capacitor

Refer to [Rear Case view 5 of 6 \(p. 391\)](#).

See REF [21330-001500](#) in table for parts information.

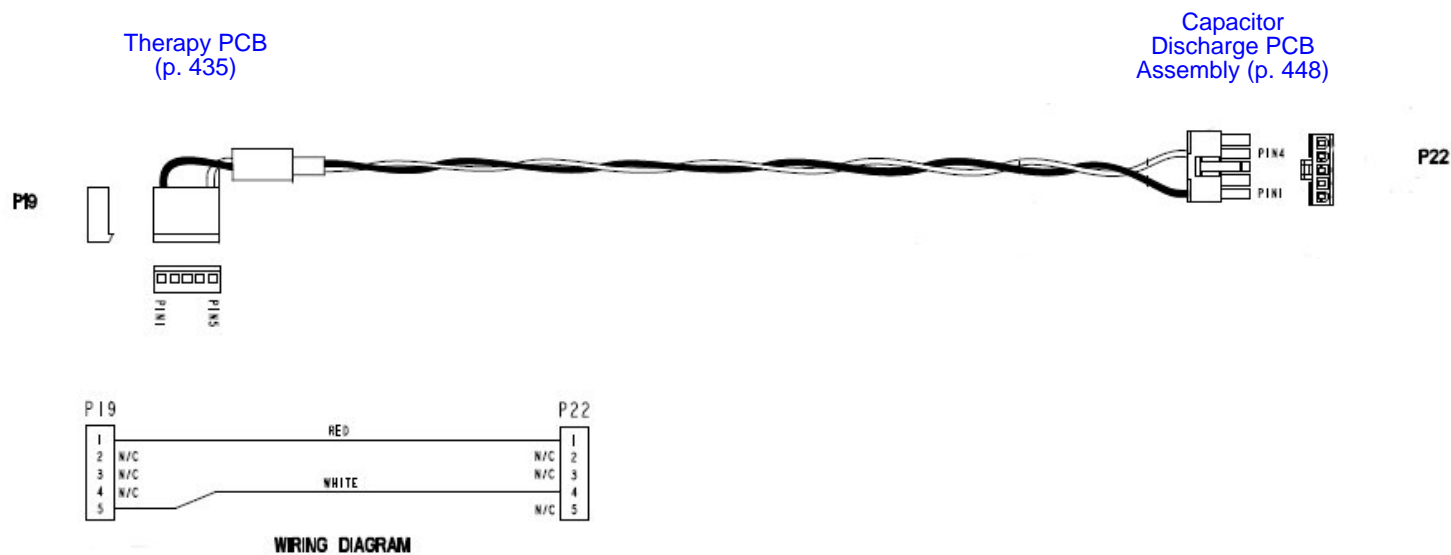
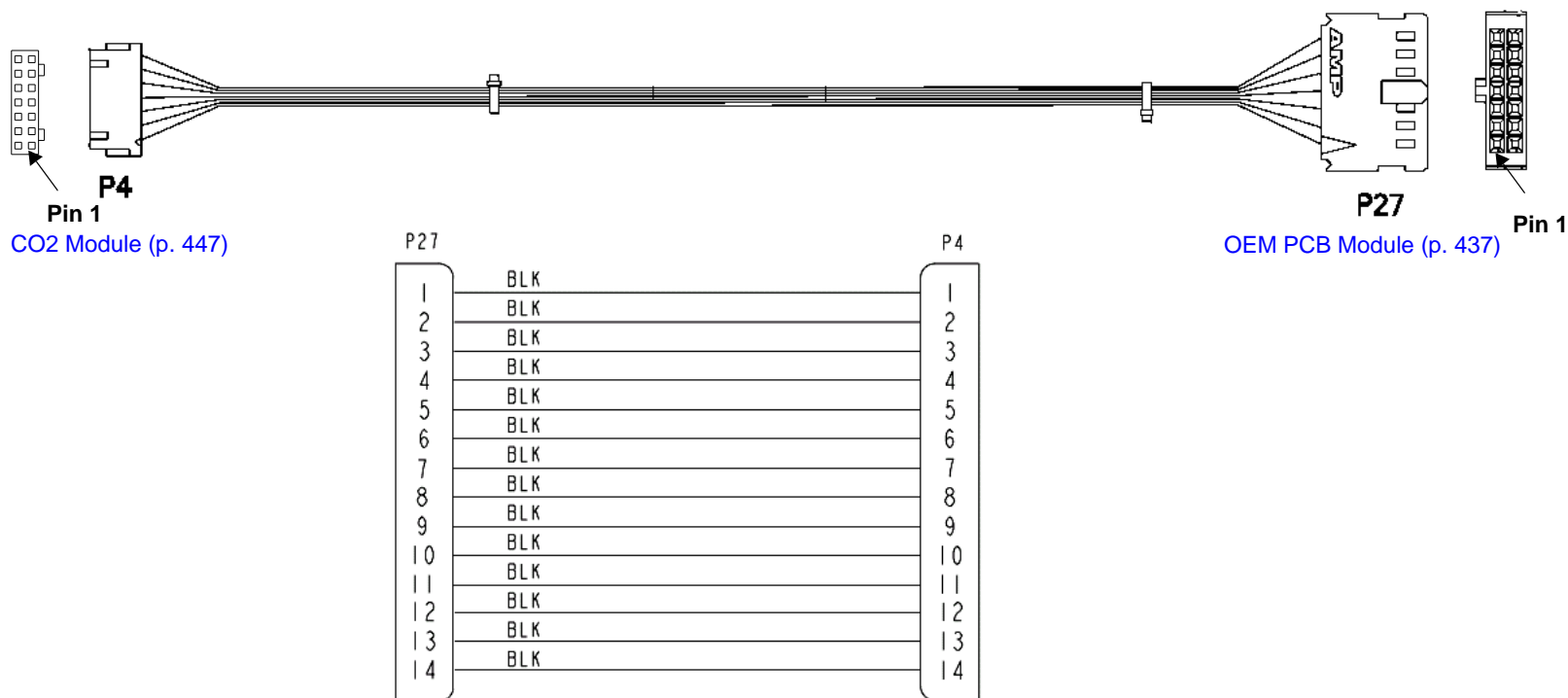

Figure 9.60—Diagram for item W24

### OEM PCB/CO2 Module Cable

Refer to [NIPB, CO2, and SpO2](#) (p. 398).

See REF [21330-001273](#) in table for part information.



### WIRING DIAGRAM

Figure 9.61—Diagram for item W26

### OEM PCB/NIBP Module Cable

Refer to [NIPB](#), [CO2](#), and [SpO2](#) (p. 398).

See REF [21330-000235](#) in table for part information.

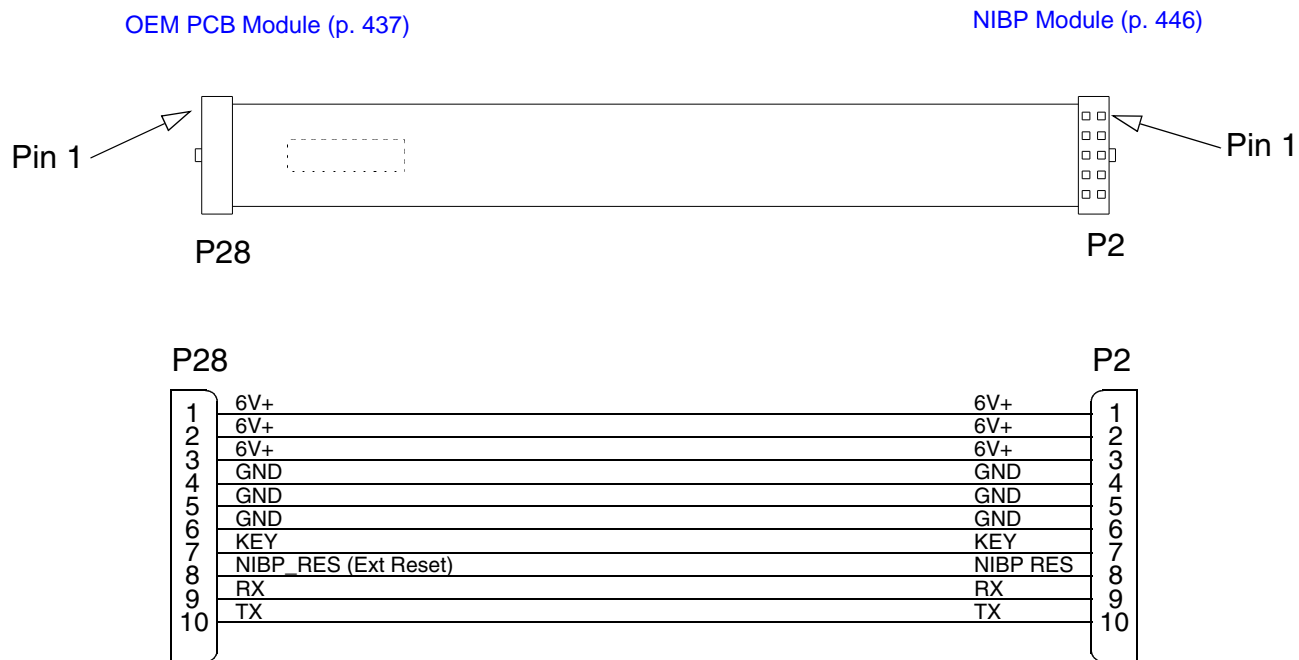

Figure 9.62—Diagram for item W27

### CO2 Inlet Connector Cable

Refer to [Figure 9.12: Parameter Bezel view 2 of 4 \(optional CO2 and NIBP\)](#), p. 380.  
See REF [21330-001529](#) in table for part information.

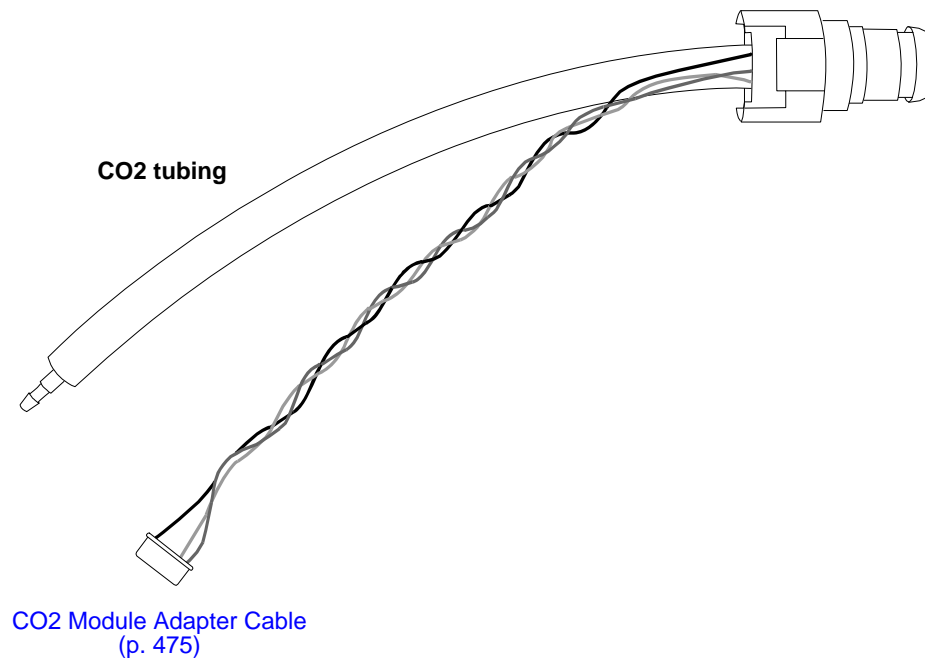

Figure 9.63—Diagram for item W28



### CO2 Module Adapter Cable

See REF [21330-000237](#) in table for part information.

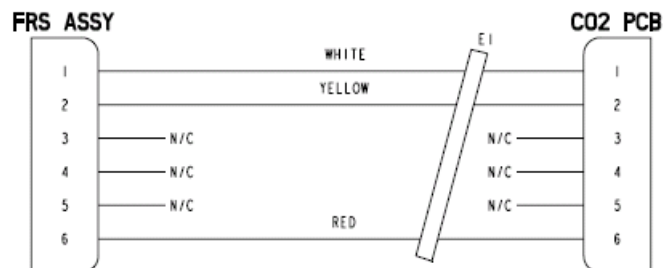
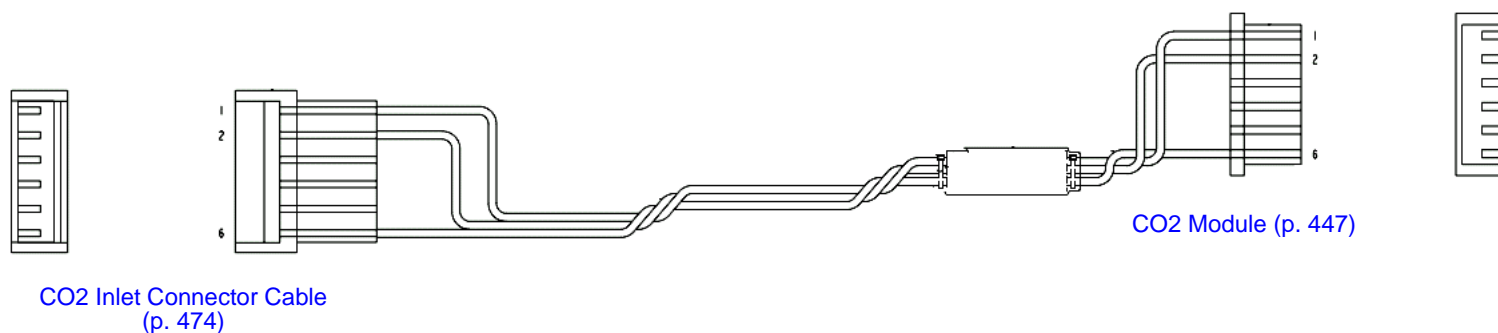

Figure 9.64—Diagram for item W30

### Invasive Pressure Assembly

Refer to [Figure 9.13: Parameter Bezel view 3 of 4 \(optional invasive pressure\)](#), p. 381.  
 See REF [21330-001526](#) in table for parts information.

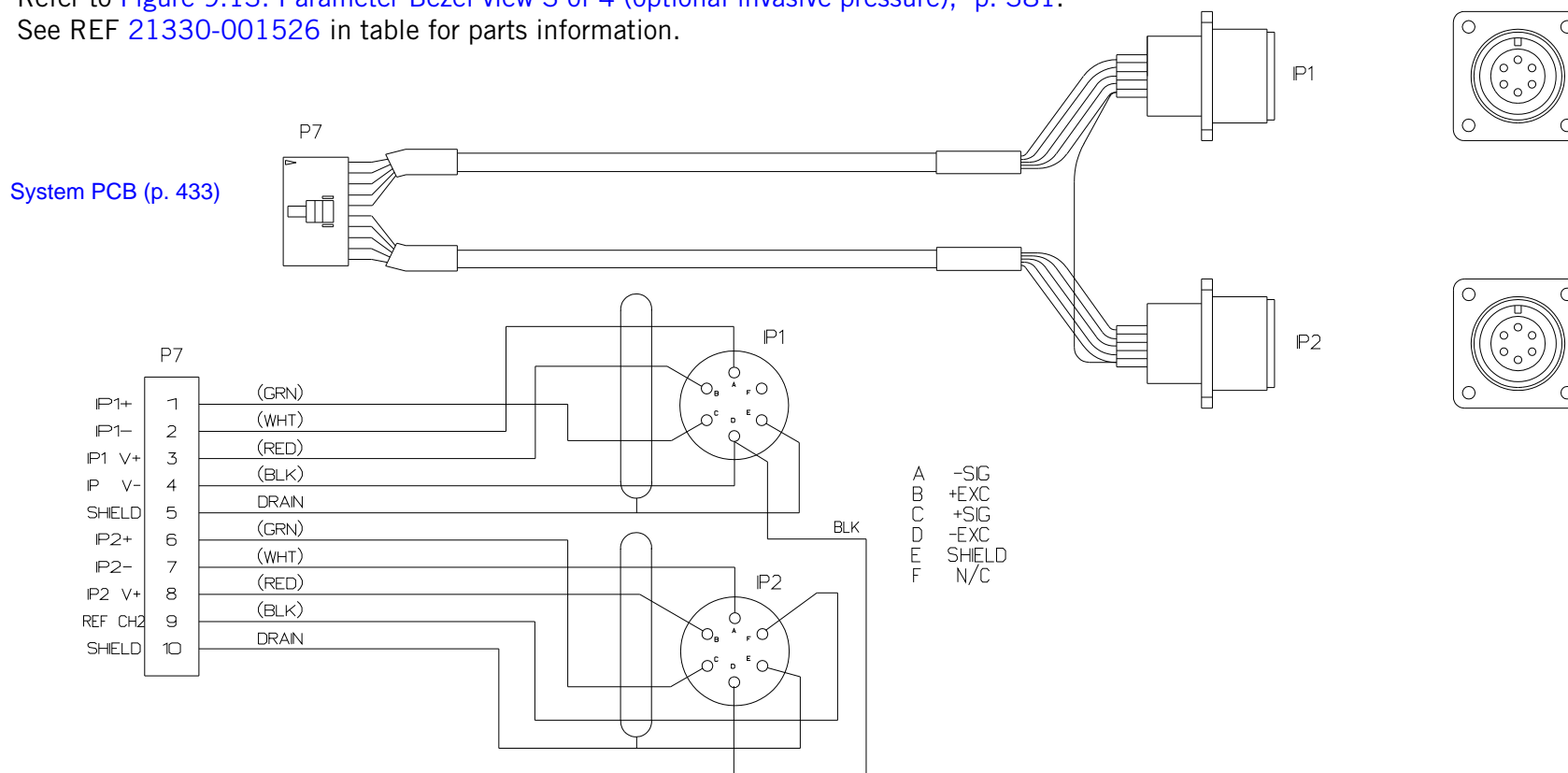

Figure 9.65—Diagram for item W33

### Temperature Connector Cable Assembly

Refer to [Figure 9.14: Parameter Bezel view 4 of 4 \(optional temperature cable assembly\)](#), p. 382.  
See REF [21330-001522](#) in table for parts information.

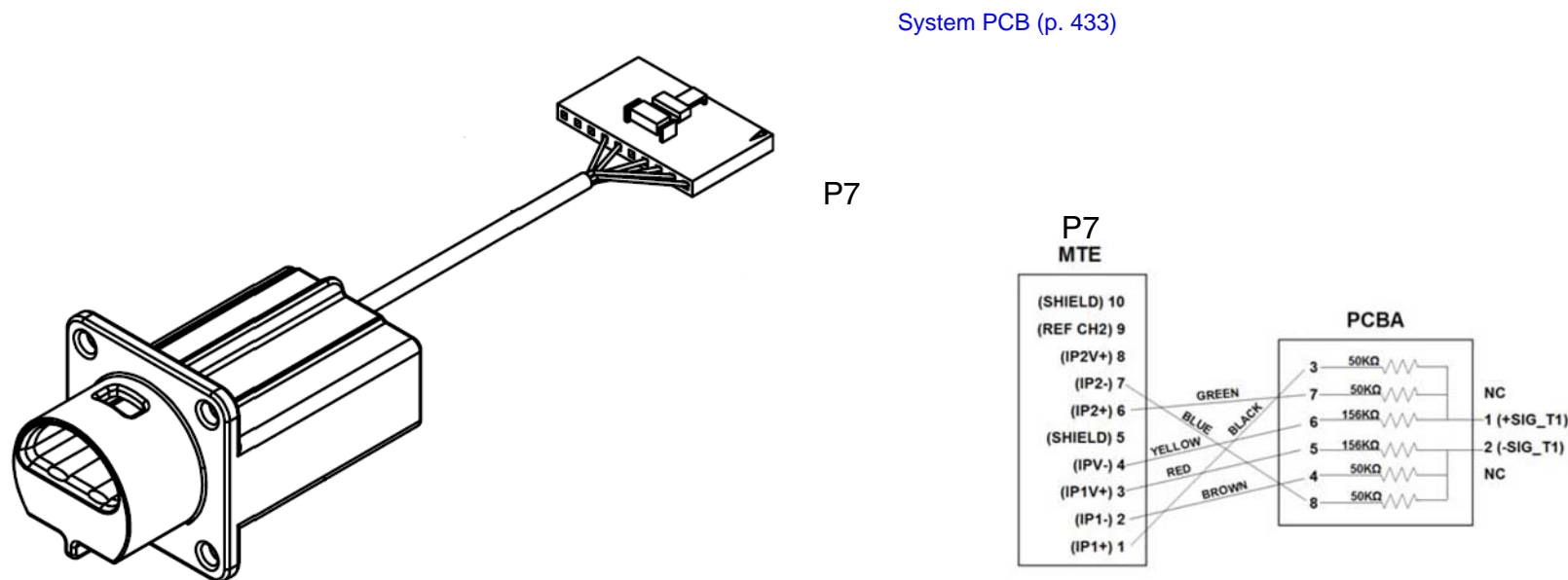

Figure 9.66—Diagram for item W35

### Repair Kits

The repair kits include components that support a particular replacement activity.

Due to the need for special tooling and processes, the front and rear case repair kits come partially assembled from the factory.

**Table 9.16—Repair Kits List**

Repair Kit	CAT Number
<a href="#">NIBP Module Repair Kit (REF 40577-000045) (p. 480)</a>	40577-000045
<a href="#">NIBP MAXIQ 5.2 Repair Kit (REF 40577-000036) (p. 481)</a>	40577-000036
<a href="#">Invasive Pressure Connector Repair Kit (REF 40577-000034) (p. 482)</a>	40577-000034
<a href="#">CO2 Module Repair Kit (REF 40577-000035) (p. 483)</a>	40577-000035
<a href="#">Therapy PCBA Repair Kit (REF 40577-000032) (p. 484)</a>	40577-000032
<a href="#">Therapy Connector Repair Kit (REF 40577-000033) (p. 485)</a>	40577-000033
<a href="#">ECG Connector Repair Kit (REF 40577-000037) (p. 485)</a>	40577-000037
<a href="#">Display Driver Repair Kit (REF 40577-000001) (p. 486)</a>	40577-000001
<a href="#">Display Repair Kit (REF 40577-000044) (p. 486)</a>	40577-000044
<a href="#">CO2 Connector Repair Kit (REF 40577-000038) (p. 487)</a>	40577-000038
<a href="#">Internal Hardware Repair Kit (REF 40577-000003) (p. 488)</a>	40577-000003
<a href="#">External Hardware Repair Kit (REF 40577-000004) (p. 488)</a>	40577-000004
<a href="#">Paddle Retainer Repair Kit (REF 40577-000005) (p. 489)</a>	40577-000005

**Table 9.16—Repair Kits List (Continued)**

Repair Kit	CAT Number
<a href="#">Display Shield Repair Kit (REF 40577-000006) (p. 489)</a>	40577-000006
<a href="#">Guard &amp; Feet Repair Kit (REF 40577-000007) (p. 490)</a>	40577-000007
<a href="#">Handle Repair Kit (REF 40577-000008) (p. 490)</a>	40577-000008
<a href="#">NIBP Connector Repair Kit (REF 40577-000009) (p. 491)</a>	40577-000009
<a href="#">Front Case Repair Kit (REF 40577-000010) (p. 492)</a>	40577-000010
<a href="#">Rear Case Repair Kit (REF 40577-000011) (p. 493)</a>	40577-000011
<a href="#">MASIMO SpO2 Module Repair Kit (REF 40577-000039) (p. 494)</a>	40577-000039
<a href="#">MASIMO SpO2 Panel Mount Cable Repair Kit (REF 40577-000025) (p. 495)</a>	40577-000025
<a href="#">Temperature Cable Repair Kit (REF 40577-000040) (p. 496)</a>	40577-000040
<a href="#">OEM PCBA Repair Kit (REF 40577-000041) (p. 497)</a>	40577-000041
<a href="#">Interface PCBA Repair Kit, (REF 40577-000042) (p. 498)</a>	40577-000042
<a href="#">Power PCBA Repair Kit, V2/V4 (REF 40577-000043) (p. 499)</a>	40577-000043
<a href="#">System PCBA Repair Kit V4 (REF 40577-000031) (p. 500)</a>	40577-000031

### NIBP Module Repair Kit (REF 40577-000045)

Table 9.17—NIBP Module Repair Kit Parts

CAT.	Description	Notes
21330-001556	MODULE, NIBP, ROHS	
21300-006251	SCREW-M, PH, NYLOK, CS, 4-40, .250L	
21300-001038	SCREW-M, CS, Z, PH, NYLOCK, 4-40 X .312L	
21300-007297	SCREW-MACH, PNH, PHH, NYLOCK, 4-40, 0.312L, WSHR, CS, ZN	
21300-001416	SOCKET RETAINER CLIP - 10 PIN	
21300-007253	SCREW, CAP SCH, TORX, 6-32 X .375L, SS	
21300-000777	SCREW- 6-32 X .375	
21300-006965	SCREW-M PH, NYLOK 4-40 X .437	

### NIBP MAXIQ 5.2 Repair Kit (REF 40577-000036)

Table 9.18—NIBP Module Repair Kit Parts

CAT.	Description	Notes
21330-001528	MODULE, NIBP, MAXIQ, ROHS	
21300-006251	SCREW-M, PH, NYLOK, CS, 4-40, .250L	
21300-001038	SCREW-M, CS, Z, PH, NYLOCK, 4-40 X .312L	
21300-007297	SCREW-MACH, PNH, PHH, NYLOCK, 4-40, 0.312L, WSHR, CS, ZN	
21300-001416	SOCKET RETAINER CLIP - 10 PIN	
21300-007253	SCREW, CAP SCH, TORX, 6-32 X .375L, SS	
21300-000777	SCREW- 6-32 X .375	
21300-006965	SCREW-M PH, NYLOK 4-40 X .437	

### Invasive Pressure Connector Repair Kit (REF 40577-000034)

Table 9.19—IP Connector Repair Kit Parts List

CAT.	Description	Notes
21330-001526	WIRE HARNESS - INVASIVE PRESSURE 1 / 2	
21300-001315	GASKET - CONNECTOR, INVASIVE PRESSURE	
21300-007297	SCREW - MACH, PNH, PHH, NYLOCK, 4-40, 0.312L, WSHR, CS, ZN	
21300-007253	SCREW, CAP SCH, TORX, 6-32 X .375L, SS	
21300-000777	SCREW - 6-32 X .375	
21300-006965	SCREW-M PH, NYLOK 4-40 X .437	



### C02 Module Repair Kit (REF 40577-000035)

Table 9.20—C02 Module Parts List

CAT.	Description	Notes
21330-001535	MODULE, CO2, MINI	
21300-006251	SCREW-M, PH, NYLOK, CS, 4-40, .250L	
21300-001038	SCREW-M, CS, Z, PH, NYLOCK, 4-40 X .312L	
21300-007297	SCREW - MACH, PNH, PHH, NYLOCK, 4-40, 0.312L, WSHR, CS, ZN	
21300-001416	SOCKET RETAINER CLIP - 10 PIN	
21300-007253	SCREW, CAP SCH, TORX, 6-32 X .375L, SS	
21300-000777	SCREW - 6-32 X .375	
21300-006965	SCREW-M PH, NYLOK 4-40 X .437	

### Therapy PCBA Repair Kit (REF 40577-000032)

Table 9.21—Therapy PCBA Repair Kit Parts List

CAT.	Description	Notes
21330-001538	PCB ASSY - THERAPY, LIFEPAK15	
21300-001038	SCREW-M, CS, Z, PH, NYLOCK, 4-40 X .312L	
21300-007297	SCREW-MACH, PNH, PHH, NYLOCK, 4-40, 0.312L, WSHR, CS, ZN	
21300-007253	SCREW, CAP SCH, TORX, 6-32 X .375L, SS	
21300-000777	SCREW - 6-32 X .375	
21300-001379	HEADER, 30 PIN	

### Therapy Connector Repair Kit (REF 40577-000033)

Table 9.22—Therapy Connector Repair Kit Parts List

CAT.	Description	Notes
21330-001510	WIRE HARNESS - THERAPY RECEPTACLE	
21300-007464	GASKET	
21300-007253	SCREW - CAP, SCH, REC T15 TO RX 6-32, 32,0.375L,SS,NYL OK	
21300-000777	SCREW - 6-32 X .375	

### ECG Connector Repair Kit (REF 40577-000037)

Table 9.23—Hypertronics ECG Connector Repair Kit Parts List

CAT.	Description	Notes
N/A	ECG CABLE	
21300-002683	GASKET	
21300-007253	SCREW, CAP SCH, TORX, 6-32 X .375L, SS	
21300-000777	SCREW - 6-32 X .375	
21300-006965	SCREW-M PH, NYLOK 4-40 X .437	

### Display Driver Repair Kit (REF 40577-000001)

Table 9.24—Display Driver Repair Kit Parts List

CAT.	Description	Notes
21300-008138	DRIVER,LED, BACKLIGHT,12V DC,85C	
21300-001038	SCREW-M, CS, Z, PH, NYLOCK, 4-40 X .312L	
21300-007253	SCREW, CAP SCH, TORX, 6-32 X .375L, SS	
21300-000777	SCREW - 6-32 X .375	

### Display Repair Kit (REF 40577-00044)

Table 9.25—Display Repair Kit Parts List

CAT.	Description	Notes
21300-008140	DISPLAY, ACTIVE MATRIX, 8.4 IN, 262K COLOR	
21300-004599	SCREW, MACHINE, PANHEAD, NYLOK, 4-40 X .500	
21300-001038	SCREW-M, CS, Z, PH, NYLOK, 4-40 X .312L	
21300-007253	SCREW, CAP SCH, TORX, 6-32 X .375L, SS	
21300-000777	SCREW - 6-32 X .375	

### CO2 Connector Repair Kit (REF 40577-000038)

Table 9.26—CO2 Connector Repair Kit Parts List

CAT.	Description	Notes
21330-001529	FRS ASSEMBLY - CO2, MINI-MODULE, LIFEPAK15	
21300-007998	RETAINER - CO2 CONN	
21300-001314	SEAL - CO2 CONNECTOR	
21300-001548	ADAPTER - CO2 CONNECTOR	
21300-007353	SCREW - MACH, NYLOK, PNH, PHH, 2-56 X .500, CS, ZN	
21300-007445	CO2 CONNECTOR COVER	
21300-007253	SCREW, CAP SCH, TORX, 6-32 X .375L, SS	
21300-000777	SCREW - 6-32 X .375	
21300-006965	SCREW-M PH, NYLOK 4-40 X .437	

### Internal Hardware Repair Kit (REF 40577-000003)

Table 9.27—Internal Hardware Repair Kit Parts List

CAT.	Description	Notes
21300-001038	SCREW-M, CS, Z, PH, NYLOCK, 4-40 X .312L	
21300-007297	SCREW - MACH, PNH, PHH, NYLOCK, 4-40, 0.312L, WSHR, CS, ZN	
21300-001416	SOCKET RETAINER CLIP - 10 PIN	

### External Hardware Repair Kit (REF 40577-000004)

Table 9.28—External Hardware Repair Kit Parts List

CAT.	Description	Notes
21300-007253	SCREW, CAP SCH, TORX, 6-32 X .375L, SS	
21300-000777	SCREW - 6-32 X .375	
21300-006965	SCREW-M PH, NYLOK 4-40 X .437	

### Paddle Retainer Repair Kit (REF 40577-000005)

Table 9.29—Paddle Retainer Repair Kit Parts List

CAT.	Description	Notes
21330-001241	COVER - LATCH, PADDLE, GRAY	
21300-000777	SCREW,SELF-SEAL,SELF-LOCK,6-32X0.375	
21501-002043	LABEL SET-ECG,SPO2,NIBP,CO2,IP,ENGLISH	

### Display Shield Repair Kit (REF 40577-000006)

Table 9.30—Display Shield Repair Kit Parts List

CAT.	Description	Notes*
21330-001423	ASSEMBLY, DISPLAY SHIELD	
21300-007196	SCREW-MACH,TRH,T10 TORX,4-40,0.312L	

### Guard & Feet Repair Kit (REF 40577-000007)

Table 9.31—Guard & Feet Repair Kit Parts List

CAT.	Description	Notes
21300-007319	FOOT - MOUNTING	
21300-007010	GUARD, CORNER LOWER LEFT	
21300-007356	GUARD, LOWER RIGHT	
21300-007253	SCREW-CAP,SCH,REC T15 TO RX 6-32,0.375L,SS,NYLOK	

### Handle Repair Kit (REF 40577-000008)

Table 9.32—Handle Repair Kit Parts List

CAT.	Description	Notes
21300-007471	HANDLE	
21300-007469	HANDLE COVER PLATE, LEFT	
21300-007470	HANDLE COVER PLATE, RIGHT	
21300-000777	SCREW, 6-32 X .375	



### **NIBP Connector Repair Kit (REF 40577-000009)**

Table 9.33—NIBP Connector Repair Kit Parts List

CAT.	Description	Notes
21300-007425	CONNECTOR - PNEUMATIC COUPLER	
21300-007253	SCREW, CAP SCH, TORX, 6-32 X .375L, SS	
21300-000777	SCREW - 6-32 X .375	
21300-006965	SCREW-M PH, NYLOK 4-40 X .437	

### Front Case Repair Kit (REF 40577-000010)

Table 9.34—Front Case Repair Kit Parts List

CAT.	Description	Notes
21330-001273	ASSY - ENCLOSURE, FRONT	
21330-001173	LENS - DISPLAY	
21501-002038	LABEL - PHYSIO-CONTROL ICON	
21300-002394	SEAL - PERIMETER, CASE	
21300-004599	SCREW, MACHINE, PANHEAD, NYLOK, 4-40 X .500	
21300-001038	SCREW-M, CS, Z, PH, NYLOCK, 4-40 X .312L	
21300-007253	SCREW, CAP SCH, TORX, 6-32 X .375L, SS	
21300-000777	SCREW - 6-32 X .375	
21300-006965	SCREW-M PH, NYLOK 4-40 X .437	
21300-007464	SEAL - THERAPY CONNECTOR	
21300-007196	SCREW - MACHINE, TRH, T10 TORX (R), 4-40, SS	

### Rear Case Repair Kit (REF 40577-000011)

Table 9.35—Rear Case Repair Kit Parts List

CAT.	Description	Notes
21330-001272	ASSY - ENCLOSURE, REAR	
21330-001190	FLEXIBLE GROUND PLANE - EMI SHIELD	
21300-000203	AUX/SERIAL CONNECTOR O-RINGS	
21300-002023	CONN - PLUG, BANANA PIN	
21300-000504	TIE WRAP, LG	
21300-000499	CABLE TIES, SM	
21300-001038	SCREW-M, CS, Z, PH, NYLOCK, 4-40 X .312L	
21300-000777	SCREW - 6-32 X .375	
21300-006965	SCREW-M PH, NYLOK 4-40 X .437	
21300-007253	SCREW, CAP SCH, TORX, 6-32 X .375L, SS	
21300-007297	SCREW - MACH, PNH, PHH, NYLOCK, 4-40, 0.312L, WSHR, CS, ZN	
21300-001416	SOCKET RETAINER CLIP - 10 PIN	

### MASIMO SpO2 Module Repair Kit (REF 40577-000039)

Table 9.36—MASIMO SpO2 Module Parts List

CAT.	Description	Notes
21300-006251	SCREW-M, PH, NYLOK, CS, 4-40 x 0.250	
21300-001038	SCREW-M, PH, NYLOK, CS, 4-40 x 0.312	
21300-006965	SCREW-M, PH, NYLOK, CS, 4-40 x 0.437	
21300-004599	SCREW-M, PH, NYLOK, CS, 4-40 x 0.500	
21330-001530	MODULE - OEM, PULSE OXIMETER, MX-51, ROHS	
21300-000777	SCREW - PANHEAD, PHILLIPS, STAINLESS STEEL, SELF-SEALING, SELF-LOCKING	
21300-007253	SCREW - CAP, SCH, REC T15 TORX 6-32, 0.375L, SS, NYLOK	
21300-001416	SOCKET - RETAINER CLIP	
21300-007297	SCREW - MACHINE, PNH, PHH, 4-40, NYLOK, CS, WITH WASHER	

### MASIMO SpO2 Panel Mount Cable Repair Kit (REF 40577-000025)

Table 9.37—MASIMO SpO2 Panel Mount Cable Parts List

CAT.	Description	Notes
21330-001290	CABLE ASSY - FLEX, SPO2, MASIMO	
21300-007557	SCREW, MACHINE, PAN, TORX, NYLOK, 4-40 X .687	
21300-006965	SCREW, MACHINE, PANHEAD, NYLOK, 4-40 X .437	
21300-000777	SCREW - PANHEAD, PHILLIPS, STAINLESS STEEL, SELF-SEALING, SELF-LOCKING	
21300-007253	SCREW - CAP, SCH, REC T15 TORX 6-32, 0.375L, SS, NYLOK	
21300-001416	SOCKET - RETAINER CLIP	
21300-007112	HOUSING - FERRITE, SPO2	
21300-007297	SCREW - MACHINE, PNH, PHH, 4-40, NYLOK, CS, WITH WASHER	

### Temperature Cable Repair Kit (REF 40577-000040)

Table 9.38—Temperature Cable Repair Kit Parts List

CAT.	Description	Notes
21300-007253	SCREW, CAP, SCH, REC T15 TORX 6-32, 0.375L, SS, NYLOK	
21300-000777	SCREW, SELF-SEAL, SELF-LOCK, 6-32 X 0.375	
21300-006965	SCREW, MACHINE, PANHEAD, NYLOK, 4-40 X .437	
21300-007297	SCREW, MACH, PNH, PHH, NYLOCK, 4-40, 0.312L, WSHR, CS, ZN	
21330-001522	CABLE ASSEMBLY - TEMPERATURE	
21300-001315	GASKET - CONNECTOR, INVASIVE PRESSURE	

### OEM PCBA Repair Kit (REF 40577-000041)

Table 9.39—OEM PCBA Repair Kit Parts List

CAT.	Description	Notes
21300-007253	SCREW, CAP, SCH, REC T15 TORX 6-32, 0.375L, SS, NYLOK	
21300-007297	SCREW, MACH ,PNH, PHH, NYLOCK, 4-40, 0.312L, WSHR, CS, ZN	
21300-001416	SOCKET RETAINER CLIP - 10 PIN	
21300-006965	SCREW, MACH, PANHEAD, NYLOK, 4-40 X .437	
21300-001038	SCREW-M, CS, Z, PH, NYLOCK, 4-40 X .312L	
21300-000777	SCREW, SELF-SEAL, SELF-LOCK, 6-32 X 0.375	
21330-001532	PCB ASSY - OEM	

### Interface PCBA Repair Kit, (REF 40577-000042)

Table 9.40—Interface PCBA Repair Kit Parts List

CAT.	Description	Notes
21330-001533	PCB ASSY - INTERFACE, LP15 V2	
21300-007253	SCREW, CAP, SCH, REC T15 TORX 6-32, 0.375L, SS, NYLOK	
21330-001226	CABLE ASSY - FLEX, SYSTEM PCB/INTERFACE PCB	
21300-001038	SCREW-M, CS, Z, PH, NYLOCK, 4-40 X .312L	
21300-000777	SCREW, SELF-SEAL, SELF-LOCK, 6-32 X 0.375	



### Power PCBA Repair Kit, V2/V4 (REF 40577-000043)

Table 9.41—V2/V4 Power PCBA Repair Kit Parts List

CAT.	Description	Notes
21330-001555	PCB ASSY - POWER, LP15	
21300-007253	SCREW - CAP, SCH, REC T15 TORX 6-32, 0.375L, SS, NYLOK	
21300-007297	SCREW, MACH, PNH, PHH, NYLOCK, 4-40, 0.312L, WSHR, CS, ZN	
21300-001416	SOCKET RETAINER CLIP - 10 PIN	
21300-006965	SCREW, MACH, PANHEAD, NYLOK, 4-40 X .437	
21300-001038	SCREW-M, CS, Z, PH, NYLOCK, 4-40 X .312L	
21300-000777	SCREW, SELF-SEAL, SELF-LOCK, 6-32 X 0.375	

### System PCBA Repair Kit V4 (REF 40577-000031)

Table 9.42—System PCBA Repair Kit Parts List

CAT.	Description	Notes
21300-001379	CONNECTOR - HDR, SQUARE PIN, DUAL ROW, 30 PIN	
21300-001038	SCREW - MACHINE, PANHEAD, NYLOK	
21300-007297	SCREW - MACHINE, PNH, PHH, 4-40, NYLOCK, CS, WITH WASHER	
21300-007253	SCREW - CAP, SCH, REC T15 TORX 6-32, 0.375L, SS, NYLOK	
21300-000777	SCREW - PANHEAD, PHILLIPS, STAINLESS STEEL, SELF-SEALING, SELF-LOCKING	
21330-001539	PCB ASSY - SYSTEM, LP15	

### Defibrillator Part Number and Serial Number

#### PN and SN Label

The LIFEPAK 15 monitor/defibrillator serial number (SN) and part number (PN) are noted on a label on the rear case assembly in Battery Well 1.

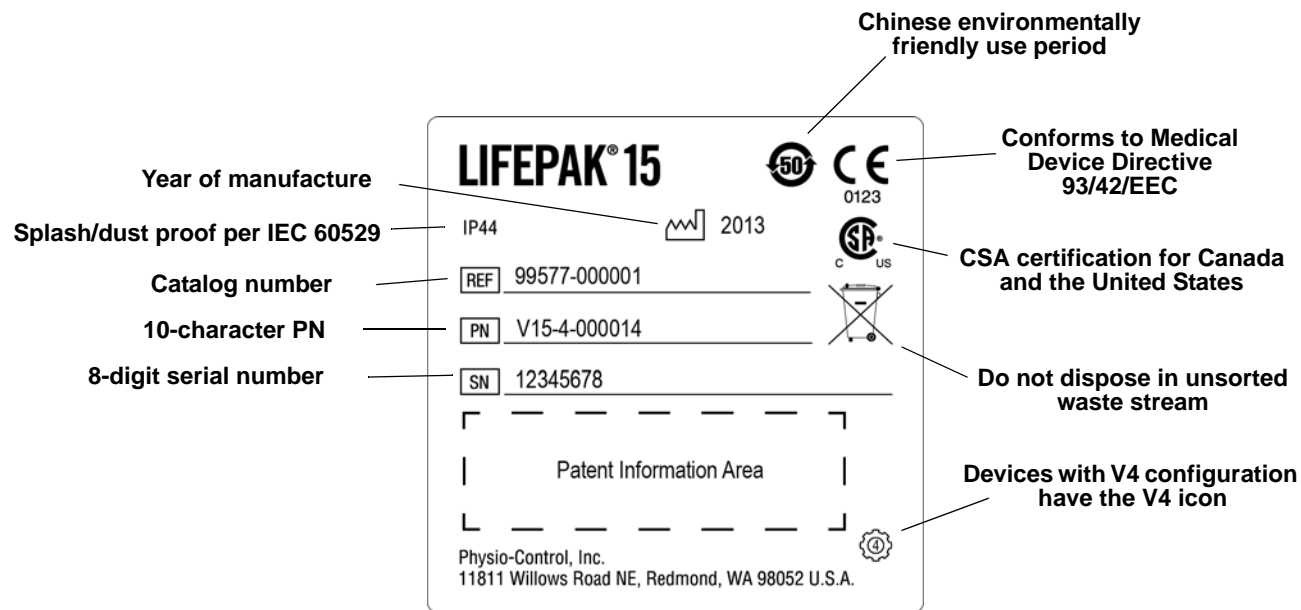

#### Understanding the Part Number

The device part number, for example, V15-4-000014, reflects the device options, features, and language.

### Understanding the Serial Number

The serial number for the LIFEPAK 15 monitor/defibrillator is related to the sales order created during device manufacturing and appears on the serial number label in Battery Well 1. Use this number when calling to order parts.

### Ordering Parts

To order parts, contact your local Physio-Control representative. In the USA, call PARTSLINE™ at 1.800.442.1142. Provide the part number and serial number located on the device label in Battery Well 1. Specify all assembly numbers, catalog numbers, reference designations, and descriptions. Parts may be substituted to reflect device modifications and improvements.

### Manufacturing Date

In some cases when ordering parts, you may also need the device manufacturing date. The date of manufacture is available by accessing the Service/Status/Device Data as described in [Device Data \(p. 108\)](#).

### Serial Number

The serial number of the device identifies the manufacturing conditions and elements used in producing your device. When ordering parts, use the serial number (SN) listed on the label in Battery Well 1.

# Index

## Numerics

12-lead button function [60](#)

12-lead ECG accessories [65](#)

## A

A01 system PCB, see system PCB (A10)

A03 power PCB, see power PCB (A03)

A04 therapy PCB, see therapy PCB (A04)

A05 interface PCB, see interface PCB (A05)

A06 OEM PCB, see OEM PCB (A06)

A07 contact PCB, see contact PCB (A07)

A08 backlight PCB, see backlight PCB (A08)

A09 printer control keypad, see printer control keypad (A09)

A10 main keypad, see main keypad (A10)

A11 LCD assembly, see LCD assembly (A11)

A12 printer assembly, see printer assembly (A12)

A13 transfer relay assembly, see transfer relay assembly (A)

A14 inductive resistor, see inductive resistor (A14)

A15 energy storage capacitor, see energy storage capacitor (A15)

A16 SpO2 module, see SpO2 module (A16)

A17 interconnect bracket, see interconnect bracket (A17)

A21 NIBP module, see NIBP module (A21)

A22 biphasic module, see biphasic module (A22)

A23 CO2 module, see CO2 module (A23)

acronyms [25](#)

Adobe Reader [13](#)

AED mode

definition [50](#)

setup [89](#)

ALARMS button function [56](#)

ANALYZE button function [56](#)

archive mode [95](#)

auxiliary connector cable (W09)

replacing [317](#)

## B

backlight PCB (A08)

description [83](#)

diagram [439](#)

replacing [197](#)

backlight PCB/interface PCB cable (W06)

diagram [454](#)

replacing [216](#)

batteries

charger accessories [66](#)

charging [167](#)

coin [171](#)

description [162](#)

discarding/recycling [168](#)

fuel gauge [164](#)

maintenance [161](#)

new [170](#)

performance characteristics [166](#)

status indicators [163](#)

storing [169](#)

battery compartments description [62](#)

battery pins

replacing [350](#)

battery pins/power PCB cable (W10)

diagram [458](#)

replacing [320](#)

## C

cable

backlight PCB/interface PCB cable (W06)  
diagram [454](#)

battery pins/power PCB (W10) [458](#)

CO2 inlet connector (W28) [473](#)

CO2 module adapter (W29) [474](#)

ECG connector cable (W07) diagram [455](#)

LCD assembly/interface PCB (W18) [466](#)

main keypad/interface PCB cable (W13) [461](#)

OEM PCB/NIBP module (W27) [472](#)

OEM PCB/SpO2 module (W21) [468](#)

power PCB/contact PCB (W05) diagram [453](#)

power PCB/system PCB (W01) diagram [449](#)

power PCB/therapy PCB (W02) diagram [450](#)

printer assembly/chassis ground (W19) [467](#)

printer assembly/interface PCB (W16) [464](#)

printer control keypad/interface PCB (W12) [460](#)

SpO2 connector (W22) [469](#)

system connector (W08) [456, 457](#)

system PCB/interface PCB (W04) [452](#)

therapy connector (W11) [459](#)

Canadian Standards Association [39](#)

capacitor discharge tool [180](#)

CHARGE button function [57](#)

cleaning

- exterior [156](#)
- tools and materials [155](#)
- clearing data management memory [116](#)
- CO2
  - diagram [398](#)
  - parts list [400](#)
- CO2 connector cable (W28)
  - description [86](#)
  - diagram [473](#)
  - replacing [336](#)
- CO2 module (A23)
  - description [84](#)
  - diagram [447](#)
  - exhaust port [62](#)
  - repair kit [482](#)
  - replacing [281](#)
- CO2 module adapter cable (W29)
  - diagram [474](#)
- coin battery
  - description [171](#)
  - replacing [348](#)
- configuration options [22](#)
- contact PCB (A07)
  - description [83](#)
  - diagram [438](#)
  - replacing [345](#)
- contacting Physio-Control [16](#)
- corrective action codes [141](#)
- counters [114](#)
- CPR button function [56](#)
- CURRENT button function [57](#)

## D

- data management memory, clearing [116](#)
- data management options [67](#)
- demo mode [94](#)
- device log [106](#)
- device self tests [148](#)
- device tracking [18](#)
- device user test [149](#)
- diagram
  - assembly configurator [354](#)
  - backlight PCB (A08) [439](#)
  - backlight PCB/interface PCB cable (W06) [454](#)
  - battery pins/power PCB cable (W10) [458](#)
  - CO2 [398](#)
  - CO2 inlet connector cable (W28) [473](#)
  - CO2 module (A23) [447](#)
  - CO2 module adapter cable (W29) [474](#)
  - contact PCB (A07) [438](#)
  - ECG connector cable (W07) [455](#)
  - energy storage capacitor (A15) [444](#)
  - external front connections [70](#)
  - external parts [359](#)
  - front [364](#)
  - front panel features [54](#)
  - inside front case [191](#)
  - inside rear case [231](#)
  - interconnect [354](#)
  - interface PCB (A05) [436](#)
  - invasive pressure connection [71](#)
  - invasive pressure connector assembly (W33)
    - [475](#), [476](#)
  - LCD assembly [442](#)

- LCD assembly/interface PCB cable (W18) [466](#)
- main keypad (A10) [441](#)
- main keypad/interface PCB cable (W13) [461](#)
- NIPB [398](#)
- NIPB module (A21) [446](#)
- OEM PCB (A06) [437](#)
- OEM PCB/NIPB module cable (W27) [472](#)
- OEM PCB/SpO2 module cable (W21) [468](#)
- parameter bezel [379](#)
- power PCB (A03) [434](#)
- power PCB/contact PCB cable (W05) [453](#)
- power PCB/system PCB cable (W01) [449](#)
- power PCB/therapy PCB cable (W02) [450](#)
- printer assembly [443](#)
- printer assembly/chassis ground cable (W19)
  - [467](#)
- printer assembly/interface PCB cable (W16) [464](#)
- printer control keypad (09) [440](#)
- printer control keypad/interface PCB cable (W12)
  - [460](#)
- rear [386](#)
- rear panel features [61](#)
- speaker assembly (W17) [465](#)
- speed dial assembly (W15) [462](#), [463](#)
- SpO2 [398](#)
- SpO2 connector cable (W22) [469](#)
- SpO2 module (A16) [445](#)
- system block [75](#)
- system PCB (A01) [433](#)
- system PCB/interface PCB cable (W04) [452](#)
- system PCB/therapy PCB connector (W03) [451](#)
- system/therapy assembly [374](#)
- therapy connector cable (W11) [459](#)

- therapy PCB (A01) [435](#)
- discharging the energy storage capacitor [181](#)
- DISPLAY MODE button function [58](#)
- document CD
  - Adobe Reader [13](#)
  - navigation instructions [14](#)

**E**

- ECG
  - connection port [60](#)
- ECG connector cable (W07)
  - description [84](#)
  - diagram [455](#)
  - replacing [314](#)
- electrode options [66](#)
- EMI shield
  - replacing [291](#)
- ENERGY SELECT button function [57](#)
- energy storage capacitor (A15)
  - diagram [444](#)
  - replacing [268](#)
- energy storage capacitor, discharging [181](#)
- error codes
  - categories [117](#)
  - processing [113](#)
- EVENT button function [57](#)
- Event marker [41](#)
- external parts
  - diagram [359](#)
  - parts list [361](#)

**F**

- front

- diagrams [364](#)
- parts list [368](#)
- front case
  - inside diagram [191](#)
  - replacing [211](#)
- front panel features [54](#)

**G**

- glossary [23](#)

**H**

- Heart rate/pulse rate indicator [37](#)
- HOME SCREEN button function [57](#)

**I**

- inside front case diagram [191](#)
- interconnect diagram [354](#)
- interface PCB (A05)
  - description [81](#)
  - diagram [436](#)
  - replacing [192](#)
- invasive pressure
  - connection ports [60](#)
  - repair kit [481](#)
- invasive pressure connector assembly (W33)
  - description [86](#)
  - diagram [475, 476](#)
  - replacing [341](#)

**L**

- labels, SN/PN [500](#)
- LCD assembly (A11)
  - description [83](#)

- diagram [442](#)
- replacing [206](#)
- LCD assembly/interface PCB cable (W18)
  - diagram [466](#)
  - replacing [229](#)
- LEAD button function [56](#)
- LIFEPAK 12
  - reassembling the case [186](#)
  - software and device upgrades [351](#)
- LIFEPAK 15
  - assemblies [52](#)
  - basic components [63](#)
  - carrying bags [67](#)
  - cleaning [155](#)
  - configuration options [22](#)
  - description [48](#)
  - device tracking [18](#)
  - energy delivery definition [49](#)
  - environmental conditions [158](#)
  - external front connections [70](#)
  - front panel features [54](#)
  - functional descriptions [73](#)
  - invasive pressure connection [71](#)
  - maintenance [147](#)
  - manufacturing date [501](#)
  - optional features [64](#)
  - options, supplies, and accessories [64](#)
  - pacing waveform definition [50](#)
  - part number [500](#)
  - primary functions [50](#)
  - rear panel features [61](#)
  - serial number [500](#)
  - service technician qualifications [15](#)

- support policy [154](#)
- useful life [153](#)
- user test [150](#)
- waveform technology [49](#)

## M

- main keypad (A10)
  - description [83](#)
  - diagram [441](#)
  - replacing [202](#)
- main keypad/interface PCB cable (W13)
  - diagram [461](#)
  - replacing [220](#)
- MAINTENANCE DUE message [152](#)
- maintenance prompt interval setup [152](#)
- manual mode
  - accessing [88](#)
  - definition [50](#)
- manufacturing date [501](#)
- modes of operation [87](#)

## N

- navigation
  - using Adobe Reader [13](#)
  - using hyperlinks [14](#)
- NIBP
  - connector function [60](#)
  - connector replacement [292](#)
  - diagram [398](#)
  - parts list [399](#)
- NIBP module (A21)
  - description [84](#)
  - diagram [446](#)

- repair kit [479](#)
- replacing [281](#)

## O

- OEM PCB (A06)
  - description [82](#)
  - diagram [437](#)
  - replacing [261](#)
- OEM PCB/CO2 module cable (W26)
  - replacing [332](#)
- OEM PCB/NIBP module cable (W27)
  - diagram [472](#)
  - replacing [334](#)
- OEM PCB/SpO2 module cable (W21)
  - diagram [468](#)
  - replacing [327](#)
- optional features [64](#)
- OPTIONS button function [57](#)
- ordering parts [501](#)
  - manufacturing date [501](#)

## P

- Pace arrow
  - Internal pacing [41](#)
  - Noninvasive pacing [41](#)
- PACER button function [57](#)
- paddles
  - storage [62](#)
- parameter bezel
  - diagrams [379](#)
  - parts list [383](#)
  - replacing [295](#)
- parts
  - ordering [501](#)
- parts list
  - CO2 [400](#)
  - external parts [361](#)
  - front [368](#)
  - NIBP [399](#)
  - parameter bezel [383](#)
  - printer control keyboard language [402](#)
  - product ID label language [408](#)
  - rear [393](#)
  - SpO2 [399](#)
  - system/therapy assembly
    - [376](#)
- PAUSE button function [58](#)
- power options [66](#)
- power PCB (A03)
  - description [78](#)
  - diagram [434](#)
  - replacing [250](#)
- power PCB/contact PCB cable (W05)
  - diagram [453](#)
  - replacing [312](#)
- power PCB/system PCB cable (W01)
  - diagram [449](#)
  - replacing [309](#)
- power PCB/therapy PCB cable (W02)
  - diagram [450](#)
  - replacing [310](#)
- preventive maintenance [147](#)
  - testing schedule [150](#)
- printer assembly (A12)
  - description [83](#)
  - diagram [443](#)



- maintenance [159](#)
- printer paper [68](#)
- replacing [346](#)
- printer assembly/chassis ground cable (W19)
  - diagram [467](#)
  - replacing [230](#)
- printer assembly/interface PCB cable (W16)
  - diagram [464](#)
  - replacing [224](#)
- printer control keypad (A09)
  - diagram [440](#)
  - language parts list [402](#)
  - replacing [200](#)
- printer control keypad/interface PCB cable (W12)
  - diagram [460](#)
  - replacing [219](#)
- printer paper [68](#)

## R

- RATE button function [57](#)
- rear
  - diagrams [386](#)
  - parts list [393](#)
- rear case
  - diagrams [231](#)
  - replacing [301](#)
- rear panel features [61](#)
- recycling
  - batteries [168](#)
  - general information [20](#)
- repair kit
  - CO2 module [482](#)
  - invasive pressure connector [481](#)

- list of all kits [477](#)
- NIBP module (A21) [479](#)
- replacement procedures [172](#)
  - tools needed [179](#)
  - warnings and cautions [176](#)
- replacing [343](#)
- responsibility for information [17](#)
- R-wave sense marker [41](#)

## S

- safety
  - introduction [29](#)
- scheduled replacement items [151](#)
- service information [19](#)
- service LED [145](#)
- service LED function [56](#)
- service log [111](#)
- setup configuration
  - saving and restoring [182](#)
- Setup mode [90](#)
- SHOCK button function [57](#)
- SIZE button function [56](#)
- speaker assembly (W17)
  - description [86](#)
  - diagram [465](#)
  - replacing [226](#)
- speed dial assembly (W15)
  - description [85](#)
  - diagram [462, 463](#)
  - replacing [221](#)
- SPEED DIAL function [58](#)
- SpO2
  - diagram [398](#)
  - parts list [399](#)
- SpO2 connector cable (W22)
  - description [86](#)
  - diagram [469](#)
  - replacing [329](#)
- SpO2 module (A16)
  - description [84](#)
  - diagram [445](#)
  - replacing [271](#)
- status menu [104](#)
- symbols [36](#)
- SYNC button function [56](#)
- system block diagram [75](#)
- system connector cable
  - description [85](#)
- system connector cable (W08) [456, 457](#)
  - diagram [456, 457](#)
  - replacing [317](#)
- system connector definition [62](#)
- system PCB (A01)
  - description [76](#)
  - diagram [433](#)
- system PCB/interface PCB cable (W04)
  - diagram [452](#)
  - replacing [215](#)
- system PCB/therapy PCB connector (W03)
  - diagram [451](#)
- system/therapy assembly
  - diagrams [374](#)
  - parts list [376](#)
- system/therapy PCBs
  - replacing [234](#)

**T**

Temperature Cable Assembly (W34) [343](#)

terms [30](#)

therapy cable receptacle function [60](#)

therapy connector cable (W11)

description [85](#)

diagram [459](#)

replacing [217](#)

therapy delivery options [65](#)

therapy PCB (A04)

description [79](#)

diagram [435](#)

trademarks [12](#)

training/testing tools [67](#)

troubleshooting

clearing memory [116](#)

corrective actions [97](#)

corrective action codes [141](#)

counters [114](#)

device log [106](#)

error code categories [117](#)

introduction [96](#)

pixels test [146](#)

processing error codes [113](#)

service LED [145](#)

service log [111](#)

user test [150](#)

W15, see speed dial assembly (W15)

W17, see speaker assembly (W17)

W22, see SpO2 connector cable (W22)

W28, see CO2 inlet connector cable (W28)

W33, see IP connector cable (W33)

warnings and cautions

replacement procedures [176](#)

safety [31](#)

warranty [21](#)

**W**

W07, see ECG connector cable (W07)

W08, see system connector cable (W08)

W11, see therapy connector cable (W11)

# LIFEPAK<sup>®</sup> 15 MONITOR/DEFIBRILLATOR

---

## Service Manual

For further information, please call Physio-Control at 1.800.442.1142 or visit [www.physio-control.com](http://www.physio-control.com)



**Physio-Control Headquarters**  
11811 Willows Road NE  
Redmond, WA 98073-9708 USA  
Tel: 425.867.4000  
Fax: 425.458.1404  
[www.physio-control.com](http://www.physio-control.com)

**Stryker Australia Pty Ltd**  
8 Herbert Street  
St Leonards  
NSW 2065  
Australia



**Physio-Control, Inc.**, 11811 Willows Road NE, Redmond, WA 98052 USA



**Stryker European Operations B.V.**, Herikerbergweg 110, 1101 CM Amsterdam, The Netherlands

© 2019 Physio-Control, Inc. Specifications are subject to change without notice.

Publication Date: 03/2019

**PN** 3316924-004